

MITSUBISHI

A1SD75P1-S3/P2-S3/P3-S3
AD75P1-S3/P2-S3/P3-S3 Positioning Module

User's Manual

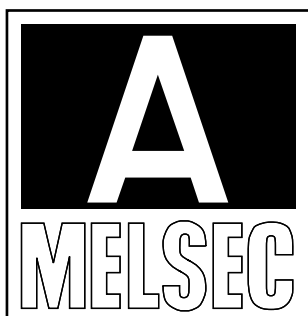
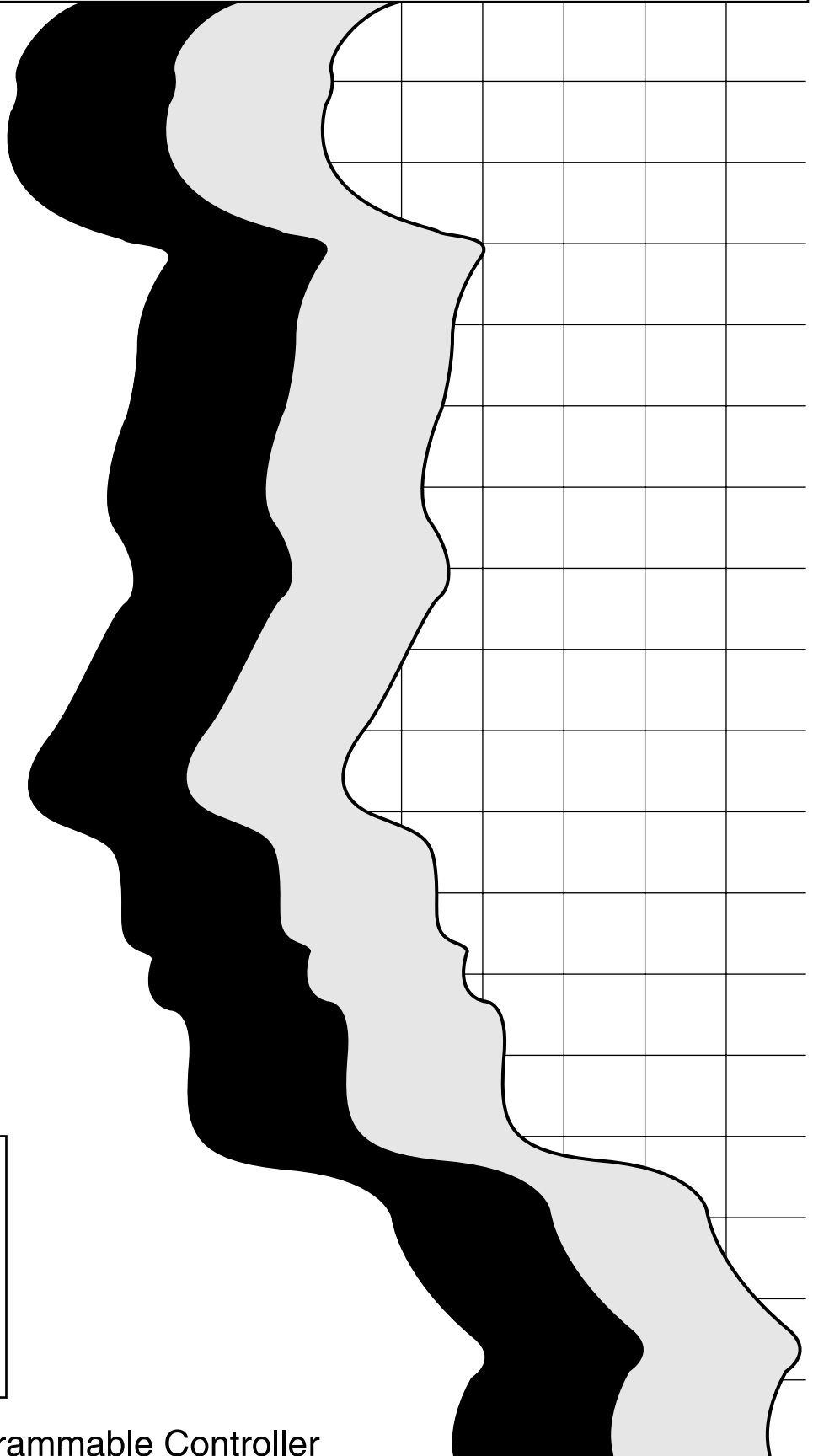

Mitsubishi Programmable Controller

● SAFETY INSTRUCTIONS ●

(Always read these instructions before using this equipment.)

Before using this product, please read this manual and the relevant manuals introduced in this manual carefully and pay full attention to safety to handle the product correctly.

The instructions given in this manual are concerned with this product. For the safety instructions of the programmable controller system, please read the CPU module User's Manual.

In this manual, the safety instructions are ranked as "DANGER" and "CAUTION".



Indicates that incorrect handling may cause hazardous conditions, resulting in death or severe injury.



Indicates that incorrect handling may cause hazardous conditions, resulting in medium or slight personal injury or physical damage.

Note that the  CAUTION level may lead to a serious consequence according to the circumstances. Always follow the instructions of both levels because they are important to personal safety.

Please save this manual to make it accessible when required and always forward it to the end user.

[Design Instructions]

DANGER

- Provide a safety circuit outside the programmable controller so that the entire system will operate safely even when an external power supply error or PLC fault occurs.
Failure to observe this could lead to accidents for incorrect outputs or malfunctioning.
 - (1) Configure an emergency stop circuit and interlock circuit such as a positioning upper limit/lower limit to prevent mechanical damage outside the PLC.
 - (2) The machine zero point return operation is controlled by the zero point return direction and zero point return speed data. Deceleration starts when the near-point dog turns ON. Thus, if the zero point return direction is incorrectly set, deceleration will not start and the machine will continue to travel. Configure an interlock circuit to prevent mechanical damage outside the PLC.
 - (3) When the module detects an error, normally deceleration stop or sudden stop will take place according to the parameter stop group settings. Set the parameters to the positioning system specifications.
Make sure that the zero point return parameter and positioning data are within the parameter setting values.

[Design Instructions]

CAUTION

- Do not bundle or adjacently lay the control wire or communication cable with the main circuit or power wire.
Separate these by 100mm or more.
Failure to observe this could lead to malfunctioning caused by noise.

[Mounting Instructions]

CAUTION

- Use the PLC within the general specifications environment given in this manual.
Using the PLC outside the general specification range environment could lead to electric shocks, fires, malfunctioning, product damage or deterioration.
- Always securely insert the module latches at the bottom of the module into the fixing holes on the base unit. (Always screw the AnS Series module onto the base unit with the specified torque.)
Improper mounting of the module could lead to malfunctioning, faults or dropping.
- Securely connect the external device connection connector and peripheral device connection connector into the module connector until a click is heard.
Improper connection could lead to a connection fault, and to incorrect inputs and outputs.
- When not connecting the drive unit, always install a cover on the connector section.
Failure to observe this could lead to malfunctioning.

[Wiring Instructions]

DANGER

- Always confirm the terminal layout before connecting the wires to the module.
- Make sure that foreign matter such as cutting chips and wire scraps does not enter the module.
Failure to observe this could lead to fires, faults or malfunctioning.

[Startup/Maintenance Instructions]

DANGER

- Switch off all phases of the externally supplied power used in the system before cleaning or tightening the screws.
Failure to turn all phases OFF could lead to electric shocks.

[Startup/Maintenance Instructions]

CAUTION

- Never disassemble or modify the module.
Failure to observe this could lead to trouble, malfunctioning, injuries or fires.
- Switch off all phases of the externally supplied power used in the system before installing or removing the module.
Failure to turn all phases OFF could lead to module trouble or malfunctioning.
- Before starting test operation, set the parameter speed limit value to the slowest value, and make sure that operation can be stopped immediately if a hazardous state occurs.
- Always make sure to touch the grounded metal to discharge the electricity charged in the body, etc., before touching the module.
Failure to do so may cause a failure or malfunctions of the module.

[Precautions for use]

CAUTION

- Note that when the reference axis speed is designated for interpolation operation, the speed of the partner axis (2nd axis) may be larger than the set speed (larger than the speed limit value).

[Disposal Instructions]

CAUTION

- When disposing of the product, handle it as industrial waste.

REVISIONS

* The manual number is given on the bottom left of the back cover.

Print Date	* Manual Number	Revision
Feb., 1997	IB (NA) -66716-A	Initial print
Jul., 1997	IB (NA) -66716-B	Complete review
Nov., 1997	IB (NA) -66716-C	<p>Additional functions</p> <p>Section 4.2.7 (Initializing the parameters), Section 4.3.3 (5) (Near pass mode for continuous path control in interpolation control)</p> <p>Partial revisions and additions</p> <p>Section 3.2.2 (Table), Section 4.2.1 (2), Section 4.2.9, Fig. 4.10, Section 4.4.2, Section 4.7.2, Section 4.13, Chapter 5, Section 5.2.2 (3), Table 6.1, Section 18.1, Section 18.2, Appendix 5.4</p> <p>Chapter addition</p> <p>Chapter 1</p>
Oct., 1999	IB (NA) -66716-D	Complete review
Sep., 2002	IB (NA) -66716-E	Complete review
May, 2003	IB (NA) -66716-F	Complete review
Feb., 2004	IB (NA) -66716-G	<p>Partial revisions and additions</p> <p>CONTENTS, Section 1.1.1, Section 1.2.3, Section 2.2, Section 3.4.2, Section 3.5.1, Section 3.5.3, Section 5.2.5, Section 5.3 to Section 5.5, Section 5.6.2, Section 6.5.3, Section 6.5.6, Section 7.1.2, Section 8.2.5, Section 8.2.6, Section 9.1.2, Section 9.1.5, Section 9.2.3 to Section 9.2.5, Section 9.2.8, Section 10.1.2, Section 10.3.3 to Section 10.3.5, Section 10.3.8, Section 11.1.1, Section 11.2.1, Section 11.3.1, Section 11.3.3, Section 12.2.1, Section 12.2.2, Section 12.4.4, Section 12.5.1, Section 14.2, Appendix 10 to Appendix 12, INDEX</p>
Dec., 2004	IB (NA) -66716-H	<p>Partial revisions and additions</p> <p>SAFETY INSTRUCTIONS, Section 4.2.1, Section 4.3.1 to Section 4.3.3, Section 4.4.2, Section 4.5.1, Section 5.1.2, Section 5.2.1, Section 5.3, Section 5.6.2, Section 6.1, Section 8.1.1, Section 8.2.4, Section 8.2.5, Section 8.2.8, Section 8.2.9, Section 8.3, Section 8.4, Section 9.1.2, Section 9.1.5, Section 9.2.6, Section 9.2.11, Section 10.3.9, Section 11.3.1, Section 12.2.1, Section 12.4.3, Section 12.4.4, Section 12.6.1, Section 12.6.6, Section 13.4, Section 14.1, Section 14.2, Appendix 12</p>

* The manual number is given on the bottom left of the back cover.

Print Date	* Manual Number	Revision
Jul., 2006	IB (NA) -66716-I	<div data-bbox="639 264 1002 297" style="border: 1px solid black; padding: 2px;">Partial revisions and additions</div> <p data-bbox="639 327 1406 360">CONTENTS, Section 5.2.1, Section 12.6.1, Appendix 6.1, INDEX</p>
Sep., 2007	IB(NA)-66716-J	<div data-bbox="639 387 855 421" style="border: 1px solid black; padding: 2px;">Partial revisions</div> <p data-bbox="639 450 1366 584">Section 3.4.2, Section 5.1.2, Section 5.6.1, Section 5.7.1, Section 6.5.3, Section 6.5.5, Section 9.1.2, Section 9.2.9, Section 9.2.10, Section 10.3.2, Section 10.5.1, Section 12.5.1, Section 12.5.2, Section 12.6.1, Section 12.6.2, Section 12.6.8</p>

Japanese Manual Version SH-3608-M

This manual confers no industrial property rights or any rights of any other kind, nor does it confer any patent licenses. Mitsubishi Electric Corporation cannot be held responsible for any problems involving industrial property rights which may occur as a result of using the contents noted in this manual.

INTRODUCTION

Thank you for purchasing the Mitsubishi general-purpose programmable controller MELSEC-A Series. Always read through this manual, and fully comprehend the functions and performance of the A Series PLC before starting use to ensure correct usage of this product.

CONTENTS

SAFETY INSTRUCTIONS.....	A-1
REVISIONS.....	A-4
INTRODUCTION.....	A-6
CONTENTS.....	A-6
About Manuals	A-14
Conformation to the EMC Directive and Low Voltage Instruction	A-14
Using This Manual (1).....	A-15
Using This Manual (2).....	A-16
Using This Manual (3).....	A-17
Generic Terms and Abbreviations.....	A-18
Enclosed Parts	A-19

SECTION 1 PRODUCT SPECIFICATIONS AND HANDLING

1. PRODUCT OUTLINE 1-1 to 1-18

1.1 Positioning control.....	1-2
1.1.1 Features of AD75	1-2
1.1.2 Purpose and applications of positioning control.....	1-4
1.1.3 Mechanism of positioning control	1-6
1.1.4 Outline design of positioning system.....	1-8
1.1.5 Communicating signals between AD75 and each module	1-10
1.2 Flow of system operation.....	1-12
1.2.1 Flow of all processes.....	1-12
1.2.2 Outline of starting	1-14
1.2.3 Outline of stopping	1-16
1.2.4 Outline for restarting.....	1-17

2. SYSTEM CONFIGURATION 2-1 to 2-8

2.1 General image of system.....	2-2
2.2 List of configuration devices	2-4
2.3 Applicable system	2-5
2.4 Precautions for configuring system	2-6

3. SPECIFICATIONS AND FUNCTIONS 3-1 to 3-22

3.1 General specifications.....	3-2
3.2 Performance specifications.....	3-3
3.3 List of functions	3-4
3.3.1 AD75 control functions.....	3-4
3.3.2 AD75 main functions	3-6

3.3.3 AD75 auxiliary functions and common functions	3-8
3.3.4 Combination of AD75 main functions and auxiliary functions	3-10
3.4 Specifications of input/output signals with PLC CPU	3-12
3.4.1 List of input/output signals with PLC CPU	3-12
3.4.2 Details of input signals (AD75 → PLC CPU)	3-13
3.4.3 Details of output signals (PLC CPU → AD75)	3-15
3.5 Specifications of input/output interfaces with external devices	3-16
3.5.1 Electrical specifications of input/output signals	3-16
3.5.2 Signal layout for external device connection connector	3-18
3.5.3 List of input/output signal details	3-19
3.5.4 Input/output interface internal circuit	3-20

4. INSTALLATION, WIRING AND MAINTENANCE OF THE PRODUCT	4-1 to 4-24
---	--------------------

4.1 Outline of installation, wiring and maintenance	4-2
4.1.1 Installation, wiring and maintenance procedures	4-2
4.1.2 Names of each part	4-3
4.1.3 Handling precautions	4-5
4.2 Installation	4-7
4.2.1 Precautions for installation	4-7
4.3 Wiring	4-8
4.3.1 Precautions for wiring	4-8
4.3.2 Wiring the external device connection connector pins	4-13
4.3.3 Connecting the connector	4-17
4.4 Confirming the installation and wiring	4-18
4.4.1 Items to confirm when installation and wiring are completed	4-18
4.4.2 Single module test	4-19
4.5 Maintenance	4-23
4.5.1 Precautions for maintenance	4-23
4.5.2 Disposal instructions	4-23

5. DATA USED FOR POSITIONING CONTROL (List of buffer memory addresses)	5-1 to 5-124
---	---------------------

5.1 Types of data	5-2
5.1.1 Parameters and data required for control	5-2
5.1.2 Setting items for positioning parameters	5-4
5.1.3 Setting items for zero point return parameters	5-6
5.1.4 Setting items for positioning data	5-7
5.1.5 Setting items for start block data	5-9
5.1.6 Setting items for condition data	5-10
5.1.7 Types and roles of monitor data	5-11
5.1.8 Types and roles of control data	5-14
5.2 List of parameters	5-18

5.2.1 Basic parameters 1	5-18
5.2.2 Basic parameters 2	5-24
5.2.3 Detailed parameters 1	5-28
5.2.4 Detailed parameters 2	5-36
5.2.5 Zero point return basic parameters	5-45
5.2.6 Zero point return detailed parameters	5-52
5.3 List of positioning data	5-56
5.4 List of start block data	5-71
5.5 List of condition data	5-77
5.6 List of monitor data	5-82
5.6.1 System monitor data	5-82
5.6.2 Axis monitor data	5-92
5.7 List of control data	5-106
5.7.1 System control data	5-106
5.7.2 Axis control data	5-112

6. SEQUENCE PROGRAM USED FOR POSITIONING CONTROL	6-1 to 6-38
---	--------------------

6.1 Precautions for creating program	6-2
6.2 List of devices used	6-4
6.3 Creating a program	6-8
6.3.1 General configuration of program	6-8
6.3.2 Positioning control operation program	6-9
6.4 Positioning program examples	6-12
6.5 Program details	6-21
6.5.1 Initialization program	6-21
6.5.2 Start details setting program	6-22
6.5.3 Start program	6-23
6.5.4 Continuous operation interrupt program	6-31
6.5.5 Restart program	6-33
6.5.6 Stop program	6-36

7. MEMORY CONFIGURATION AND DATA PROCESS	7-1 to 7-14
---	--------------------

7.1 Configuration and roles of AD75 memory	7-2
7.1.1 Configuration and roles of AD75 memory	7-2
7.1.2 Buffer memory area configuration	7-5
7.2 Data transmission process	7-6

SECTION 2 CONTROL DETAILS AND SETTING

8. ZERO POINT RETURN CONTROL

8-1 to 8-26

8.1 Outline of zero point return control	8-2
8.1.1 Two types of zero point return control	8-2
8.2 Machine zero point return	8-4
8.2.1 Outline of the machine zero point return operation	8-4
8.2.2 Machine zero point return method	8-5
8.2.3 Zero point return method (1): Near-point dog method	8-6
8.2.4 Zero point return method (2): Stopper stop method 1)	8-8
8.2.5 Zero point return method (3): Stopper stop method 2)	8-11
8.2.6 Zero point return method (4): Stopper stop method 3)	8-14
8.2.7 Zero point return method (5): Count method 1)	8-16
8.2.8 Zero point return method (6): Count method 2)	8-18
8.3 High-speed zero point return	8-20
8.3.1 Outline of the high-speed zero point return operation	8-20
8.4 Positioning to the zero point	8-22

9. MAIN POSITIONING CONTROL

9-1 to 9-62

9.1 Outline of main positioning controls.....	9-2
9.1.1 Data required for main positioning control.....	9-3
9.1.2 Operation patterns of main positioning controls.....	9-4
9.1.3 Designating the positioning address.....	9-14
9.1.4 Confirming the current value.....	9-15
9.1.5 Control unit "degree" handling	9-17
9.1.6 Interpolation control.....	9-19
9.2 Setting the positioning data	9-22
9.2.1 Relation between each control and positioning data	9-22
9.2.2 1-axis linear control	9-23
9.2.3 2-axis linear interpolation control	9-25
9.2.4 1-axis fixed-dimension feed control	9-29
9.2.5 2-axis fixed-dimension feed control (interpolation)	9-31
9.2.6 2-axis circular interpolation control with auxiliary point designation	9-33
9.2.7 2-axis circular interpolation control with center point designation	9-39
9.2.8 Speed control	9-46
9.2.9 Speed/position changeover control	9-48
9.2.10 Current value change.....	9-55
9.2.11 JUMP command.....	9-60

10. ADVANCED POSITIONING CONTROL

10-1 to 10-24

10.1 Outline of advanced positioning control	10-2
10.1.1 Data required for advanced positioning control	10-3

10.1.2 "Start block data" and "condition data" configuration.....	10-4
10.2 Advanced positioning control execution procedure	10-6
10.3 Setting the start block data	10-7
10.3.1 Relation between various controls and start block data	10-7
10.3.2 Block start (normal start)	10-8
10.3.3 Condition start	10-10
10.3.4 Wait start.....	10-11
10.3.5 Simultaneous start	10-12
10.3.6 Stop.....	10-13
10.3.7 Repeated start (FOR loop)	10-14
10.3.8 Repeated start (FOR condition)	10-15
10.3.9 Restrictions when using the NEXT start.....	10-16
10.4 Setting the condition data	10-17
10.4.1 Relation between various controls and the condition data	10-17
10.4.2 Condition data setting examples	10-19
10.5 Start program for advanced positioning control	10-20
10.5.1 Starting advanced positioning control	10-20
10.5.2 Example of a start program for advanced positioning control	10-21

11. MANUAL CONTROL	11-1 to 11-26
---------------------------	----------------------

11.1 Outline of manual control	11-2
11.1.1 Two manual control methods.....	11-2
11.2 JOG operation.....	11-4
11.2.1 Outline of JOG operation	11-4
11.2.2 JOG operation execution procedure	11-7
11.2.3 Setting the required parameters for JOG operation.....	11-8
11.2.4 Creating start programs for JOG operation.....	11-10
11.2.5 JOG operation example	11-13
11.3 Manual pulse generator operation.....	11-17
11.3.1 Outline of manual pulse generator operation.....	11-17
11.3.2 Manual pulse generator operation execution procedure	11-21
11.3.3 Setting the required parameters for manual pulse generator operation	11-22
11.3.4 Creating a program to enable/disable the manual pulse generator operation.....	11-23

12. CONTROL AUXILIARY FUNCTIONS	12-1 to 12-86
--	----------------------

12.1 Outline of auxiliary functions.....	12-2
12.1.1 Outline of auxiliary functions	12-2
12.2 Auxiliary functions specifically for machine zero point returns	12-4
12.2.1 Zero point return retry function	12-4
12.2.2 Zero point shift function	12-8
12.3 Functions for compensating the control	12-11
12.3.1 Backlash compensation function.....	12-11
12.3.2 Electronic gear function	12-13
12.3.3 Near pass mode function.....	12-18

12.4 Functions to limit the control	12-22
12.4.1 Speed limit function	12-22
12.4.2 Torque limit function	12-24
12.4.3 Software stroke limit function	12-27
12.4.4 Hardware stroke limit function	12-33
12.5 Functions to change the control details	12-35
12.5.1 Speed change function	12-35
12.5.2 Override function	12-42
12.5.3 Acceleration/deceleration time change function	12-45
12.5.4 Torque change function	12-48
12.6 Other functions	12-50
12.6.1 Step function	12-50
12.6.2 Skip function	12-55
12.6.3 M code output function	12-58
12.6.4 Teaching function	12-62
12.6.5 Command in-position function	12-72
12.6.6 Stepping motor mode function	12-75
12.6.7 Acceleration/deceleration processing function	12-78
12.6.8 Indirectly specification function	12-82

13. COMMON FUNCTIONS	13-1 to 13-12
-----------------------------	----------------------

13.1 Outline of common functions	13-2
13.2 Parameter initialization function	13-3
13.3 Execution data backup function	13-5
13.4 LED display function	13-7
13.5 Clock data function	13-11

14. TROUBLESHOOTING	14-1 to 14-36
----------------------------	----------------------

14.1 Error and warning details	14-2
14.2 List of errors	14-6
14.3 List of warnings	14-30
14.4 Start during error history	14-36

APPENDICES	Appendix-1 to Appendix-58
-------------------	----------------------------------

Appendix 1 External dimension drawing	Appendix-2
Appendix 2 Format sheets	Appendix-4
Appendix 2.1 Positioning module operation chart	Appendix-4
Appendix 2.2 Parameter setting value entry table	Appendix-6
Appendix 2.3 Positioning data setting value entry table	Appendix-12
Appendix 3 Positioning data (No. 1 to 100), List of buffer memory addresses	Appendix-13
Appendix 4 Connection examples with servo amplifiers manufactured by MITSUBISHI Electric Corporation	Appendix-16
Appendix 4.1 Connection example of A1SD75/AD75 and MR-H□A (Differential driver (Open collector))	Appendix-16
Appendix 4.2 Connection example of A1SD75/AD75 and MR-J2/J2S-□A (Differential driver (Open collector))	Appendix-17

Appendix 4.3 Connection example of A1SD75/AD75 and MR-C□A (Differential driver (Open collector))	Appendix-18
Appendix 5 Connection examples with stepping motors manufactured by ORIENTALMOTOR Co., Ltd.	Appendix-19
Appendix 5.1 Connection example of A1SD75/AD75 and VEXTA UPD (Open collector).....	Appendix-19
Appendix 6 Connection examples with servo amplifiers manufactured by Matsushita Electric Industrial Co., Ltd.	Appendix-20
Appendix 6.1 Connection example of A1SD75/AD75 and MINAS-A series (Differential driver).....	Appendix-20
Appendix 7 Connection examples with servo amplifiers manufactured by SANYO DENKI Co., Ltd.....	Appendix-21
Appendix 7.1 Connection example of A1SD75/AD75 and PYO series (Differential driver).....	Appendix-21
Appendix 8 Connection examples with servo amplifiers manufactured by YASKAWA Electric Corporation	Appendix-22
Appendix 8.1 Connection example of A1SD75/AD75 and Σ -II series (Differential driver).....	Appendix-22
Appendix 9 Comparisons with conventional positioning modules	Appendix-23
Appendix 9.1 Comparisons with AD71 (S1), AD71S2 (A1SD71S2) models	Appendix-23
Appendix 9.2 Comparisons with A1SD75P1/A1SD75P2/A1SD75P3, and AD75P1/ AD75P2/ AD75P3 models	Appendix-24
Appendix 9.3 Comparisons with old versions of A1SD75P1-S3/A1SD75P2-S3/ A1SD75P3-S3, and AD75P1-S3/AD75P2-S3/AD75P3-S3 models.....	Appendix-25
Appendix 10 MELSEC Explanation of positioning terms	Appendix-26
Appendix 11 Positioning control troubleshooting	Appendix-46
Appendix 12 List of buffer memory addresses	Appendix-52

INDEX	Index-1 to Index-12
-------	---------------------

About Manuals

The following manuals are also related to this product.
In necessary, order them by quoting the details in the tables below.

Related Manuals

Manual Name	Manual Number (Model Code)
AD75P1-S3/P2-S3/P3-S3 Positioning Module User's Manual (Hardware) The AD75P1-S3/P2-S3/P3-S3 positioning module performance specifications, input/output interface, names of each part and startup procedures, etc., are explained. (Enclosed with module)	IB-66733 (13J883)
A1SD75P1-S3/P2-S3/P3-S3 Positioning Module User's Manual (Hardware) The A1SD75P1-S3/P2-S3/P3-S3 positioning module performance specifications, input/output interface, names of each part and startup procedures, etc., are explained. (Enclosed with module)	IB-66732 (13J882)
Positioning module software package type SW11VD-AD75P Operating Manual The methods of creating data (parameters, positioning data, etc.), transmitting the data to the module, monitoring the positioning and testing, etc., using the above software package are explained. (Enclosed with each software package product)	IB-66714 (13J915)
GX Configurator-AP Version 1 Operating Manual The methods of creating data (parameters, positioning data, etc.), transmitting the data to the module, monitoring the positioning and testing, etc., using the above software package are explained. (Enclosed with each software package product)	IB-66900 (13J948)

Conformation to the EMC and Low Voltage Directives

For details on making Mitsubishi PLC conform to the EMC directive and low voltage instruction when installing it in your product, please refer to Chapter 3, "EMC Directive and Low Voltage Instruction" of the using PLC CPU module User's Manual (Hardware).

The CE logo is printed on the rating plate on the main body of the PLC that conforms to the EMC directive and low voltage instruction.

To make this product conform to the EMC directive and low voltage instruction, please refer to section 4.3.1 "Precautions for wiring"

Using This Manual (1)

- The symbols used in this manual are shown below.

<table border="1"><tr><td>Pr.*</td></tr></table>	Pr.*	Symbol indicating positioning parameter and zero point return parameter item.
Pr.*		
<table border="1"><tr><td>Da.*</td></tr></table>	Da.*	Symbol indicating positioning data, start block data and condition data item.
Da.*		
<table border="1"><tr><td>Md.*</td></tr></table>	Md.*	Symbol indicating monitor data item.
Md.*		
<table border="1"><tr><td>Cd.*</td></tr></table>	Cd.*	Symbol indicating control data item.
Cd.*		

(A serial No. is inserted in the * mark.)

- Indication of values in this manual

- The buffer memory address, error code and warning code are indicated in a decimal value.
- The X/Y device is indicated in a hexadecimal value.
- The setting data and monitor data is indicated in a decimal or hexadecimal value. An "H" attached at the end of the value indicates a hexadecimal value.

(Examples)

10	Decimal
10H	Hexadecimal

Using This Manual (2)

■ The methods for reading this manual are shown below.

1) → 2) → 3) → 4) → 5) → Test operation → 6) → Actual operation

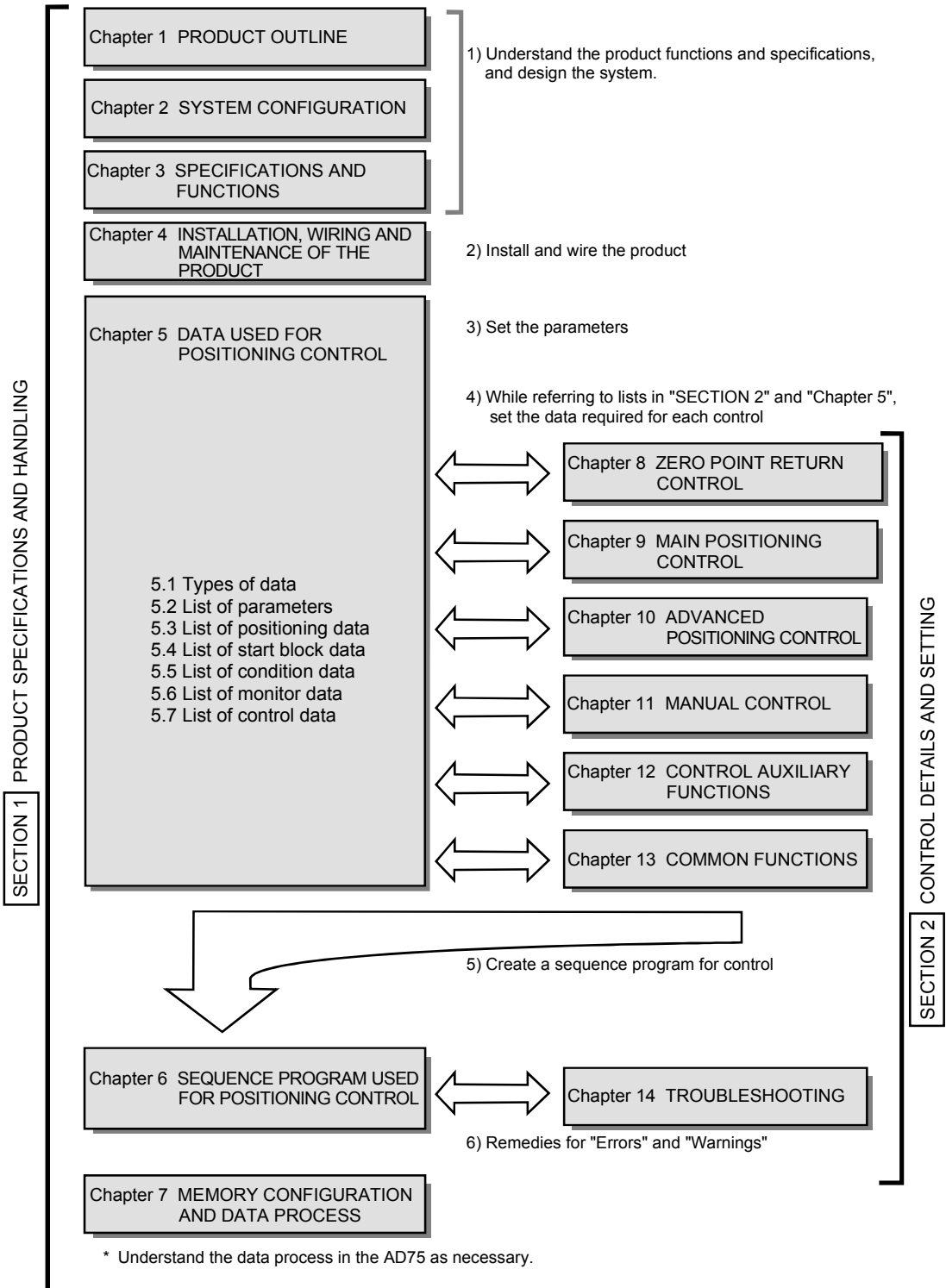

Using This Manual (3)

■ The contents of each chapter are shown below.

SECTION 1 PRODUCT SPECIFICATIONS AND HANDLING

1	PRODUCT OUTLINE	The basic contents for understanding positioning control using AD75 are described.	1	
2	SYSTEM CONFIGURATION	The devices required for positioning control using AD75 are described.	2	
3	SPECIFICATIONS AND FUNCTIONS	The AD75 functions and performance specifications, etc., are described.	3	
4	INSTALLATION, WIRING AND MAINTENANCE OF THE PRODUCT	The procedures for installing and wiring the AD75, the precautions and maintenance are described.	4	
5	DATA USED FOR POSITIONING CONTROL	The setting items, setting details and range, default values, and setting destination buffer memory address for the parameters and data required for positioning control are described.	5	Pr. Da. Md. Cd.
6	SEQUENCE PROGRAM USED FOR POSITIONING CONTROL	The sequence program required for positioning control is described. (Create an actual program using this program as a reference.)	6	
7	MEMORY CONFIGURATION AND DATA PROCESS	The AD75 memory configuration and data process are described. (Read this as required.)	7	

SECTION 2 CONTROL DETAILS AND SETTING

8	ZERO POINT RETURN CONTROL	The details and settings for zero point return control are described.	8
9	MAIN POSITIONING CONTROL	The details and examples of settings for "Main positioning control" using the "Positioning data" are described.	9
10	ADVANCED POSITIONING CONTROL	The details and examples of settings for "Advanced positioning control" using the "Positioning data" are described.	10
11	MANUAL CONTROL	The settings and sequence programs required for JOG operation or manual pulse generator operation are described.	11
12	CONTROL AUXILIARY FUNCTIONS	The settings and sequence programs required for using the auxiliary functions are described.	12
13	COMMON FUNCTIONS	The settings and sequence programs required for using the common functions are described.	13
14	TROUBLESHOOTING	The errors and warnings detected by the AD75 are described.	14
	APPENDICES	Examples of wiring, a glossary and list of buffer memory addresses are described. (Read this as required.)	APPENDICES

Generic Terms and Abbreviations

Unless specially noted, the following generic terms and abbreviations are used in this manual.

Generic term/abbreviation	Details of generic term/abbreviation
PLC CPU	Generic term for PLC CPU on which AD75 can be mounted.
AD75	Generic term for positioning module AD75P1-S3, AD75P2-S3, AD75P3-S3, A1SD75P1-S3, A1SD75P2-S3, and A1SD75P3-S3. The module type is described to indicate a specific module.
Peripheral device	Generic term for DOS/V personal computer that can run the following "AD75 Software Package".
AD75 software package	Generic term for "SW11VD-AD75P type positioning module software package" and "GX Configurator-AP Version 1 (SW0D5C-AD75P-E)."
Drive unit	Abbreviation for pulse input compatible drive unit (servo amplifier, stepping motor).
Manual pulse generator	Abbreviation for manual pulse generator (prepared by user).
Data link system	Abbreviation for MELSECNET (II) and MELSECNET/B data link system.
Network system	Abbreviation for MELSECNET/10 network system.
I/F	Abbreviation for interface.
17-segment LED	17-segment display mounted on upper front of AD75.
DOS/V personal computer	IBM PC/AT [®] and compatible DOS/V compliant personal computer.
Personal computer	Generic term for DOS/V personal computer.
Workpiece	Generic term for moving body such as workpiece and tool, and for various control targets.
Axis 1, axis 2, axis 3	Indicates each axis connected to AD75.
1-axis, 2-axis, 3-axis	Indicates the number of axes. (Example: 2-axis = Indicates two axes such as axis 1 and axis 2, axis 2 and axis 3, and axis 3 and axis 1.)

Enclosed Parts

The AD75 product configuration is shown below.

Part name	Quantity		
	A1SD75P1-S3 AD75P1-S3	A1SD75P2-S3 AD75P2-S3	A1SD75P3-S3 AD75P3-S3
External device connection connector (10136-3000VE, Sumitomo 3M)	1	2	3
Connector cover (10336-56 F0-008, Sumitomo 3M)	1	2	3
AD75	1		
A1SD75P1-S3/P2-S3/P3-S3, AD75P1-S3/P2-S3/P3-S3 Positioning Module User's Manual (Hardware)	1		

MEMO

SECTION 1

PRODUCT SPECIFICATIONS AND HANDLING

SECTION 1 is configured for the following purposes (1) to (5).

- (1) To understand the outline of positioning control, and the AD75 specifications and functions
- (2) To carry out actual work such as installation and wiring
- (3) To set parameters and data required for positioning control
- (4) To create a sequence program required for positioning control
- (5) To understand the memory configuration and data transmission process

Read "SECTION 2" for details on each control.

Chapter 1	PRODUCT OUTLINE	1-1 to 1-18
Chapter 2	SYSTEM CONFIGURATION	2-1 to 2-8
Chapter 3	SPECIFICATIONS AND FUNCTIONS	3-1 to 3-22
Chapter 4	INSTALLATION, WIRING AND MAINTENANCE OF THE PRODUCT	4-1 to 4-24
Chapter 5	DATA USED FOR POSITIONING CONTROL	5-1 to 5-124
Chapter 6	SEQUENCE PROGRAM USED FOR POSITIONING CONTROL.....	6-1 to 6-38
Chapter 7	MEMORY CONFIGURATION AND DATA PROCESS.....	7-1 to 7-14

Chapter 1

PRODUCT OUTLINE

The purpose and outline of positioning control using AD75 are explained in this chapter.

By understanding "What can be done", and "Which procedures to use" beforehand, the positioning system can be structured smoothly.

- 1.1 Positioning control 1-2
 - 1.1.1 Features of AD75..... 1-2
 - 1.1.2 Purpose and applications of positioning control 1-4
 - 1.1.3 Mechanism of positioning control..... 1-6
 - 1.1.4 Outline design of positioning system..... 1-8
 - 1.1.5 Communicating signals between AD75 and each module..... 1-10
- 1.2 Flow of system operation 1-12
 - 1.2.1 Flow of all processes 1-12
 - 1.2.2 Outline of starting 1-14
 - 1.2.3 Outline of stopping 1-16
 - 1.2.4 Outline for restarting 1-17

1.1 Positioning control

1.1.1 Features of AD75

The features of the AD75 are shown below.

(1) Lineup of 1-axis to 3-axis modules

- (a) There are six types of positioning modules for 1-axis to 3-axis control. Select according to the PLC CPU type and the required No. of control axes.
- (b) There is one slot used to mount each AD75 onto the base unit. The number of input/output points occupied by the PLC CPU is 32 points each. There is no limit to the No. of mounted modules as long as the total is within the PLC CPU No. of input/output points.

(2) Ample positioning control functions

- (a) Various functions required for the positioning system, such as positioning control to random position, fixed-dimension feed control and uniform speed control are provided.
 - 1) Up to 600 positioning data items containing the positioning address, control method and operation pattern, etc., can be set for each axis. Positioning for each axis is carried out using this positioning data. (2-axis interpolation control, and multiple axes using simultaneous start is possible.)
 - 2) Linear control (3-axis simultaneous execution possible) is possible with positioning for each axis. This control can carry out independent positioning with one positioning data item, or can carry out continuous positioning with continuous execution of multiple positioning data items.
 - 3) With multiple axes positioning, linear interpolation control or circular interpolation control using two axes is possible. This control can carry out independent positioning with one positioning data item, or can carry out positioning with continuous execution of multiple positioning data items.
- (b) The control method designated with each positioning data includes position control, speed control and speed/position changeover control.
- (c) Continuous positioning with multiple positioning data items is possible with the operation pattern set by the user using positioning data. With the above multiple positioning data as one block, continuous positioning of multiple blocks is possible.

- (d) The zero point return control has been strengthened.
 - 1) The near-point dog method (one type), stopper stop method (three types), and count method (two types) zero point return methods have been prepared as the "machine zero point return" zero point return method.
 - 2) To realize zero point return control to the machine zero point from a random position, the zero point return retry function has been prepared. (The machine zero point is the position used as the start point for control such as positioning control. The machine zero point is established with the machine zero point return in item 1) above.)
 - (e) Automatic trapezoidal acceleration/deceleration and S-curve acceleration/deceleration have been prepared as the acceleration/deceleration methods. The user can select from automatic trapezoidal acceleration/deceleration or S-curve acceleration/deceleration.
- (3) High-speed starting process
- To quicken the process when starting positioning, the start processing time has been reduced to 20ms.
- When operation using simultaneous start function or interpolation operation is executed, no start delay is generated between the target axes.
- (Example) When operation is started with the simultaneous start function for axes 1 and 3: No start delay between axes 1 and 3.
- When interpolation operation is started for axes 2 and axis 3: No start delay between axes 2 and 3.
- (4) High-speed pulse output and long distance with drive unit
- (a) The AD75 has a differential driver and open collector pulse output interface. Connect to either according to the type of drive unit.
 - (b) When connected to the differential driver, the speed and distance have been increased.
 - When connected to differential driver : 400kpps, max. 10m,
 - When connected to open collector : 200kpps, max. 2m
- (5) Easy maintenance
- The maintenance of the AD75 has been improved with the following matters.
- (a) The various data, such as the positioning data and parameters, are stored on a flash ROM in the AD75.
This allows the data to be held without a battery.
 - (b) The error display, machine system input and zero point input state can be confirmed with the 17-segment display.
 - (c) The primary diagnosis has been improved by detailing the error details.
 - (d) Up to 16 history items each for the error and warning information can be held, so the details of the errors and warnings that have occurred can be confirmed easily.

1.1.2 Purpose and applications of positioning control

"Positioning" refers to moving a moving body, such as a workpiece or tool (hereinafter, generically called "workpiece") at a designated speed, and accurately stopping it at the target position. The main application examples are shown below.

■ Punch press (X, Y feed positioning)

- To punch insulation material or leather, etc., as the same shape at a high yield, positioning is carried out with the X axis and Y axis servos.
- After positioning the table with the X axis servo, the press head is positioned with the Y axis servo, and is then punched with the press.
- When the material type or shape changes, the press head die is changed, and the positioning pattern is changed.

■ Palletizer

- Using the servo for one axis, the palletizer is positioned at a high accuracy.
- The amount to lower the palletizer according to the material thickness is saved.

■ Compact machining center (ATC magazine positioning)

Rotation direction for calling 11, 12, 1, 2 or 3

Rotation direction for calling 17 to 20, 1 to 5

Rotation direction for calling 5, 6, 7, 8, 9 or 10

Rotation direction for calling 7 to 16

Current value retrieval position

Current value retrieval position

<No. of tools: 12> <No. of tools: 20>

- The ATC tool magazine for a compact machining center is positioned.
- The relation of the magazine's current value and target value is calculated, and positioning is carried out with forward run or reverse run to achieve the shortest access time.

■ Lifter (Storage of Braun tubes onto aging rack)

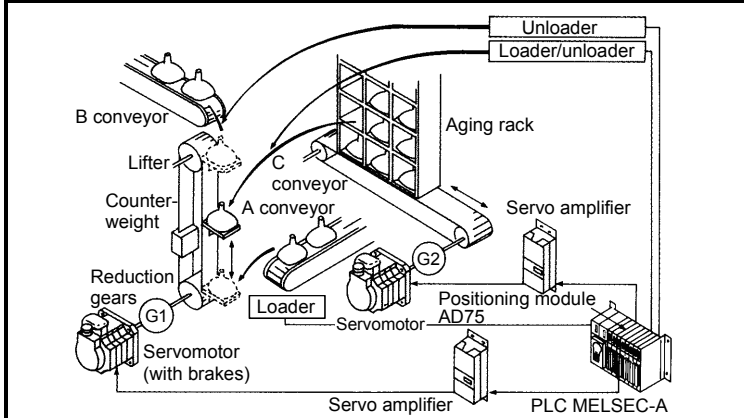

- During the aging process of braun tubes, storage onto the rack is carried out by positioning with the servo.
- The up/down positioning of the lifter is carried out with the 1-axis servo, and the horizontal position of the aging rack is positioned with the 2-axis servo.

■ Index table (High-accuracy indexing of angle)

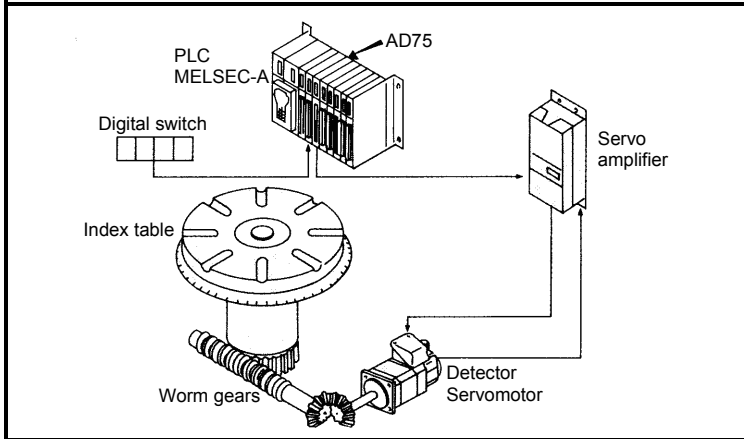

- The index table is positioned at a high accuracy using the 1-axis servo.

■ Inner surface grinder

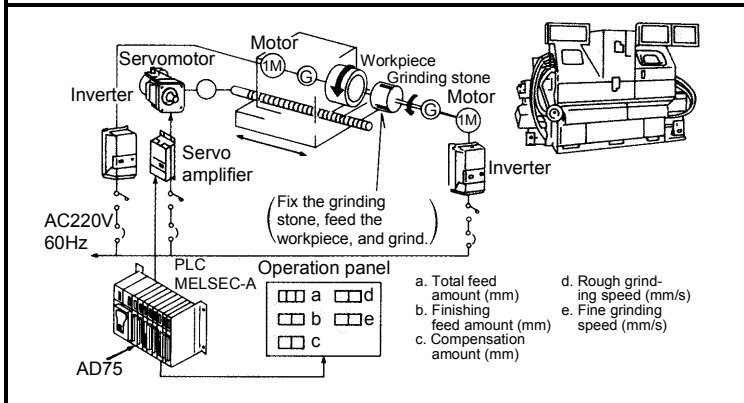

- The grinding of the workpiece's inner surface is controlled with the servo and inverter.
- The rotation of the workpiece is controlled with the 1-axis inverter, and the rotation of the grinding stone is controlled with the 2-axis inverter. The workpiece is fed and ground with the 3-axis servo.

1.1.3 Mechanism of positioning control

Positioning control using the AD75 is carried out with "pulse signals". (The AD75 is a module that generates pulses). In the positioning system using the AD75, various software and devices are used for the following roles. The AD75 realizes complicated positioning control when it reads in various signals, parameters and data and is controlled with the PLC CPU.

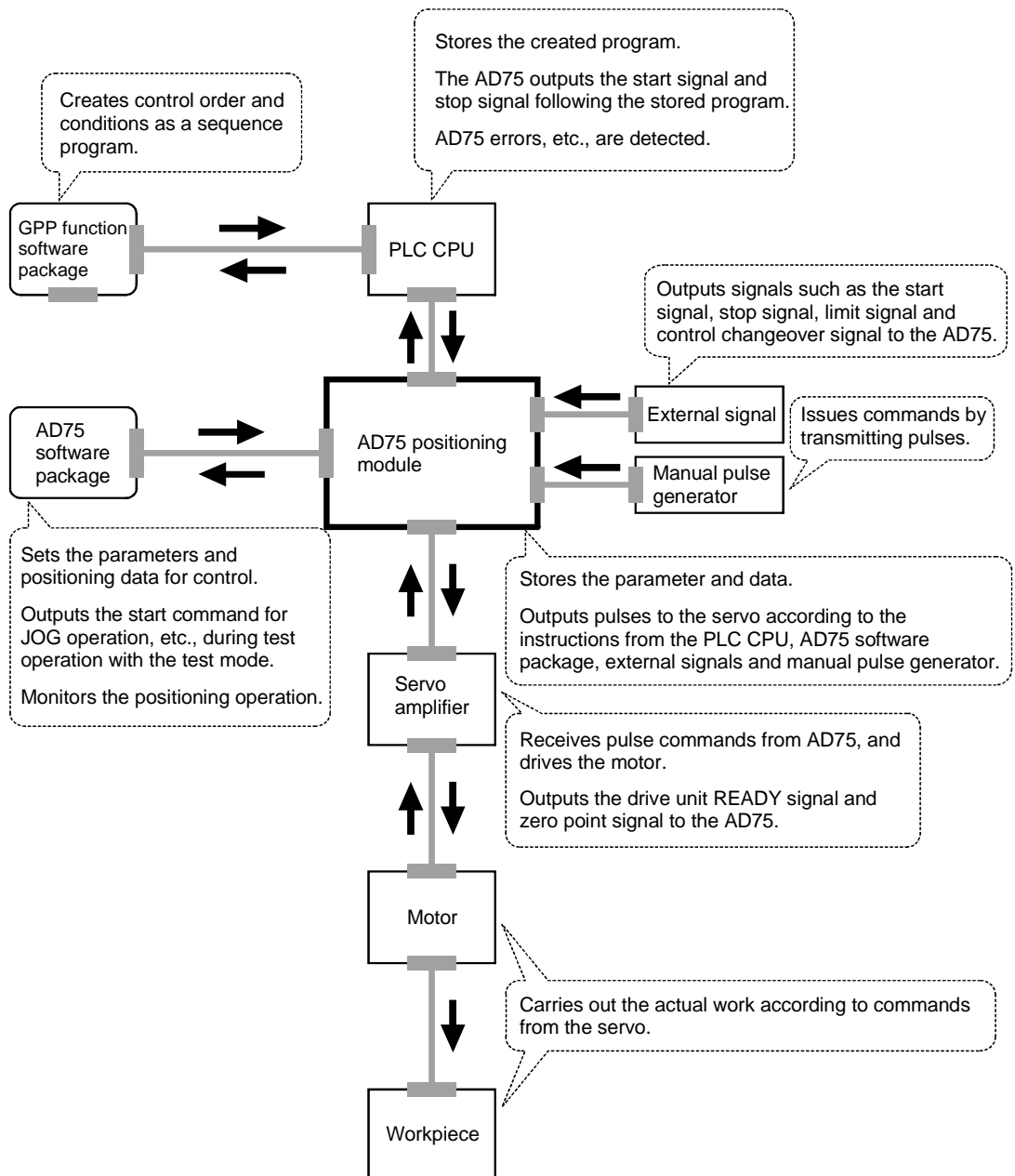

The principle of "position control" and "speed control" operation is shown below.

■ Position control

The total No. of pulses required to move the designated distance is obtained in the following manner.

$$\left[\begin{array}{l} \text{Total No. of pulses} \\ \text{required to move} \\ \text{designated distance} \end{array} \right] = \frac{\left[\text{Designated distance} \right]}{\left[\begin{array}{l} \text{Movement amount of machine (load)} \\ \text{side when motor rotates once} \end{array} \right]} \times \left[\begin{array}{l} \text{No. of pulses required} \\ \text{for motor to rotate once} \end{array} \right]$$

* The No. of pulses required for the motor to rotate once is the "encoder resolution" described in the motor catalog specification list.

When this total No. of pulses is issued from the AD75 to the servo amplifier, control to move the designated distance can be executed.

The machine side movement amount when one pulse is issued to the servo amplifier is called the "movement amount per pulse". This value is the min. value for the workpiece to move, and is also the electrical positioning precision.

■ Speed control

The above "total No. of pulses" is an element required for movement distance control, but when carrying out positioning control or speed control, the speed must also be controlled.

This "speed" is controlled by the "pulse frequency".

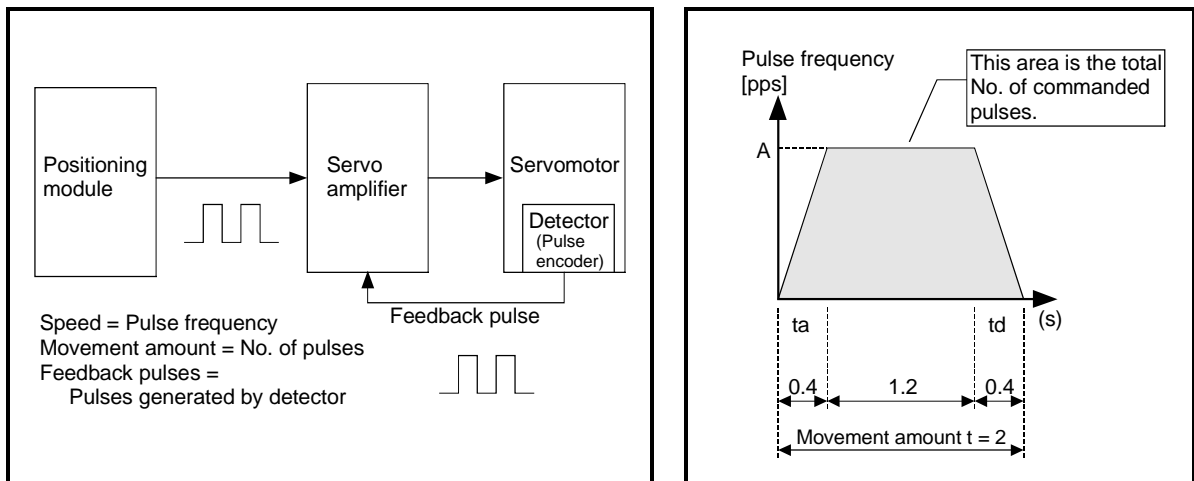

Fig.1.1 Relationship between position control and speed control

POINT

The AD75 controls the position with the "total No. of pulses", and the speed with the "pulse frequency".

1.1.4 Outline design of positioning system

The outline of the positioning system operation and design, using the AD75, is shown below.

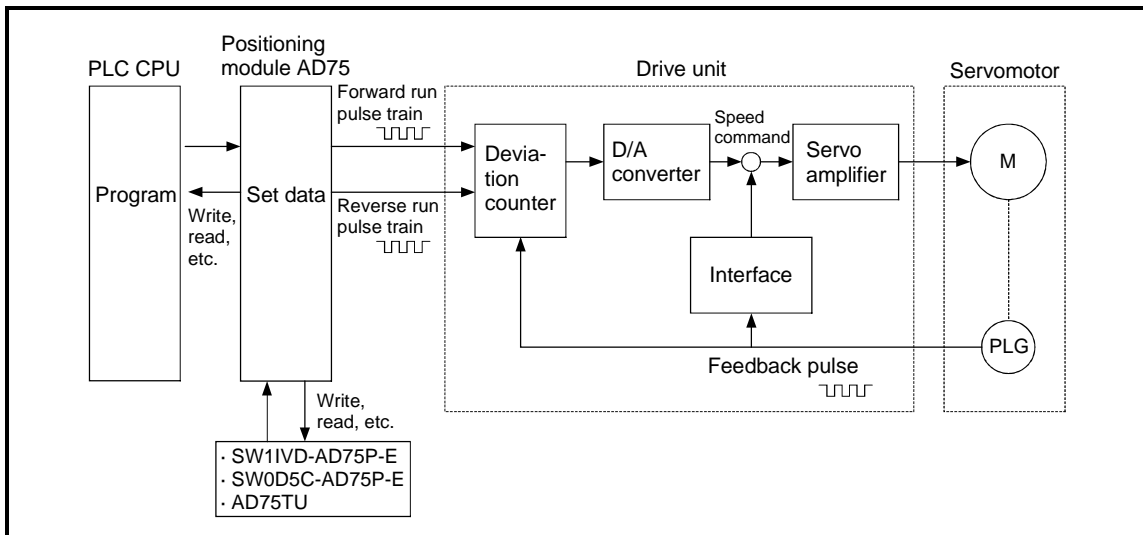

Fig.1.2 Outline of the operation of positioning system using AD75

- 1) The AD75 output is a pulse train.
When the pulse train is output, the pulses are cumulated with the deviation counter. This pulse droop amount is changed into a DC analog voltage by the D/A converter, and is used as the speed command.
- 2) Simultaneously with the start of motor rotation by the speed command from the drive unit, feedback pulses proportional to the speed are generated by the pulse encoder PLG, and the droop pulses in the deviation counter are subtracted. The deviation counter maintains a set droop amount and the motor continues rotating.
- 3) When the command pulse output from the AD75 is stopped, the droop pulses in the deviation counter decreases, and the speed slows. When there are no more droop pulses, the motor stops.
In other words, the motor rotation speed is proportional to the designated pulse frequency, and the motor rotation angle is proportional to the No. of output command pulses.
Thus, if the movement amount per pulse is specified, the motor can be fed to a position proportional to the No. of pulses in the pulse train. The pulse frequency will be the motor speed (feedrate).
- 4) As shown below, the pulse train is rough during motor acceleration, and is dense at the full speed. During deceleration, the pulse train becomes rougher, and finally the pulse reaches 0. The motor stops with a slight delay in respect to the command pulse.
This time difference is required to ensure the stopping precision, and is called the stop settling time.

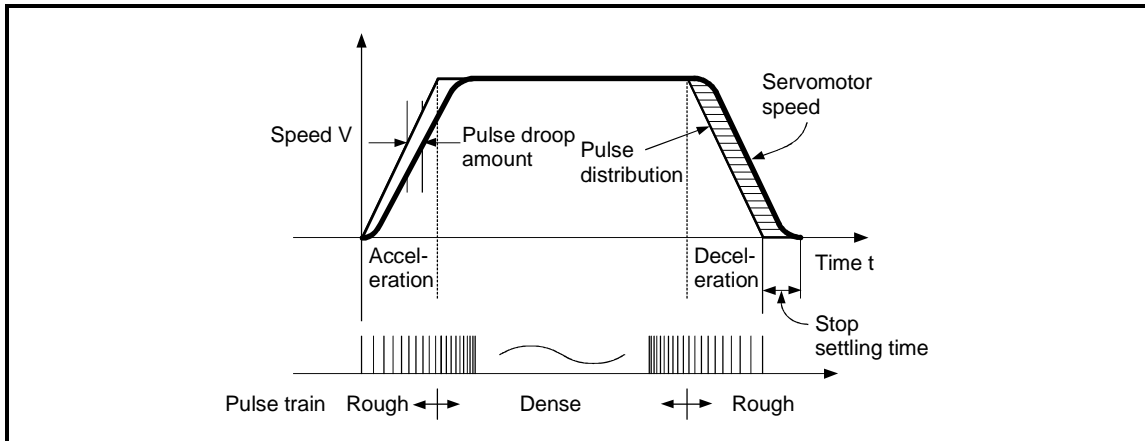

Fig.1.3 AD75 output pulses

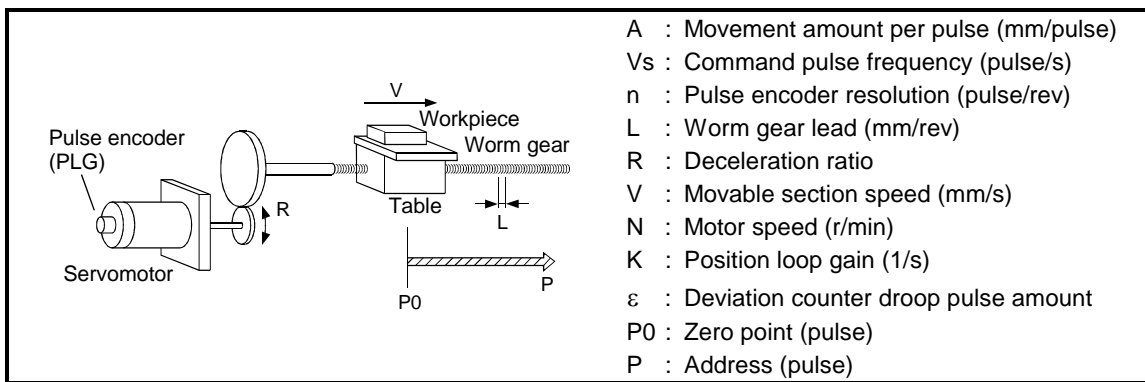

Fig.1.4 System using worm gears

(1) Movement amount per pulse

$$A = \frac{L}{R \times n} \text{ [mm/pulse]}$$

(2) Command pulse frequency

$$Vs = \frac{V}{A} \text{ [pulse /s]}$$

(3) Deviation counter droop pulse amount

$$\varepsilon = \frac{Vs}{K} \text{ [pulse]}$$

The movement amount per pulse is indicated with (1), and the [No. of output pulses] × [movement amount per pulse] is the movement amount. The command pulse frequency is calculated with (2) using the movable section speed and movement amount per pulse. The relation of the command pulse frequency and deviation counter droop pulses is shown in (3).

As the positioning command unit, (mm), (inch), (degree) or (pulse) can be selected independently for the 1 to 3 axes of the AD75.

Thus, if the data such as the movement amount per pulse, acceleration/deceleration time, positioning speed, and positioning address are set to match the positioning command unit, the operation will be carried out within the AD75 for the target positioning address. The pulse train will be output, and positioning will be executed.

1.1.5 Communicating signals between AD75 and each module

The outline of the signal communication between the AD75 and PLC CPU, peripheral device and drive unit, etc., is shown below.

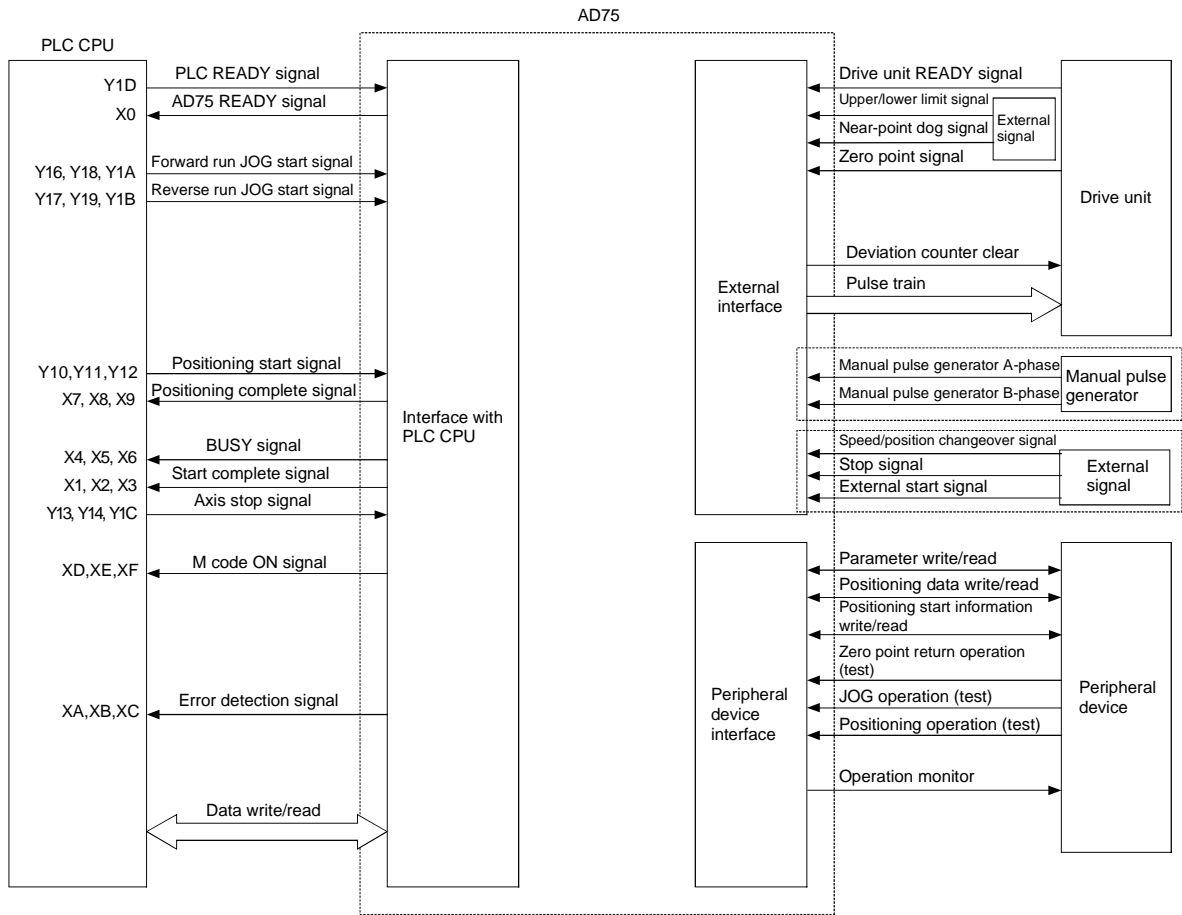

■ AD75 ↔ PLC CPU

The AD75 and PLC CPU communicate the following data via the base unit.

Direction Communication	AD75 → PLC CPU	PLC CPU → AD75
Control signal *	Signal indicating AD75 state, such as AD75 READY signal, BUSY signal.	Signal related to commands such as PLC READY signal, various start signals, stop signals
Data (read/write)	Parameter, positioning data, positioning start information, monitor data, control data	Parameter, positioning data, positioning start information, control data

* Refer to the section "3.4 Specifications of input/output signals with PLC CPU" for details.

■ AD75 ↔ Peripheral device

The AD75 and peripheral device communicate the following data via the peripheral device connection connector.

Direction Communication	AD75 → Peripheral device	Peripheral device → AD75
Data (read/write)	Parameter, positioning data, positioning start information	Parameter, positioning data, positioning start information
Test operation	–	Zero point return control start command Positioning control start command JOG operation start command Manual pulse generator operation enable/disable command
Operation monitor	Monitor data	–

■ AD75 ↔ Drive unit

The AD75 and drive unit communicate the following data via the external device connection connector.

Direction Communication	AD75 → Drive unit	Drive unit → AD75
Control signal	Signals related to commands such as deviation counter clear signal	Signals indicating drive unit state such as drive unit READY signal
Pulse train	Pulse train output	–

■ AD75 ↔ Manual pulse generator

The AD75 and manual pulse generator communicate the following data via the external device connection connector.

Direction Communication	AD75 → Manual pulse generator	Manual pulse generator → AD75
Pulse signal	–	Manual pulse generator A-phase, manual pulse generator B-phase

■ AD75 ↔ External signal

The AD75 and external signal communicate the following data via the external device connection connector.

Direction Communication	AD75 → External signal	External signal → AD75
Control signal	–	<ul style="list-style-type: none"> • Signals from detector such as near-point dog signal, upper/lower limit signal, zero point signal • Control signals from external device such as stop signal, external start signal, speed/position changeover signal

1.2 Flow of system operation

1.2.1 Flow of all processes

The positioning control processes, using the AD75, are shown below.

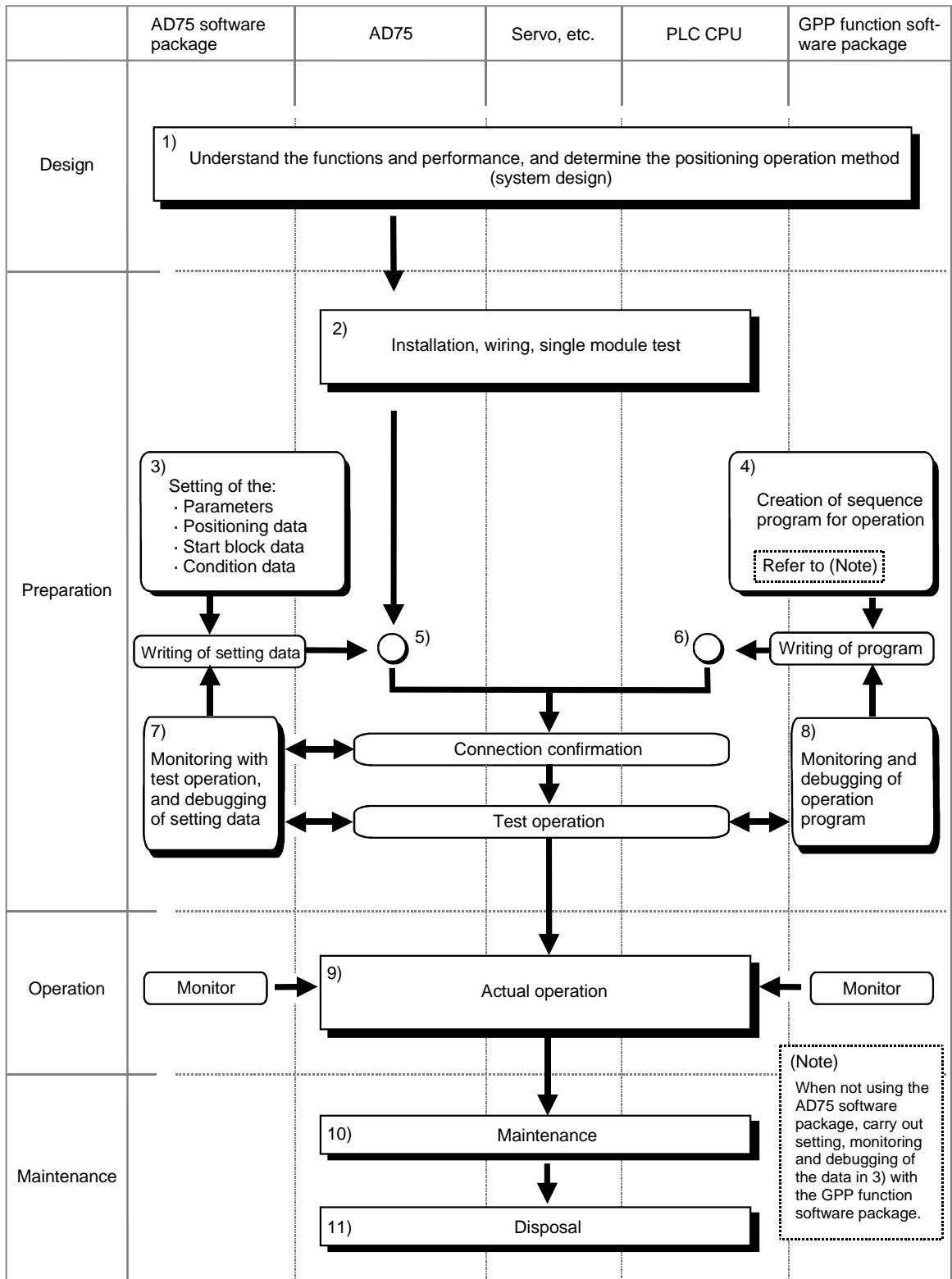

The following work is carried out with the processes shown on the left page.

	Details	Reference
1)	Understand the product functions and usage methods, the configuration devices and specifications required for positioning control, and design the system.	<ul style="list-style-type: none"> • Chapter 1 • Chapter 2 • Chapter 3 • Chapter 8 to Chapter 13
2)	Install the AD75 onto the base unit, wire the AD75 and external connection devices (drive unit, etc.), and connect the AD75 and peripheral devices. Check that the AD75 operates correctly. (Single module test)	<ul style="list-style-type: none"> • Chapter 4
3)	Using the AD75 software package, set the parameters, positioning data, start block data and condition data required for the positioning control to be executed.	<ul style="list-style-type: none"> • Chapter 5 • Chapter 8 to Chapter 13 • AD75 Software Package Operating Manual
4)	Using the GPP function software package, create the sequence program required for positioning operation. (When not using the AD75 software package, also create the sequence program for setting data.)	<ul style="list-style-type: none"> • Chapter 6 • GPP Function Software Package Operating Manual
5)	Write the parameters and positioning data, etc., created with the AD75 software package into the AD75.	<ul style="list-style-type: none"> • Chapter 7 • AD75 Software Package Operating Manual
6)	Using the GPP function software package, write the created sequence program into the PLC CPU. (When not using the AD75 software package, also write in the sequence program for setting data.)	<ul style="list-style-type: none"> • Chapter 7 • GPP Function Software Package Operating Manual
7)	Carry out test operation and adjustments in the test mode to check the connection with the AD75 and external connection device, and to confirm that the designated positioning operation is executed correctly. (Debug the set "parameters" and "positioning data", etc.)	<ul style="list-style-type: none"> • AD75 Software Package Operating Manual
8)	Carry out test operation and adjustment to confirm that the designated positioning operation is executed correctly. (Debug the created sequence program. When not using the AD75 software package, also debug the set data.)	<ul style="list-style-type: none"> • GPP Function Software Package Operating Manual
9)	Actually operate the positioning operation. At this time, monitor the operation state as required. If an error or warning occurs, remedy.	<ul style="list-style-type: none"> • Chapter 5 • Chapter 14 • AD75 Software Package Operating Manual • GPP Function Software Package Operating Manual
10)	Service the AD75 as required.	<ul style="list-style-type: none"> • Chapter 4
11)	Dispose of the AD75.	<ul style="list-style-type: none"> • Chapter 4

1.2.2 Outline of starting

The outline for starting each control is shown with the following flowchart.

* It is assumed that each module is installed, and the required system configuration, etc., has been prepared.

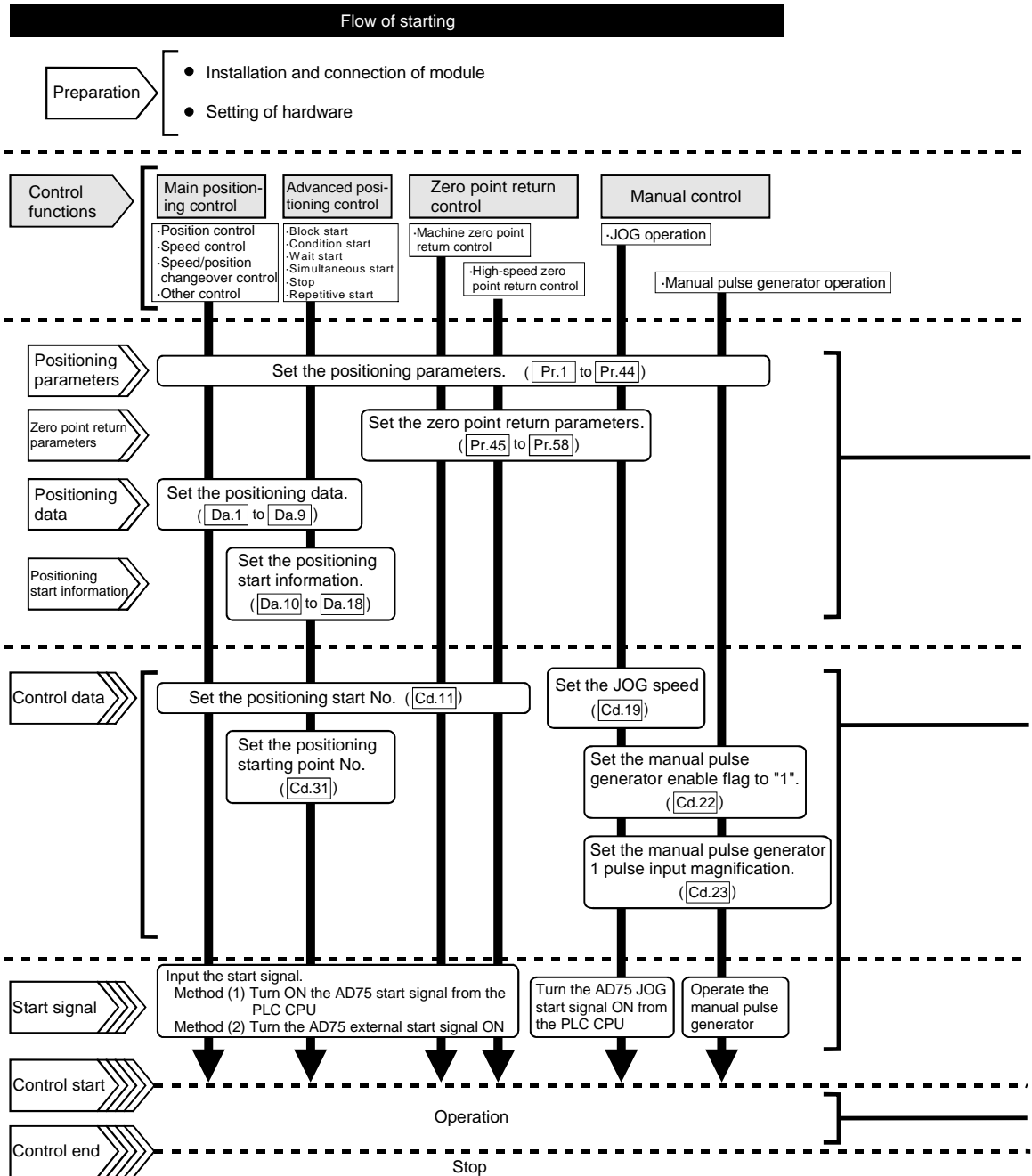

Setting method

▭ : Indicates the sequence program that must be created.

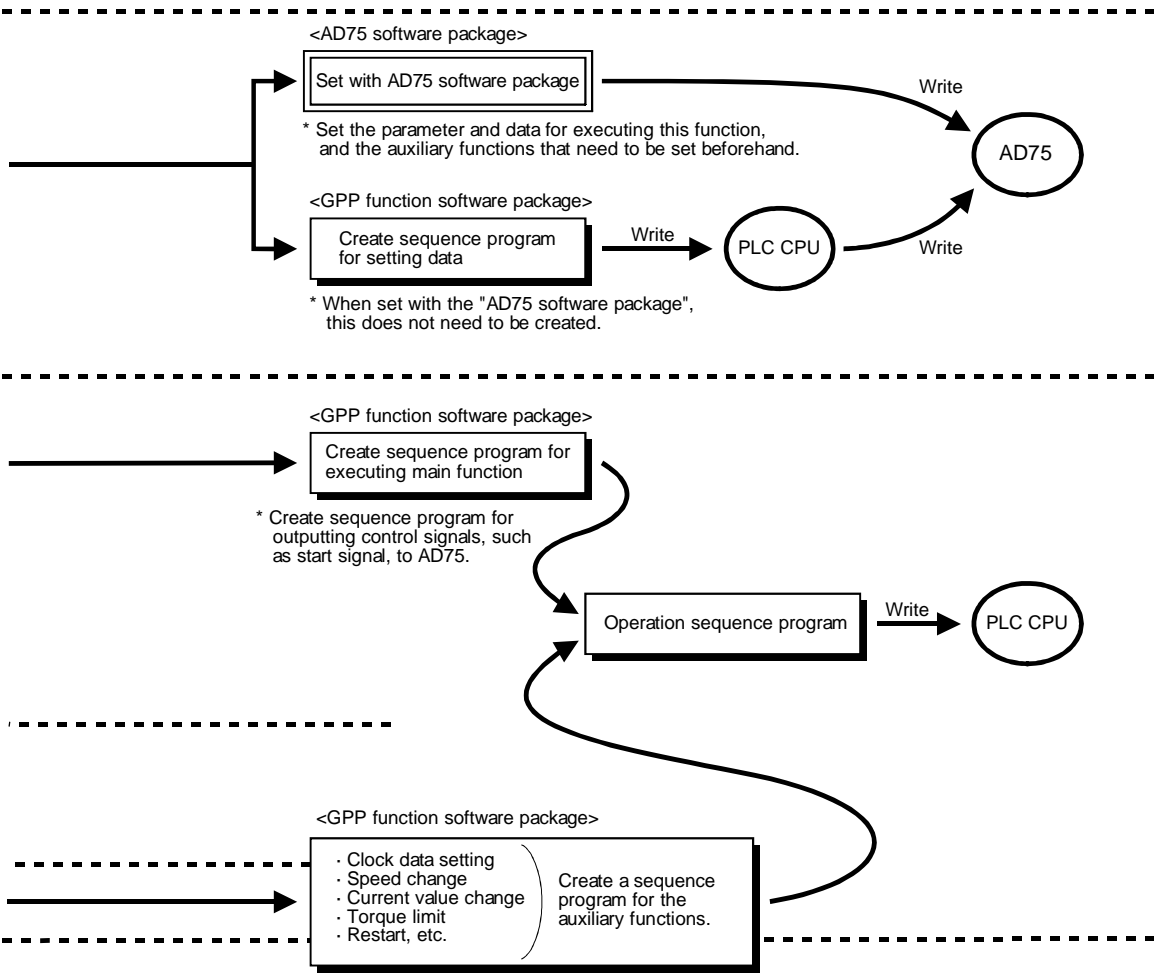

1.2.3 Outline of stopping

Each control is stopped in the following cases.

- (1) When each control is completed normally.
- (2) When the drive unit READY signal is turned OFF.
- (3) When the PLC READY signal is turned OFF (When "parameter error" or "watch dog timer error" occurs in PLC CPU.)
- (4) When an error occurs.
- (5) When control is intentionally stopped (Stop signal from PLC CPU turned ON, stop from peripheral device, etc.)

The outline for the stopping process in these cases is shown below. (Excluding (1) for normal stopping.)

Stop cause		Stop axis	Axis operation status after stopping (Md.35)	Stop process					
				Zero point return control		Main positioning control	Advanced positioning control	Manual control	
				Machine zero point return control	High-speed zero point return control			JOG operation	Manual pulse generator operation
Forced stop	Drive unit READY signal OFF	Each axis	During error	Immediate stop				Immediate stop	
Fatal stop (Stop group 1)	Hardware stroke limit upper/lower limit error occurrence	Each axis	During error	Deceleration stop/sudden stop (Select with Pr.38)				Deceleration stop	
Emergency stop (Stop group 2)	Software stroke limit upper/lower limit error occurrence	Each axis	During error	Deceleration stop/sudden stop (Select with Pr.39)				Deceleration stop	
	PLC READY signal OFF	All axes							
Relatively safe stop (Stop group 3)	Axis error detection (Error other than stop group 1 or 2)	Each axis	During error	Deceleration stop/sudden stop (Select with Pr.40)				Deceleration stop	
	Error in test mode								
Intentional stop (Stop group 3)	"Stop signal" ON from external source	Each axis	When stopped (While waiting)						
	"Axis stop signal" ON from PLC CPU								

1.2.4 Outline for restarting

When a stop cause has occurred during operation with position control causing the axis to stop, positioning to the end point of the positioning data can be restarted from the stopped position by using the "Cd.13 Restart command".

■ When "Cd.13 Restart command" is ON

- (1) If the "Md.35 Axis operation status" is stopped, positioning to the end point of the positioning data will be restarted from the stopped position regardless of the absolute method or incremental method.
- (2) When "Md.35 Axis operation status" is not stopped, the warning "restart not possible" (warning code: 104) will be applied, and the restart command will be ignored.

[Example for incremental method]

The restart operation when the axis 1 movement amount is 300, and the axis 2 movement amount is 600 is shown below.

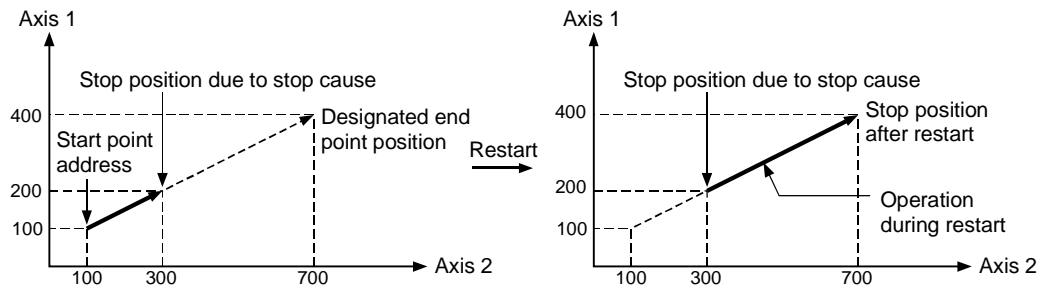

■ Reference

If the positioning start signal [Y10 to Y12]/external start signal is turned ON while the "Md.35 Axis operation status" is waiting or stopped, positioning will be restarted from the start of the positioning start data regardless of the absolute method or incremental method.
(Same as normal positioning.)

[Example for incremental method]

The positioning start operation when the axis 1 movement amount is 300 and the axis 2 movement amount is 600 is shown below.

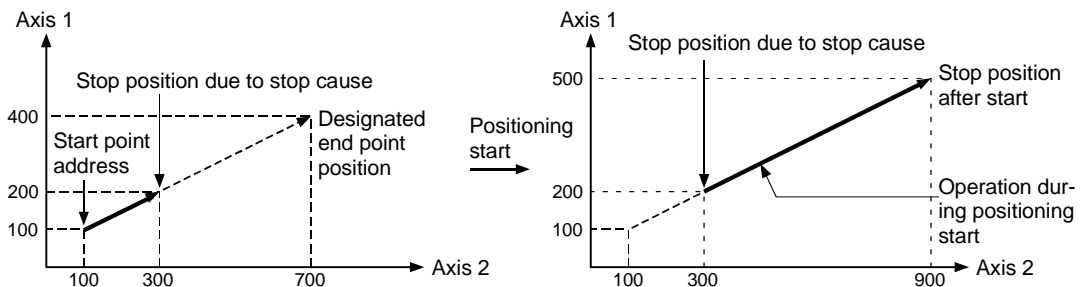

Chapter 2

SYSTEM CONFIGURATION

In this chapter, the general image of the system configuration of the positioning control using AD75, the configuration devices, applicable CPU module and the precautions of configuring the system are explained.
Prepare the required configuration devices to match the positioning control system.

2.1	General image of system	2-2
2.2	List of configuration devices	2-4
2.3	Applicable system.....	2-5
2.4	Precautions for configuring system.....	2-6

2.1 General image of system

The general image of the system, including the AD75, PLC CPU and peripheral devices is shown below.

(The Nos. in the illustration refer to the "No." in section "2.2 List of configuration devices".

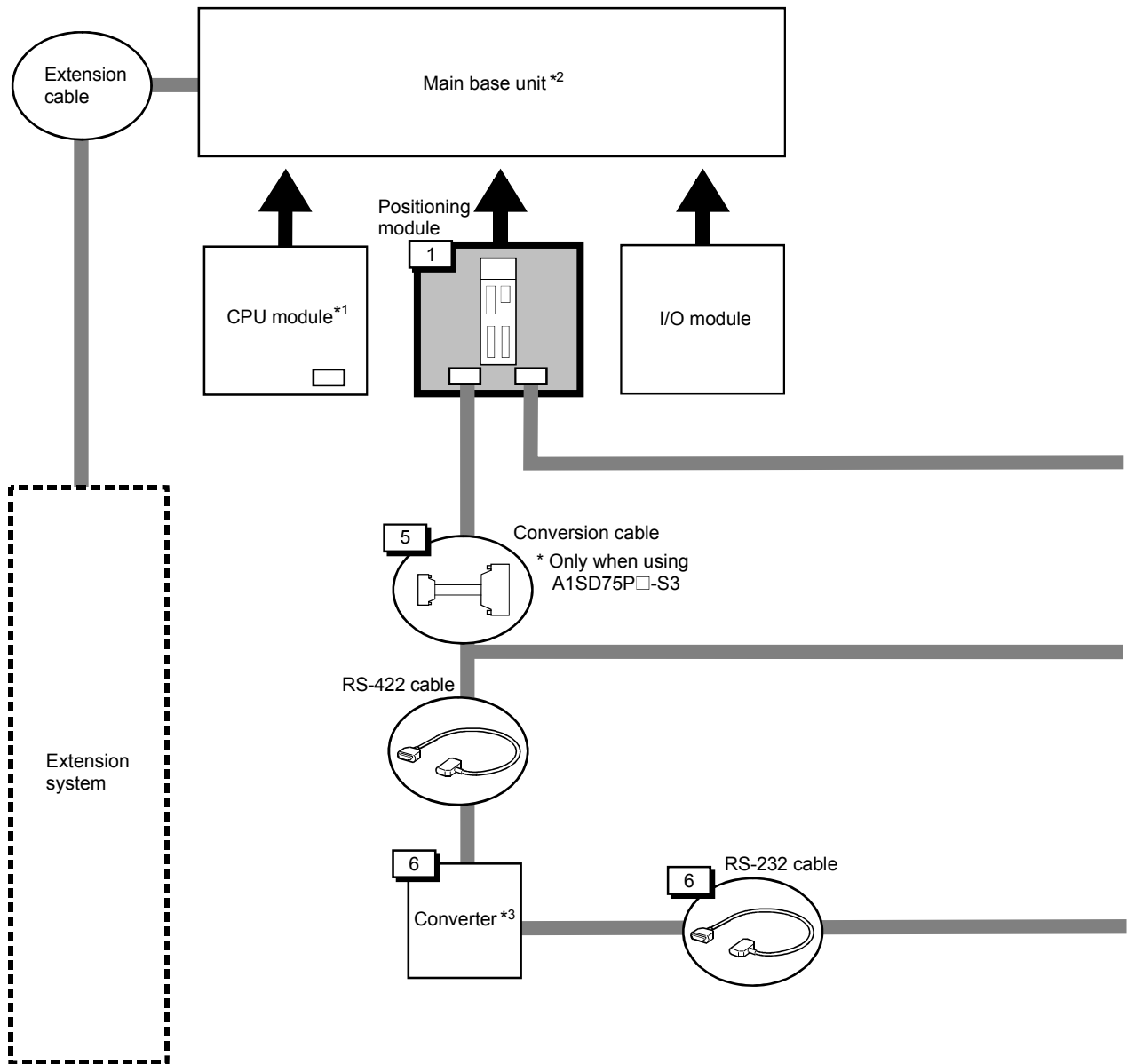

REMARK

- *1 Refer to section "2.3 Applicable system" for the CPU modules that can be used.
- *2 Refer to the CPU module User's Manual for the base units that can be used.
- *3 Refer to the AD75 Software Package Operating Manual.

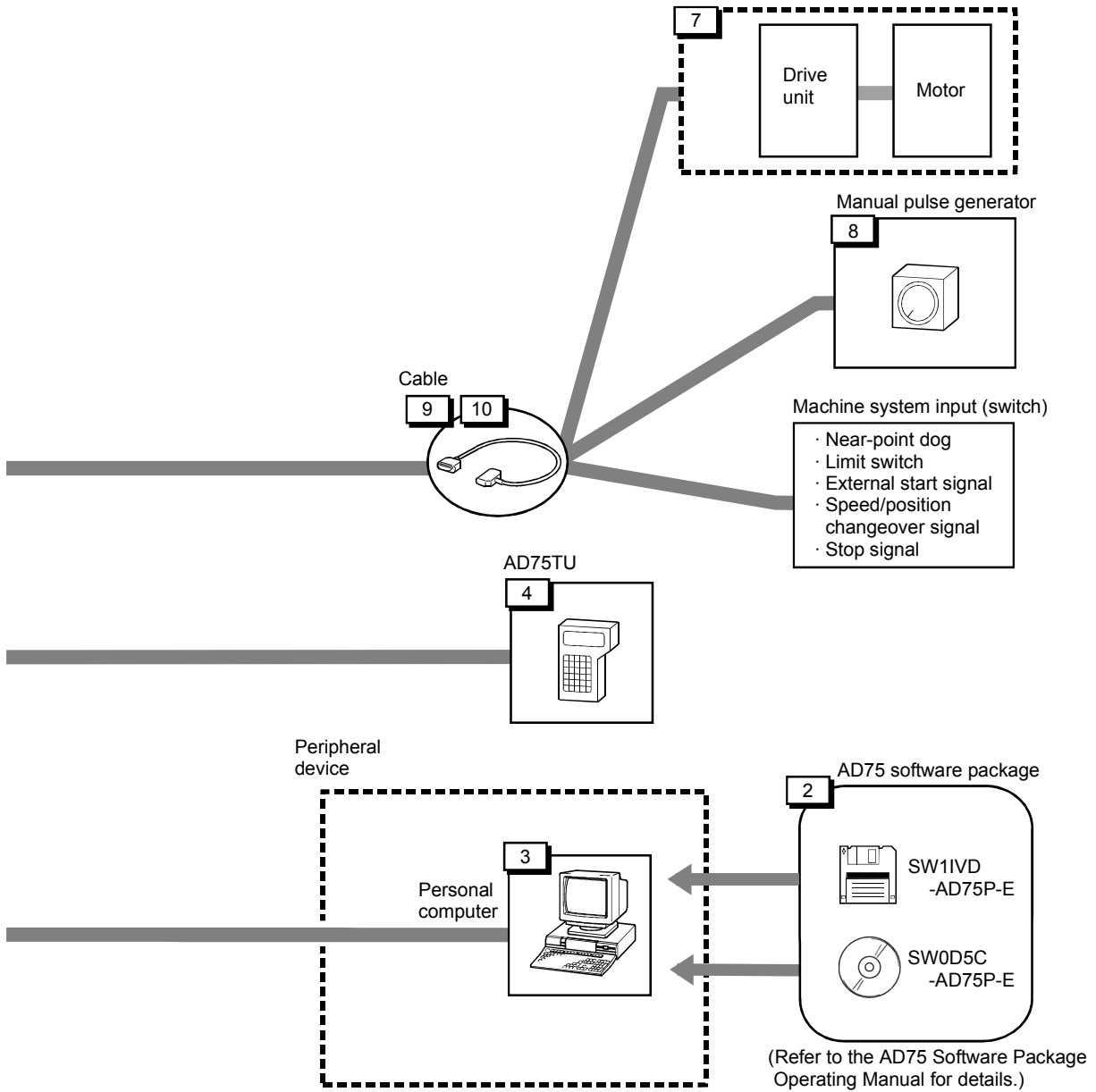

2.2 List of configuration devices

The positioning system using the AD75 is configured of the following devices.

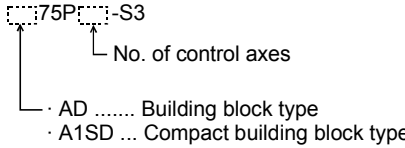
No.	Part name	Type	Remarks	
1	Positioning module	AD75P1-S3 AD75P2-S3 AD75P3-S3 A1SD75P1-S3 A1SD75P2-S3 A1SD75P3-S3		
2	AD75 software package	SW11VD-AD75P-E SW0D5C-AD75P-E	DOS/V personal computer software package For details, refer to the GX Configurator-AP Operating Manual.	
3	Personal computer	DOS/V personal computer	(Prepared by user) Refer to the AD75 Software Package Operating Manual for details.	
4	Teaching unit	AD75TU	Unit for setting, monitoring and testing the AD75 parameters and positioning data.	
5	Conversion cable	A1SD75-C01H A1SD75-C01HA	Length 30cm	Cable for connecting RS-422 cable and A1SD75P□-S3.
6	Connection cable (converter)	—	RS-232 cable for connecting AD75 with DOS/V personal computer, and RS-232/RS-422 converter. (Prepared by user) Refer to the AD75 Software Package Operating Manual for details.	
7	Drive unit	—	(Prepared by user)	
8	Manual pulse generator	—	(Prepared by user) Recommended: MR-HDP01 (Mitsubishi Electric)	
9	Connection cable (dedicated)	AD75C20SH	For MR-H	Cable for connecting AD75 with drive unit, manual pulse generator or machine system input signal.
		AD75C20SJ2	For MR-J2/J2S-A	
		AD75C20SC	For MR-C	
10	Connection cable (prepared by user)	—	Cable for connecting AD75 with drive unit, manual pulse generator or machine system input signal. (Prepared by user) Refer to manual of connected device.	

■ Specifications list of recommended manual pulse generator

Item	Specifications
Module name	MR-HDP01
Pulse resolution	25 pulse/rev (100 pulse/rev after magnification by 4)
Output method	Voltage-output (power supply voltage -1V or more), Output current = Max. 20mA
Power supply voltage	4.5 to 13.2VDC
Current consumption	60mA
Life time	100 revolutions (at 200r/min)
Permitted axial loads	Radial load : Max. 19.6N
	Thrust load : Max. 9.8N
Operation temperature	-10 to 60°C (14 to 140°F)
Weight	0.4 (0.88) [kg(lb)]
Number of max. revolution	Instantaneous Max. 600r/min. normal 200r/min
Pulse signal status	2 signals : A phase, B phase, 90° phase difference
Friction torque	0.1N/m (at 20°C (68°F))

2.3 Applicable system

The CPU module and remote I/O station applicable for the AD75 are shown below.

■ CPU module

PLC CPU *1 \ AD75	For AD75P1-S3/AD75P2-S3/AD75P3-S3	For A1SD75P1-S3/A1SD75P2-S3/A1SD75P3-S3	
ACPU	<ul style="list-style-type: none"> • A0J2CPU • A0J2HCPU • A1CPU • A2CPU (-S1) • A3CPU • A1NCP • A2NCP (-S1) • A3NCP • A3MCP • A3HCP • A2ACP (-S1) • A3ACP 	<ul style="list-style-type: none"> • A2UCPU (-S1) • A3UCPU • A4UCPU • A73CPU (-S3) *2 • A81CPU • A52GCP • A1SCP • A1SJCP-S3 • A2SCP • A2ASCP (-S1) • A1SHCP • A2SHCP • A1SJHCP • A2USHCP-S1 	<ul style="list-style-type: none"> • A1SCP • A1SJCP (-S3) • A2SCP • A2ASCP (-S1) • A52GCP • A1SHCP • A2SHCP • A1SJHCP
QnACPU	<ul style="list-style-type: none"> • Q2ACP (-S1) • Q2ASCP (-S1) • Q2ASHCP (-S1) 	<ul style="list-style-type: none"> • Q3ACP • Q4ACP • Q4ARCP 	<ul style="list-style-type: none"> • Q2ASCP (-S1) • Q2ASHCP (-S1)
QCPU (A mode)	-		<ul style="list-style-type: none"> Q02CP-A Q02HCP-A Q06HCP-A

*1 Including PLC CPU with link function.

*2 When using the A73CPU(-S3), mount the AD75P1-S3, AD75P2-S3 or AD75P3-S3 on the extension base unit.

■ Remote I/O station (MELSECNET/10, MELSECNET (II), MELSECNET/B)

The AD75P1-S3/AD75P2-S3/AD75P3-S3 and A1SD75P1-S3/A1SD75P2-S3/A1SD75P3-S3 positioning modules are applicable for the data link system (MELSECNET (II)/B) and network system (MELSECNET/10) remote I/O station, with the exception of A0J2P25/R25 (remote I/O station).

2.4 Precautions for configuring system

The following precautions apply when configuring the positioning system using the AD75.

- Precautions for mounting base unit
- Precautions according to module version
- Precautions for using stepping motor
- Precautions for using 3-axis module

■ Precautions for mounting base unit

The AD75 can be mounted in a random slot of the main base unit or extension base unit. Note that the following precautions must be observed.

- (1) When mounting the AD75 in an extension base unit that has no power supply, take special care to the power capacity and the voltage drop.
- (2) The AD75P1-S3/AD75P2-S3/AD75P3-S3 cannot be mounted into the final slot at the 7th extension stage of the A3CPU.
- (3) The AD75P1-S3/AD75P2-S3/AD75P3-S3 cannot be mounted into the main base unit of the A73CPU(-S3).
Simultaneous start and interpolation operation with the axis controlled by the A73(S3)CPU/A373CPU PCPU is not possible.
- (4) When mounting onto the PLC CPU or base unit, refer to the User's Manual of the PLC CPU being used.

POINT
One slot is required for mounting the AD75 onto the base unit. The No. of input/output points occupied in respect to the PLC CPU is 32 points. When assigning the I/O with the parameters, set as "special 32 points". There is no limit to the No. of mounted modules as long as the total is within the PLC CPU's No. of input/output points.

■ Precautions according to module version

Some AD75 cannot be used depending on the module version. Refer to "Appendix 9.3 Comparison with old versions of A1SD75P1-S3/A1SD75P2-S3/A1SD75P3-S3, and AD75P1-S3/AD75P2-S3/AD75P3-S3 models" for details.

■ Precautions for using stepping motor

When configuring the positioning system using a stepping motor, the following points must be observed. Refer to section "12.6.6 Stepping motor mode functions" for details.

(1) Setting the stepping motor mode

(a) When using a stepping motor with the AD75, the stepping motor mode must be set.

If the stepping motor mode is not set, the stepping motor cannot be controlled correctly.

(b) When the stepping motor mode is set, there will be limits to the control method and positioning address, etc.

(2) Sharing of bias speed at starting

When using the stepping motor, by selecting the stepping motor mode and setting the bias speed for starting, the motor rotation can be started smoothly.

(3) S-curve acceleration/deceleration use inhibited

S-curve acceleration/deceleration is not possible when using the stepping motor. The motor may step out if used.

(4) Circular interpolation control inhibited

Circular interpolation control cannot be used when using the stepping motor. An "Control method setting error" (error code: 524) will occur if used.

■ Precautions for using 3-axis module

When configuring a positioning system using a 3-axis module (A1SD75P3-S3, AD75P3-S3), the following precautions must be observed.

(1) No. of FROM/TO commands executed in one scan

(Refer to section "6.1 Precautions for creating program" for details.)

The No. of FROM/TO commands (during 16-bit transmission), DFRO/DTO commands (during 32-bit transmission) and special function module device (U□\G□) executed in one scan will be as follows.

- When carrying out circular interpolation control or S-curve acceleration/deceleration: 4 times/axis
- When CHG signal is simultaneously input for two axes with speed/position changeover control: 4 times/axis
- Control other than the above: 10 times/axis

(2) Execution of speed/position changeover control

If there is a timing at which the CHG signal is input simultaneously for 3 axes with the speed/position changeover control, split the AD75. (Example: Split into 1-axis and 2-axis.)

When using the stepping motor, this can cause step out.

Furthermore, machine vibration could occur because of the frequency fluctuation.

Chapter 3

SPECIFICATIONS AND FUNCTIONS

The various specifications of the AD75 are explained in this chapter.

The "General specifications", "Performance specifications", "List of functions", "Specifications of input/output signals with PLC CPU", and the "Specifications of input/output interfaces with external devices", etc., are described as information required when designing the positioning system.

Confirm each specification before designing the positioning system.

3.1	General specifications	3-2
3.2	Performance specifications	3-3
3.3	List of functions	3-4
3.3.1	AD75 control functions.....	3-4
3.3.2	AD75 main functions.....	3-6
3.3.3	AD75 auxiliary functions and common functions.....	3-8
3.3.4	Combination of AD75 main functions and auxiliary functions.....	3-10
3.4	Specifications of input/output signals with PLC CPU.....	3-12
3.4.1	List of input/output signals with PLC CPU	3-12
3.4.2	Details of input signals (AD75 → PLC CPU)	3-13
3.4.3	Details of output signals (PLC CPU → AD75).....	3-15
3.5	Specifications of input/output interfaces with external devices.....	3-16
3.5.1	Electrical specifications of input/output signals.....	3-16
3.5.2	Signal layout for external device connection connector	3-18
3.5.3	List of input/output signal details	3-19
3.5.4	Input/output interface internal circuit	3-20

3.1 General specifications

The general specifications of the AD75 are given below.

Item	Specifications					
Working ambient temperature	0 to 55 °C					
Storage ambient temperature	-20 to 75 °C					
Working ambient humidity	10 to 90% RH, with no dew condensation					
Storage ambient humidity	10 to 90% RH, with no dew condensation					
Vibration resistance	JIS B 3502, IEC 61131-2 compliant		Frequency	Acceleration	Amplitude	10 times each in X, Y and Z directions (During 80 minutes)
		For intermittent vibration	10 to 57Hz	–	0.075mm	
			57 to 150Hz	9.8m/s ²	–	
		For continuous vibration	10 to 57Hz	–	0.035mm	
57 to 150Hz	4.9m/s ²		–			
Impact resistance	JIS B 3502, IEC 61131-2 compliant (147m/s ² , three times each in X, Y and Z directions)					
Working atmosphere	Must be no corrosive gases					
Working altitude * ³	2,000m or less					
Installation place	Within control panel					
Overvoltage category * ¹	II or less					
Degree of contamination * ²	2 or less					

*¹ Indicates to which power distribution section, from the public power distribution network to the in-plant machine device, the device is assumed to be connected to.

Category II applies to a device fed power from a fixed facility.

The withstand surge voltage level for a device with a rating up to 300V is 2500V.

*² Exponential indicating the degree of conductive matter generated in the environment where device is used.

In the degree of contamination level 2, only non-conductive contaminants are generated. However, temporary conductivity could occur due to rare condensation.

*³ Do not use or store the PLC in the environment where the pressure is higher than the atmospheric pressure at sea level. Otherwise, malfunction may result. To use the PLC in high-pressure environment, contact your nearest Mitsubishi representative.

3.2 Performance specifications

Model		A1SD75P1-S3 AD75P1-S3	A1SD75P2-S3 AD75P2-S3	A1SD75P3-S3 AD75P3-S3
Item				
No. of control axes		1 axis	2 axes	3 axes
Interpolation function		None	2-axis linear interpolation 2-axis circular interpolation	2-axis linear interpolation 2-axis circular interpolation
Control method		PTP (Point To Point) control, path control (both linear and arc can be set), speed control, speed/position changeover control		
Control unit		mm, inch, degree, pulse		
Positioning data		Set with peripheral device : 600 data (positioning data No. 1 to 600)/axis setting possible Set with sequence program : 100 data (positioning data No. 1 to 100)/axis setting possible		
Backup		Parameters and positioning data can be saved on flash ROM (battery-less).		
Positioning	Positioning method	PTP control : Incremental method/absolute method Speed/position changeover : Incremental method Path control : Incremental method/absolute method		
	Positioning range *	<div style="border: 1px solid black; padding: 2px;">For absolute method</div> <ul style="list-style-type: none"> • -214748364.8 to 214748364.7 (μm)/-13421772.8 to 13421772.7 (μm) • -21474.83648 to 21474.83647 (inch)/-1342.17728 to 1342.17727 (inch) • 0 to 359.99999 (degree)/0 to 359.99999 (degree) • -2147483648 to 2147483647 (pulse)/-134217728 to 134217727 (pulse) <div style="border: 1px solid black; padding: 2px;">For incremental method</div> <ul style="list-style-type: none"> • -214748364.8 to 214748364.7 (μm)/-13421772.8 to 13421772.7 (μm) • -21474.83648 to 21474.83647 (inch)/-1342.17728 to 1342.17727 (inch) • -21474.83648 to 21474.83647 (degree)/-1342.17728 to 1342.17727 (degree) • -2147483648 to 2147483647 (pulse)/-134217728 to 134217727 (pulse) <div style="border: 1px solid black; padding: 2px;">For speed/position changeover control</div> <ul style="list-style-type: none"> • 0 to 214748364.7 (μm)/0 to 13421772.7 (μm) • 0 to 21474.83647 (inch)/0 to 1342.17727 (inch) • 0 to 21474.83647 (degree)/0 to 1342.17727 (degree) • 0 to 2147483647 (pulse)/0 to 134217727 (pulse) 		
	Speed command *	0.01 to 6000000.00 (mm/min)/0.01 to 375000.00 (mm/min) 0.001 to 600000.000 (inch/min)/0.001 to 37500.000 (inch/min) 0.001 to 600000.000 (degree/min)/0.001 to 37500.000 (degree/min) 1 to 1000000 (pulse/s)/1 to 62500 (pulse/s) Note: Refer to Section "12.3.2 Electronic gear function" [3].		
	Acceleration/deceleration process	Automatic trapezoidal acceleration/deceleration, S-curve acceleration/deceleration		
	Acceleration/deceleration time	Changeover between 1 to 65535 (ms)/1 to 8388608 (ms) possible Four patterns can be set each for acceleration time and deceleration time		
	Sudden stop deceleration time	Changeover between 1 to 65535 (ms)/1 to 8388608 (ms) possible (Same range as acceleration/deceleration time)		
	External device connection connector	10136-3000VE (soldered type, accessory) 10136-6000EL (crimp type, optional)		
Applicable wire size	For 10136-3000VE : AWG#24 to #30 (approx. 0.05 to 0.2 SQ) For 10136-6000EL : AWG#28 (approx. 0.08 SQ)			
Max. output pulse	When connected to differential driver : 400kpps When connected to open collector : 200kpps			
Max. connection distance between servos	When connected to differential driver : 10m When connected to open collector : 2m			
Internal current consumption (5VDC)	A1SD75P□-S3: 0.7A or less, AD75P□-S3: 0.7A or less (However, when the A1SD75P3-S3 or AD75P3-S3 is connected with the differential driver method, the internal current consumption value is 0.78A.)			
Flash ROM write count	Maximum 100,000 times			
No. of occupied input/output points	32 points (I/O assignment: special function module 32 points)			
Outline dimensions	A1SD75P□-S3:130(H) × 34.5(W) × 93.6(D) (mm), AD75P□-S3:250(H) × 37.5(W) × 106(D) (mm)			
Weight	A1SD75P□-S3: 0.35 (kg), AD75P□-S3: 0.45 (kg)			

* Indicates the standard mode/stepping motor mode.

3.3 List of functions

3.3.1 AD75 control functions

The AD75 has several functions. In this manual, the AD75 functions are categorized and explained as follows.

■ Main functions

(1) Zero point return control

"Zero point return control" is a function that established the start point for carrying out positioning control, and carries out positioning toward that start point. This is used to return a workpiece, located at a position other than the zero point when the power is turned ON or after positioning stop, to the zero point. The "zero point return control" is preregistered in the AD75 as the "Positioning start data No. 9001 (Machine zero point return)", and "Positioning start data No. 9002 (High-speed zero point return)". (Refer to "Chapter 8 ZERO POINT RETURN CONTROL".)

(2) Main positioning control

This control is carried out using the "Positioning data" stored in the AD75. Basic control, such as position control and speed control, is executed by setting the required items in this "positioning data" and starting that positioning data. An "operation pattern" can be set in this "positioning data", and with this whether to carry out control with continuous positioning data (ex.: positioning data No. 1, No. 2, No. 3, ...) can be set. (Refer to "Chapter 9 MAIN POSITIONING CONTROL".)

(3) Advanced positioning control

This control executes the "positioning data" stored in the AD75 using the "positioning start information". The following types of applied positioning control can be carried out.

- Random blocks, handling several continuing positioning data items as "blocks", can be executed in the designated order.
- "Condition judgment" can be added to position control and speed control.
- The positioning data having the same No. and set for multiple axes can be started simultaneously. (Pulses are output simultaneously to multiple servos.)
- The designated positioning data can be executed repeatedly, etc., (Refer to "Chapter 10 ADVANCED POSITIONING CONTROL".)

(4) Manual control

By inputting a signal into the AD75 from an external source, the AD75 will output a random pulse train and carry out control. Use this manual control to move the workpiece to a random position (JOG operation), and to finely adjust the positioning (manual pulse generator operation), etc. (Refer to "Chapter 11 MANUAL CONTROL".)

■ Auxiliary functions

When executing the main functions, control compensation, limits and functions can be added. (Refer to "Chapter 12 CONTROL AUXILIARY FUNCTIONS".)

■ Common functions

Common control using the AD75 for "parameter initialization" or "backup of execution data" can be carried out. (Refer to "Chapter 13 COMMON FUNCTIONS".)

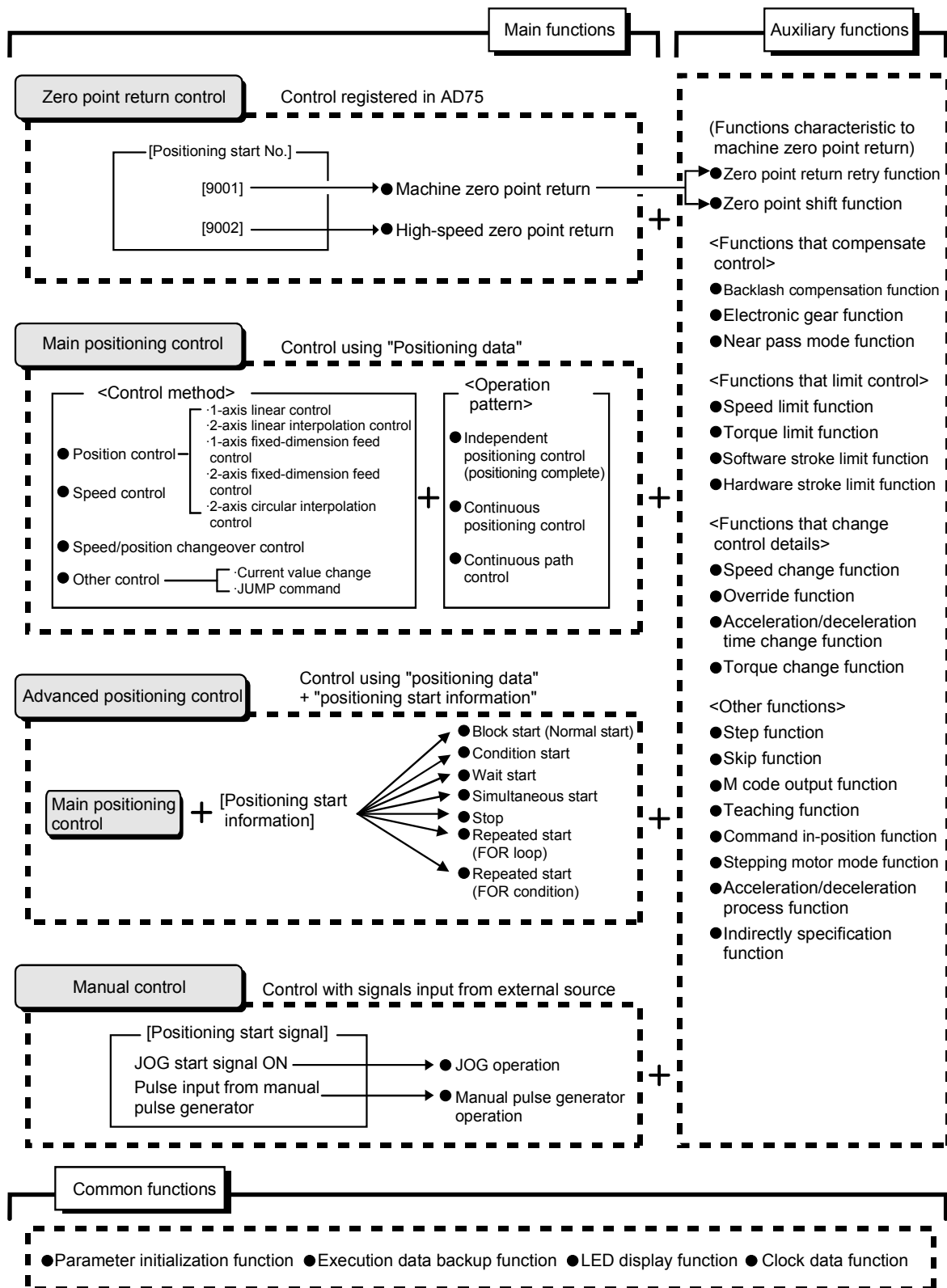

3.3.2 AD75 main functions

The outline of the main functions for positioning control with the AD75 are described below. (Refer to "SECTION 2" for details on each function.)

Main functions		Details	Reference section	
Zero point return control	Machine zero point return control	Mechanically establishes the positioning start point with a near-point dog or stopper. (Positioning start No.9001)	8.2	
	High-speed zero point return control	Positions to the zero point address (<u>Pr.47</u>) stored in the AD75 with machine zero point return. (Positioning start No.9002)	8.3	
Main positioning control	Position control	Linear control (1-axis linear control) (2-axis linear interpolation control)	Positions with a linear path to the address set in the positioning data or the position designated with the movement amount.	9.2.2 9.2.3
		Fixed-dimension feed control (1-axis fixed-dimension feed control) (2-axis fixed-dimension feed control)	Positions the movement amount designated with the movement amount set in the positioning data. (With fixed-dimension feed control, the " <u>Md.29</u> Current feed value" is set to "0" when starting. With 2-axis fixed-dimension feed control, the linear path will be fixed-dimension fed with interpolation.	9.2.4 9.2.5
		2-axis circular interpolation control	Positions with an arc path to the address set in the positioning data, or the position designated with the movement amount, auxiliary point or center point.	9.2.6 9.2.7
	Speed control		Continuously outputs the pulses corresponding to the command speed set in the positioning data.	9.2.8
	Speed/position changeover control		First, carries out speed control, and then carries out position control (positioning of designated movement amount) by turning the "speed/position changeover signal" ON.	9.2.9
	Other control	Current value change	Changes the Current feed value (<u>Md.29</u>) to the address set in the positioning data. The following two methods can be used. (The machine feed value cannot be changed.) • Current value change using positioning data • Current value change using current value change start No. (No. 9003)	9.2.10
		JUMP command	Unconditionally or conditionally jumps to designated positioning data No.	9.2.11

Main functions		Details	Reference section
Advanced positioning control	Block start (Normal start)	With one start, executes the positioning data in a random block with the set order.	10.3.2
	Condition start	Carries out condition judgment set in the "condition data" for the designated positioning data, and then executes the "start block data". When the condition is established, the "start block data" is executed. When not established, that "start block data" is ignored, and the next point's "start block data" is executed.	10.3.3
	Wait start	Carries out condition judgment set in the "condition data" for the designated positioning data, and then executes the "start block data". When the condition is established, the "start block data" is executed. When not established, stops the control until the condition is established. (Waits.)	10.3.4
	Simultaneous start	Simultaneously executes the positioning data having the No. for the axis designated with the "condition data". (Outputs pulses at the same timing.)	10.3.5
	Stop	Stops the positioning operation.	10.3.6
	Repeated start (FOR loop)	Repeats the program from the start block data set with the "FOR loop" to the start block data set in "NEXT" for the designated No. of times.	10.3.7
	Repeated start (FOR condition)	Repeats the program from the start block data set with the "FOR condition" to the start block data set in "NEXT" until the conditions set in the "condition data" are established.	10.3.8
Manual control	JOG operation	Outputs a pulse to the drive unit while the JOG start signal is ON.	11.2
	Manual pulse generator operation	Outputs the pulses commanded with the manual pulse generator to the drive unit. (Carry out fine adjustment, etc., at the pulse level.)	11.3

With the "main positioning control" ("advanced positioning control"), whether or not to continuously execute the positioning data can be set with the "operation pattern".
Outlines of the "operation patterns" are given below.

Da.1 Operation pattern	Details	Reference section
Independent positioning control (positioning complete)	When "independent positioning control" is set for the operation pattern of the started positioning data, only the designated positioning data will be executed, and then the positioning will end.	9.1.2
Continuous positioning control	When "continuous positioning control" is set for the operation pattern of the started positioning data, after the designated positioning data is executed, the program will stop once, and then the next following positioning data will be executed.	
Continuous path control	When "continuous path control" is set for the operation pattern of the started positioning data, the designated positioning data will be executed, and then without decelerating, the next following positioning data will be executed.	

3.3.3 AD75 auxiliary functions and common functions

■ Auxiliary functions

The functions that assist positioning control using the AD75 are described below.
(Refer to "SECTION 2" for details on each function.)

Auxiliary function		Details	Reference section
Functions characteristic to machine zero point return	Zero point return retry function	This function retries the machine zero point return with the upper/lower limit switches during machine zero point return. This allows machine zero point return to be carried out even if the axis is not returned to before the near-point dog with JOG operation, etc.	12.2.1
	Zero point shift function	After returning to the machine zero point, this function compensates the position by the designated distance from the machine zero point position and sets that position as the zero point address.	12.2.2
Functions that compensate control	Backlash compensation function	This function compensates the mechanical backlash. Feed pulses equivalent to the set backlash amount are output each time the movement direction changes.	12.3.1
	Electronic gear function	By setting the movement amount per pulse, this function can freely change the machine movement amount per commanded pulse. When the movement amount per pulse is set, a flexible positioning system that matches the machine system can be structured.	12.3.2
	Near pass mode function	This function suppresses the machine vibration when the speed changes during continuous path control in the interpolation control.	12.3.3
Functions that limit control	Speed limit function	If the command speed exceeds "[Pr.7] Speed limit value" during control, this function limits the commanded speed to within the "[Pr.7] Speed limit value" setting range.	12.4.1
	Torque limit function *1	If the torque generated by the servomotor exceeds "[Pr.18] Torque limit setting value" during control, this function limits the generated torque to within the "[Pr.18] Torque limit setting value" setting range.	12.4.2
	Software stroke limit function	If a command outside of the upper/lower limit stroke limit setting range, set in the parameters, is issued, this function will not execute positioning for that command.	12.4.3
	Hardware stroke limit function	This function carries out deceleration stop with the limit switch connected to the AD75 external device connection connector.	12.4.4
Functions that change control details	Speed change function	This function changes the speed during positioning. Set the new speed in the speed change buffer memory ([Cd.16] New speed value), and change the speed with the Speed change request ([Cd.17]).	12.5.1
	Override function	This function changes the speed within a percentage of 1 to 300% during positioning. This is executed using "[Cd.18] Positioning operation speed override".	12.5.2
	Acceleration/deceleration time change function	This function changes the acceleration/deceleration time during speed change.	12.5.3
	Torque change function	This function changes the "torque limit value" during control.	12.5.4

*1 To carry out "torque limit", the "D/A conversion module" and a "drive unit capable of the torque limit command with an analog voltage" must be prepared.

Auxiliary function		Details	Reference section
Other functions	Step function	This function temporarily stops the operation to confirm the positioning operation during debugging, etc. The operation can be stopped at each "automatic deceleration" or "positioning data".	12.6.1
	Skip function	This function stops (decelerates to a stop) the positioning being executed when the skip signal is input, and carries out the next positioning.	12.6.2
	M code output function	This function issues an auxiliary work (clamp or drill stop, tool change, etc.) according to the code No. (0 to 32767) set for each positioning data.	12.6.3
	Teaching function	This function stores the address positioned with manual control into the positioning address having the designated positioning data No. (<u> Cd.5 </u>).	12.6.4
	Command in-position function	At each automatic deceleration, this function calculates the remaining distance for the AD75 to reach the positioning stop position, and when the value is less than the set value, sets the "command in-position flag". When using another auxiliary work before ending the control, use this function as a trigger for the auxiliary work.	12.6.5
	Stepping motor mode function	This function makes settings for using a stepping motor.	12.6.6
	Acceleration/deceleration process function	This function adjusts the control acceleration/deceleration.	12.6.7
	Indirectly specification function	This function specifies indirectly and starts the positioning data No.	12.6.8

■ Common functions

The outline of the functions executed as necessary are described below.
(Refer to "SECTION 2" for details on each function.)

Common functions	Details	Reference section
Parameter initialization function	This function returns the "setting data" stored in the AD75 flash ROM to the default values. The following two methods can be used. 1) Method using sequence program 2) Method using AD75 software package	13.2
Execution data backup function	This functions stores the "setting data", currently being executed, into the flash ROM. 1) Method using sequence program 2) Method using AD75 software package	13.3
LED display function	This function displays the AD75 operation state, signal state and error details on the 17-segment LED on the front of the main module. The display details can be changed with the mode switch on the front of the main module.	13.4
Clock data function	This function sets the PLC CPU clock data in the AD75. This used for the various history data.	13.5

3.3.4 Combination of AD75 main functions and auxiliary functions

With positioning control using the AD75, the main functions and auxiliary functions can be combined and used as necessary. A list of the main function and auxiliary function combinations is given below.

Main functions		Auxiliary functions	Functions characteristic to machine zero point return		
			Zero point return retry function	Zero point shift function	
		Combination with operation pattern.*1			
Zero point return control	Machine zero point return control		×	○	○
	High-speed zero point return control		×	-	-
Main positioning control	Position control	1-axis linear control	○	-	-
		2-axis linear interpolation control	○	-	-
		1-axis fixed-dimension feed control	△ (Continuous path control cannot be set)	-	-
		2-axis fixed-dimension feed control (interpolation)	△ (Continuous path control cannot be set)	-	-
		2-axis circular interpolation control	○	-	-
	Speed control		△ (Only independent positioning control can be set)	-	-
	Speed/position changeover control		△ (Continuous path control cannot be set)	-	-
	Other control	Current value change	△ (Continuous path control cannot be set)	-	-
JUMP command		△ (Independent positioning control cannot be set)	-	-	
Manual control	JOG operation		×	-	-
	Manual pulse generator operation		×	-	-

◎: Always combine, ○: Combination possible, △: Combination limited, ×: Combination not possible, -: Setting invalid

*1 The operation pattern is one of the "positioning data" setting items.

*2 Disabled for a start of positioning start No. 9003.

	Functions that compensate control			Functions that limit control				Functions that change control details				Other functions							
	Backlash compensation function	Electronic gear function	Near pass mode function	Speed limit function	Torque limit function	Software stroke limit function	Hardware stroke limit function	Speed change function	Override function	Acceleration/ deceleration time change function	Torque change function	Step function	Skip function	M code output function	Teaching function	Command in-position function	Stepping motor mode function	Acceleration/deceleration process function	Indirectly specification function
	○	○	×	○	○	×	◎	△	△	×	○	×	×	×	×	×	○	○	×
	○	○	×	○	○	×	◎	○	○	×	○	×	×	×	×	×	○	○	×
	○	○	○	○	○	○	◎	○	○	○	○	○	○	○	×	○	○	○	○
	○	○	○	○	○	○	◎	○	○	○	○	○	○	○	×	○	○	○	○
	○	○	○	○	○	○	◎	○	○	○	○	○	○	○	×	○	○	○	○
	○	○	○	○	○	○	◎	○	○	○	○	○	○	○	×	○	×	○	○
	○	○	×	○	○	○	◎	○	○	○	○	×	×	○	×	×	○	○	○
	○	○	×	○	○	○	◎	○	○	○	○	○	○	○	×	○	○	○	○
	-	-	-	-	-	-	◎	-	-	-	-	-	-	-	-	-	-	-	△*2
	-	-	-	-	-	-	◎	-	-	-	-	-	-	-	-	-	-	-	○
	○	○	×	○	○	○	◎	○	○	×	○	×	×	×	○	×	○	○	-
	○	○	×	×	○	○	◎	×	×	×	○	×	×	×	○	×	×	×	-

REMARK

- The "common functions" are functions executed as necessary. (These are not combined with the control.)
- "Advanced positioning control" is a control used in combination with the "main positioning control". For combinations with the auxiliary functions, refer to the combinations of the "main positioning control" and auxiliary functions.

3.4 Specifications of input/output signals with PLC CPU

3.4.1 List of input/output signals with PLC CPU

The AD75 uses 32 input points and 32 output points for exchanging data with the PLC CPU.

The input/output signals for when the AD75 is mounted in slot No. 0 of the main base unit are shown below.

Device X refers to the signals input from the AD75 to the PLC CPU, and device Y refers to the signals output from the PLC CPU to the AD75.

Signal direction: AD75 → PLC CPU			Signal direction: PLC CPU → AD75		
Device No.	Signal name		Device No.	Signal name	
X0	AD75 READY		Y0 ↓	Use prohibited	
X1	Axis 1	Start complete			
X2	Axis 2				
X3	Axis 3				
X4	Axis 1	BUSY			
X5	Axis 2				
X6	Axis 3				
X7	Axis 1	Positioning complete			
X8	Axis 2				
X9	Axis 3				
XA	Axis 1	Error detection			
XB	Axis 2				
XC	Axis 3				
XD	Axis 1	M code ON			
XE	Axis 2				
XF	Axis 3				
X10 ↓ X1F	Use prohibited		Y10	Axis 1	Positioning start
			Y11	Axis 2	
			Y12	Axis 3	
			Y13	Axis 1	Axis stop
			Y14	Axis 2	
			Y15	Use prohibited	
			Y16	Axis 1	Forward run JOG start
			Y17	Axis 1	Reverse run JOG start
			Y18	Axis 2	Forward run JOG start
			Y19	Axis 2	Reverse run JOG start
			Y1A	Axis 3	Forward run JOG start
			Y1B	Axis 3	Reverse run JOG start
			Y1C	Axis 3	Axis stop
			Y1D	PLC READY	
			Y1E	Use prohibited	
Y1F					

Important

[Y15], [Y1E], [Y1F], [Y0 to YF] and [X10 to X1F] are used by the system, and cannot be used by the user.

If used, the operation of the AD75 will not be guaranteed.

Note that when the AD75 is mounted on the remote I/O station, [YD] to [YF] can be turned OFF in the user program.

3.4.2 Details of input signals (AD75 → PLC CPU)

The ON/OFF timing and conditions, etc., of the input signals are shown below.

Device No.	Signal name		Details
X0	AD75 READY		<p>OFF: READY complete ON : Not ready/WDT error *3</p> <ul style="list-style-type: none"> When the PLC READY signal [Y1D] turns from OFF to ON, the parameter setting range is checked, and if there is no error, this signal turns OFF. When the PLC READY signal [Y1D] turns OFF, this signal turns ON. When a WDT error occurs, this signal turns ON. This is used for the interlock with the sequence program, etc.
X1 X2 X3	Axis 1 Axis 2 Axis 3	Start complete	<p>OFF: Starting incomplete ON : Start complete</p> <ul style="list-style-type: none"> When the positioning start signal turns ON, and the AD75 starts the positioning process, this signal turns ON. (The start complete signal also turns ON during zero point return control.)
X4 X5 X6	Axis 1 Axis 2 Axis 3	BUSY *1	<p>OFF: Not BUSY ON : BUSY</p> <ul style="list-style-type: none"> This signal turns ON at the start of positioning, zero point return or JOG, and turns OFF after the "[Da.8] Dwell time" has passed after positioning stop. (This signal remains ON during positioning.) This signal turns OFF when stopped with step operation. During manual pulse generator operation, this signal turns ON while the "[Cd.22] Manual pulse generator enable flag" is ON. This signal turns OFF at an error complete or stop.
X7 X8 X9	Axis 1 Axis 2 Axis 3	Positioning complete *2	<p>OFF: Positioning incomplete ON : Positioning complete</p> <ul style="list-style-type: none"> This signal turns ON for the time set in "[Pr.41] Positioning complete signal output time" from the time that each positioning data No. positioning control is completed. (This does not turn ON when "[Pr.41] Positioning complete signal output time" is 0.) If positioning is started (including zero point return), JOG operation or manual pulse generator operation start is executed while this signal is ON, the signal will turn OFF. This signal will not turn ON when speed control or positioning is canceled midway. After the BUSY signal [X4,X5,X6] turns OFF, the positioning complete signal [X7,X8,X9] turns ON.
XA XB XC	Axis 1 Axis 2 Axis 3	Error detection	<p>OFF: No error ON : Error occurrence</p> <ul style="list-style-type: none"> This signal turns ON when an error listed in section 14.1 occurs, and turns OFF when the error is reset.
XD XE XF	Axis 1 Axis 2 Axis 3	M code ON	<p>OFF: No M code setting ON : M code set</p> <ul style="list-style-type: none"> In the WITH mode, this signal turns ON when the positioning data is started, and in the AFTER mode, this signal turns ON when the positioning data positioning is completed. This signal turns OFF with the "[Cd.14] M code OFF request". When there is no M code designated (when "[Da.9] M code" is 0), this signal will remain OFF. With using continuous path control for the positioning operation, the positioning will continue even when this signal does not turn OFF. However, a warning will occur. (Warning code: 503) When the PLC READY signal [Y1D] turns OFF, the M code ON signal will also turn OFF. If operation is started while the M code is ON, an error will occur. (Error code: 536)

Important

- *1 When position control of movement amount 0 is executed, the BUSY signal also turns ON. However, since the ON time is short, the ON status may not be detected in the sequence program.
- *2 AD75 positioning complete refers to when the output of pulses from AD75 is completed. Thus, even if the AD75 positioning complete signal turns ON, the system may continue to operate.
- *3 If WDT error occurs, status of I/O signals cannot be checked by the monitor function of GX Configurator-AP.
To check the status of WDT error by the AD75 READY signal [X0], use the device monitor of GX Developer.

3.4.3 Details of output signals (PLC CPU → AD75)

The ON/OFF timing and conditions, etc., of the output signals are shown below.

Device No.	Signal name		Details
Y10 Y11 Y12	Axis 1 Axis 2 Axis 3	Positioning start	OFF : No positioning start request ON : Positioning start requested <ul style="list-style-type: none"> • Zero point return or positioning operation is started. • The positioning start signal is valid at the rising edge, and carries out starting. • When the positioning start signal turns ON during BUSY, the warning "start during operation" (warning code: 100) will occur.
Y13 Y14 Y1C	Axis 1 Axis 2 Axis 3	Axis stop	OFF : No axis stop request ON : Axis stop requested <ul style="list-style-type: none"> • When the axis stop signal turns ON, the zero point return control, positioning control, JOG operation and manual pulse generator operation will stop. • By turning the axis stop signal ON during positioning operation, the positioning operation will be "stopped". • Whether to decelerate or suddenly stop for each stop group can be selected with "[Pr.38] Stop group 1 sudden stop selection" to "[Pr.40] Stop group 3 sudden stop selection". • During interpolation control of the positioning operation, if the axis stop signal for either axis turns ON, both axes will decelerate and stop.
Y15	Use prohibited		
Y16 Y17 Y18 Y19 Y1A Y1B	Axis 1 Axis 1 Axis 2 Axis 2 Axis 3 Axis 3	Forward run JOG start Reverse run JOG start Forward run JOG start Reverse run JOG start	OFF : JOG not started ON : JOG started <ul style="list-style-type: none"> • When the JOG start signal is ON, JOG operation will be carried out at the "[Cd.19] JOG speed". When the JOG start signal turns OFF, the system will decelerate and stop.
Y1D	PLC READY	OFF : PLC READY OFF ON : PLC READY ON	(a) This signal notifies the AD75 that the PLC CPU is normal. <ul style="list-style-type: none"> • This is turned ON/OFF with the sequence program. • The PLC READY signal is turned ON during positioning control, zero point return control, JOG operation and manual pulse generator operation, except for in the peripheral device test mode. (b) When data (parameters, etc) are changed, the PLC READY signal will turn OFF depending on the item. (Refer to Chapter 7.) (c) The following processes are carried out when the PLC READY signal turns from OFF to ON. <ul style="list-style-type: none"> • The parameter setting range is checked. • The AD75 READY signal [X0] turns OFF. (d) The following processes are carried out when the PLC READY signal turns from ON to OFF. In this case, the OFF time will be 100ms or more. <ul style="list-style-type: none"> • The AD75 READY complete signal [X0] turns ON. • The operating axis stops. • The M code ON signal [XD to XF] for each axis turns OFF, and "0" is stored in "[Md.32] Valid M code". (e) When parameters or positioning data (No.1 to 100) are written from the peripheral device or PLC CPU to the flash ROM, the PLC READY signal will turn OFF.

3.5 Specifications of input/output interfaces with external devices

3.5.1 Electrical specifications of input/output signals

■ Input specifications

Signal name	Rated input voltage/current	Working voltage range	ON voltage/current	OFF voltage/current	Input resistance	Response time
Drive unit READY (READY) In-position signal	24VDC/5mA	19.2 to 26.4VDC	17.5VDC or more/ 3.5mA or more	7VDC or less/ 1.7mA or less	Approx. 4.7kΩ	4ms or less
Zero point signal (PG0)	5VDC/5mA	4.5 to 6.1VDC	2.5VDC or more/ 2mA or more	0.5VDC or less/ 0.5mA or less	Approx. 0.5kΩ	0.8ms or less
	24VDC/7mA	12 to 26.4VDC	10VDC or more/ 3mA or more	3VDC or less/ 0.2mA or less	Approx. 3.5kΩ	0.8ms or less
Manual pulse generator A phase (PULSE GENERATOR A) Manual pulse generator B phase (PULSE GENERATOR B)	5VDC/5mA	4.5 to 6.1VDC	2.5VDC or more/ 3.5mA or more	1VDC or less/ 0.1mA or less	Approx. 1.5kΩ	1ms or less
	<p>1) Pulse width</p> <p>(Duty ratio 50%)</p> <p>2) Phase difference</p> <p>When the A phase has advanced more than the B phase, the positioning address (current value) increases.</p>					
Near-point dog signal (DOG) Stop signal (STOP) Upper limit signal (FLS) Lower limit signal (RLS) External start signal (STRT) Speed/position changeover signal (CHG)	24VDC/5mA	19.2 to 26.4VDC	17.5VDC or more/ 3.5mA or more	7VDC or less/ 1.7mA or less	Approx. 4.7kΩ	4ms or less

■ Output specifications

Signal name	Rated load voltage	Working load voltage range	Max. load current/rush current	Max. voltage drop at ON	Leakage current at OFF	Response time																												
Pulse output (CW/PULSE/A phase) Pulse sign (CCW/SIGN/B phase)	<ul style="list-style-type: none"> Differential driver/open collector equivalent to Am26LS31 Select the CW/CCW type, PULSE/SIGN type and A phase/B phase type using the parameter (Pr.5 Pulse output mode) according to the drive unit specifications. The relation of the pulse output with the "Pr.5 Pulse output mode" and "Pr.24 Logic selection for pulse output to drive unit" is as shown below. <table border="1" style="width: 100%; border-collapse: collapse;"> <thead> <tr> <th rowspan="3">Pr.5 Pulse output mode</th> <th colspan="4">Pr.24 Logic selection for pulse output to drive unit</th> </tr> <tr> <th colspan="2">Positive logic</th> <th colspan="2">Negative logic</th> </tr> <tr> <th>Forward run</th> <th>Reverse run</th> <th>Forward run</th> <th>Reverse run</th> </tr> </thead> <tbody> <tr> <td>CW CCW</td> <td></td> <td></td> <td></td> <td></td> </tr> <tr> <td>PULSE SIGN</td> <td></td> <td></td> <td></td> <td></td> </tr> <tr> <td>Aφ Bφ</td> <td></td> <td></td> <td></td> <td></td> </tr> </tbody> </table> <p>When using the open collector, the rising edge/falling edge time and duty ratio will be as shown below. *</p> <div style="text-align: center;"> </div>						Pr.5 Pulse output mode	Pr.24 Logic selection for pulse output to drive unit				Positive logic		Negative logic		Forward run	Reverse run	Forward run	Reverse run	CW CCW					PULSE SIGN					Aφ Bφ				
	Pr.5 Pulse output mode	Pr.24 Logic selection for pulse output to drive unit																																
Positive logic		Negative logic																																
Forward run		Reverse run	Forward run	Reverse run																														
CW CCW																																		
PULSE SIGN																																		
Aφ Bφ																																		
	5 to 24VDC	4.75 to 30VDC	50mA/point/ 200mA 10ms or less	0.5VDC (TYP)	0.1mA or less	—																												
Deviation counter clear (CLEAR)	5 to 24VDC	4.25 to 30VDC	0.1A/point/ 0.4A 10ms or less	1VDC (TYP) 2.5VDC (MAX)	0.1mA or less	2ms or less (resistance load)																												

* Pulse rising edge/falling edge time in AD75 (unit tr, tf: μs Duty: %) ... When ambient temperature is room temperature



Load voltage (V)		26.4						4.75					
Cable length (m)		1			3			1			3		
Load current (mA)	Pulse speed (kpps)	tr (rising edge)	tf (falling edge)	Duty	tr (rising edge)	tf (falling edge)	Duty	tr (rising edge)	tf (falling edge)	Duty	tr (rising edge)	tf (falling edge)	Duty
2	200	1.70	0.04	30	2.04	0.06	27	0.63	0.04	43	1.08	0.04	38
	100	3.00	0.08	33	3.49	0.07	29	0.64	0.06	47	1.28	0.04	42
	10	3.20	0.07	48	6.80	0.08	46	0.64	0.04	49	1.30	0.06	49
5	200	1.10	0.06	39	1.83	0.07	33	0.26	0.04	48	0.92	0.04	46
	100	1.24	0.07	43	2.50	0.08	36	0.26	0.05	48	0.44	0.06	47
	10	1.20	0.07	49	2.70	0.08	49	0.30	0.05	50	0.44	0.06	50
20	200	0.42	0.07	46	0.72	0.08	43	0.22	0.06	47	0.22	0.06	49
	100	0.40	0.07	48	0.74	0.11	47	0.24	0.08	50	0.24	0.06	50
	10	0.40	0.07	50	0.79	0.08	50	0.24	0.06	50	0.24	0.06	50
50	200	0.28	0.08	48	0.37	0.09	47	0.20	0.08	47	0.18	0.10	50
	100	0.27	0.08	48	0.37	0.13	48	0.22	0.08	49	0.20	0.12	51
	10	0.27	0.09	50	0.37	0.09	50	0.22	0.08	50	0.20	0.12	50

3.5.2 Signal layout for external device connection connector

The specifications of the connector section, which is the input/output interface for the AD75 and external device, are shown below.

The signal layout for the AD75 external device connection connector (for one axis) is shown.

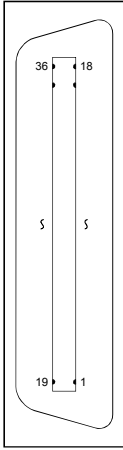
(The signal layout for the external device connection connector is the same for axis 1 to axis 3.)

Pin layout	Pin No.	Signal name		Signal direction AD75 – external	Connection destination	
<p>A1SD75P1-S3/A1SD75P2-S3/A1SD75P3-S3 (Main body side)</p> 	36	Common	COM	↔	(External device)	
	35	Common	COM	↔	(External device)	
	34	Open				
	↓	↓				
	29	Open				
	28	Manual pulse generator	PULSER B-	←	Manual pulse generator	
	27	Manual pulse generator	PULSER A-	←	Manual pulse generator	
	26	Common	COM	↔	Drive unit	
	25	Zero point signal common	PG0 COM	↔	Drive unit	
	24	Zero point signal	PG0 (5V)	←	Drive unit	
	23	Deviation counter clear common	CLEAR COM	↔	Drive unit	
	22	Pulse sign (differential driver -)	PULSE R-	→	Drive unit	
	21	Pulse output (differential driver -)	PULSE F-	→	Drive unit	
	20	Pulse sign common (Open collector)	PULSE COM	↔	Drive unit	
	19	Pulse output common (Open collector)	PULSE COM	↔	Drive unit	
	18	Open				
	<p>AD75P1-S3/AD75P2-S3/AD75P3-S3 (Main body side)</p> 	17	Open			
		16	External start signal *	STRT	←	(External device)
		15	Speed/position changeover signal	CHG	←	(External device)
14		Stop signal	STOP	←	(External device)	
13		Lower limit signal	RLS	←	Limit switch	
12		Upper limit signal	FLS	←	Limit switch	
11		Near-point dog signal	DOG	←	Near-point dog	
10		Manual pulse generator	PULSE B+	←	Manual pulse generator	
9		Manual pulse generator	PULSE A+	←	Manual pulse generator	
8		In-position	INPS	←	Drive unit	
7		Drive unit READY	READY	←	Drive unit	
6		Zero point signal	PG0 (24V)	←	Drive unit	
5		Deviation counter clear	CLEAR	→	Drive unit	
4		Pulse sign (differential driver +)	PULSE R+	→	Drive unit	
3	Pulse output (differential driver +)	PULSE F+	→	Drive unit		
2	Pulse sign (Open collector)	PULSE R	→	Drive unit		
1	Pulse output (Open collector)	PULSE F	→	Drive unit		

* The signal application follows "[Pr.43] External start function selection".

3.5.3 List of input/output signal details

The details of each AD75 external device connection connector (for 1 axis) signal are shown below.

Signal name	Pin No.	Signal details
Common	36 35	<ul style="list-style-type: none"> Common for near-point dog signal, upper/lower limit, stop signal, speed/position changeover signal, and external start signal.
Manual pulse generator (B phase -) Manual pulse generator (A phase -)	28 27	<ul style="list-style-type: none"> Input the pulse signal from the manual pulse generator A phase and B phase. If the A phase is advanced more than the B phase, the positioning address will increase at the rising edge and falling edge of each phase. If the B phase is advanced more than the A phase, the positioning address will decrease at the rising edge and falling edge of each phase.
Manual pulse generator (B phase +) Manual pulse generator (A phase +)	10 9	<p>[When increased]</p> <p>[When decreased]</p> <p>Positioning address +1+1+1+1+1+1+1</p> <p>Positioning address -1 -1 -1 -1 -1 -1 -1</p>
Common	26	<ul style="list-style-type: none"> Common for drive unit READY and in-position.
Deviation counter clear common	23	<ul style="list-style-type: none"> Common for deviation counter clear.
Zero point signal common	25	<ul style="list-style-type: none"> Common for zero point signal (+5V) and zero point signal (+24V).
Zero point signal (+5V) Zero point signal (+24V)	24 6	<ul style="list-style-type: none"> Input the zero point signal for machine zero point return. Use the zero point signal of the pulse encoder or the like. Use this signal when the zero point return method is the stopper method and the machine zero point return complete is input from an external source. The zero point signal is detected at turning from OFF to ON.
Pulse sign Pulse output (differential driver -)	22 21	<ul style="list-style-type: none"> Output the positioning pulses and pulse sign for the differential driver compatible drive unit.
Pulse sign Pulse output (differential driver +)	4 3	
Pulse sign common Pulse output common (Open collector)	20 19	<ul style="list-style-type: none"> Output the positioning pulses and pulse sign for the open collector compatible drive unit.
Pulse sign Pulse output (Open collector)	2 1	
External start signal	16	<ul style="list-style-type: none"> Use as the positioning start, speed change request and skip request input signal from an external source. Set which function to use the external start signal with in "Pr.43 External start function selection".
Speed/position changeover signal	15	<ul style="list-style-type: none"> Input the control changeover signal for the speed/position changeover control.
Stop signal	14	<ul style="list-style-type: none"> Input when positioning is stopped. When this signal turns ON, the AD75 will stop the positioning being executed. After that, even if this signal turns from ON for OFF, the system will not start.

Signal name	Pin No.	Signal details
Lower limit signal	13	<ul style="list-style-type: none"> This signal is input from the limit switch installed at the stroke lower limit position. Positioning will stop when this signal turns OFF. When zero point return retry function is valid, this will be the lower limit for finding the near-point dog signal.
Upper limit signal	12	<ul style="list-style-type: none"> This signal is input from the limit switch installed at the stroke upper limit position. Positioning will stop when this signal turns OFF. When zero point return retry function is valid, this will be the upper limit for finding the near-point dog signal.
Near-point dog signal	11	<ul style="list-style-type: none"> Use this for detecting the near-point dog during machine zero point return. The near-point dog signal is detected at turning from OFF to ON.
In-position	8	<ul style="list-style-type: none"> Input the in-position signal from the drive unit.
Drive unit READY	7	<ul style="list-style-type: none"> This signal turns ON when the drive unit is normal and the feed pulse can be accepted. The AD75 checks the drive unit READY signal, and outputs the zero point return request when not in the READY state. When the drive unit is inoperable, such as if an error occurs in the drive unit's control power, this signal will turn OFF. If this signal turns OFF during positioning, the system will stop. The system will not start even if this signal is turned ON again. When this signal turns OFF, the zero point return complete signal will also turn OFF.
Deviation counter clear	5	<ul style="list-style-type: none"> Output during machine zero point return. (Note that this signal is not output during the count method 2.) (Example) When carry out machine zero point return with stopper stop method 2) <ul style="list-style-type: none"> The deviation counter clear is output for approx. 10ms. When the AD75 turns this signal ON, the drive unit uses this signal to reset the droop pulse amount in the internal deviation counter. (Note) The deviation counter clear is a signal output by the AD75 during machine zero point return. It cannot be output randomly by the user.

3.5.4 Input/output interface internal circuit

The outline diagram of the internal circuit for the AD75 external device connection interface is shown below.

Input/output class	External wiring	Pin No.	Internal circuit	Signal name	Need for wiring *1	
Input		11		Near-point dog signal	DOG	△
		12		Upper limit signal	FLS	○
		13		Lower limit signal	RLS	○
		14		Stop signal	STOP	△
		15		Speed/position changeover signal	CHG	△
		16		External start signal	STRT	△
		35		Common	COM	○
		36				
		(+) 9		Manual pulse generator A phase	PULSER A+	△
		(-) 27			PULSER A-	
		(+) 10		Manual pulse generator B phase	PULSER B+	△
		(-) 28			PULSER B-	
		7		Drive unit READY	READY	○
		8		In-position signal	INPS	△
		26		Common	COM	○
		6				
		24		Zero point signal	PG0	△
		25		Common	PG0 COM	

*1: The meaning of "O" and "△" in the "need for wiring" column is as follows.

- : Wiring is necessary in positioning.
- △: Perform wiring when necessary.

*2: The terminal connected to the common line may be either positive or negative.

Input/output class	External wiring	Pin No.	Internal circuit	Signal name		Need for wiring *1	
Output		5		Deviation counter clear	CLEAR	△	
		23		Common	CLEAR COM		
		1		Open collector	CW A phase PULSE	PULSE F	○*2
		19				PULSE COM	
		2			CCW B phase SIGN	PULSE R	
		20			PULSE COM		
		3 (+)		Differential driver	CW A phase PULSE	PULSE F+	○*2
		21 (-)				PULSE F-	
		4 (+)			CCW B phase SIGN	PULSE R+	
		22 (-)				PULSE R-	

*1: The meaning of "O" and "△" in the "need for wiring" column is as follows.

- ○: Wiring is necessary in positioning.
- △: Perform wiring when necessary.

*2: Select the open collector output or differential driver output according to the drive unit being used.

Chapter 4

INSTALLATION, WIRING AND MAINTENANCE OF THE PRODUCT

The installation, wiring and maintenance of the AD75 are explained in this chapter.

Important information such as precautions to prevent malfunctioning of the AD75, accidents and injuries as well as the proper work methods are described.

Read this chapter thoroughly before starting installation, wiring or maintenance, and always following the precautions.

4.1	Outline of installation, wiring and maintenance	4-2
4.1.1	Installation, wiring and maintenance procedures	4-2
4.1.2	Names of each part	4-3
4.1.3	Handling precautions	4-5
4.2	Installation	4-7
4.2.1	Precautions for installation	4-7
4.3	Wiring	4-8
4.3.1	Precautions for wiring	4-8
4.3.2	Wiring the external device connection connector pins	4-13
4.3.3	Connecting the connector.....	4-17
4.4	Confirming the installation and wiring	4-18
4.4.1	Items to confirm when installation and wiring are completed.....	4-18
4.4.2	Single module test	4-19
4.5	Maintenance	4-23
4.5.1	Precautions for maintenance.....	4-23
4.5.2	Disposal instructions.....	4-23

4.1 Outline of installation, wiring and maintenance

4.1.1 Installation, wiring and maintenance procedures

The outline and procedures for AD75 installation, wiring and maintenance are shown below.

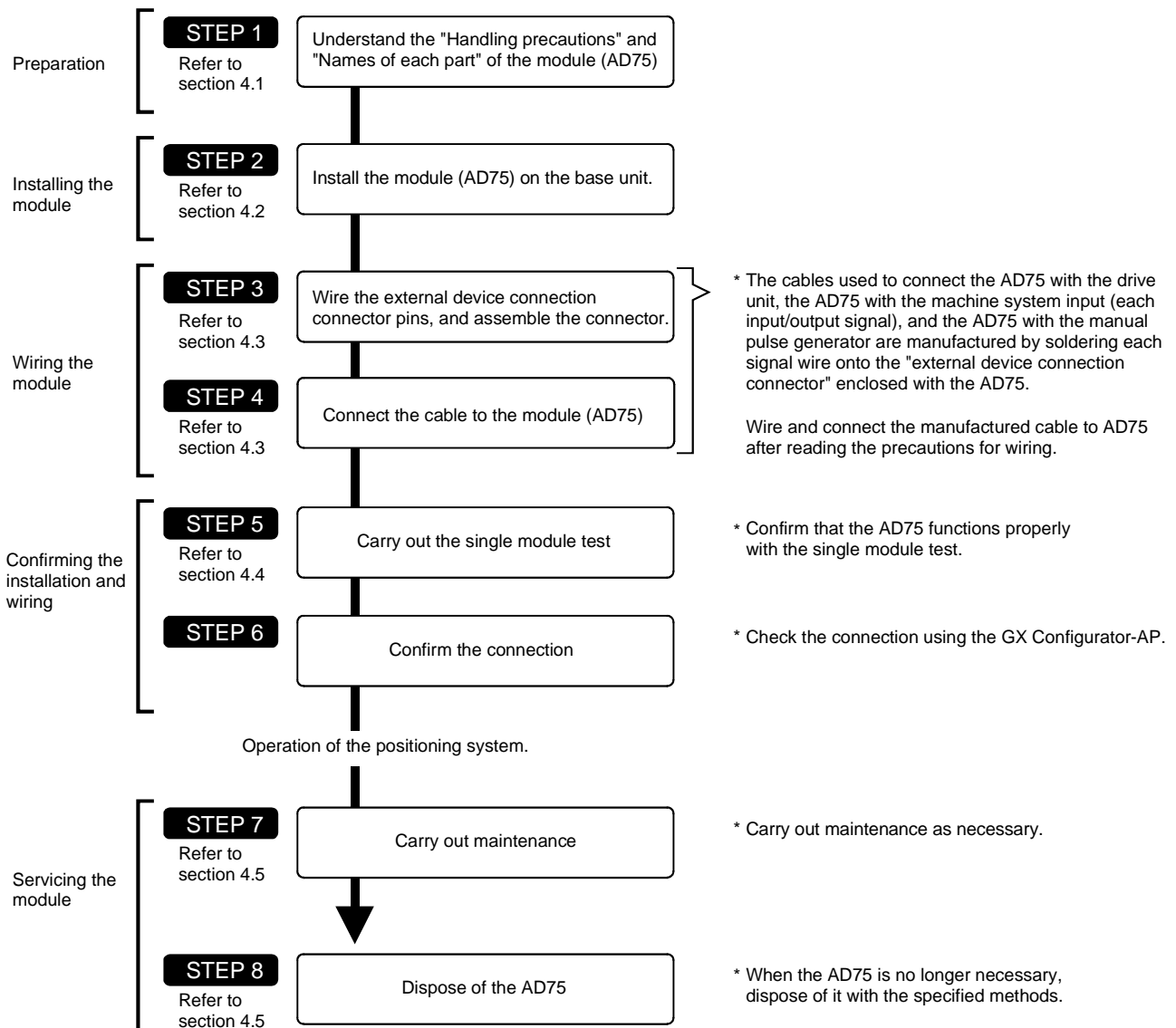

4.1.2 Names of each part

The names of each AD75 part are shown below.

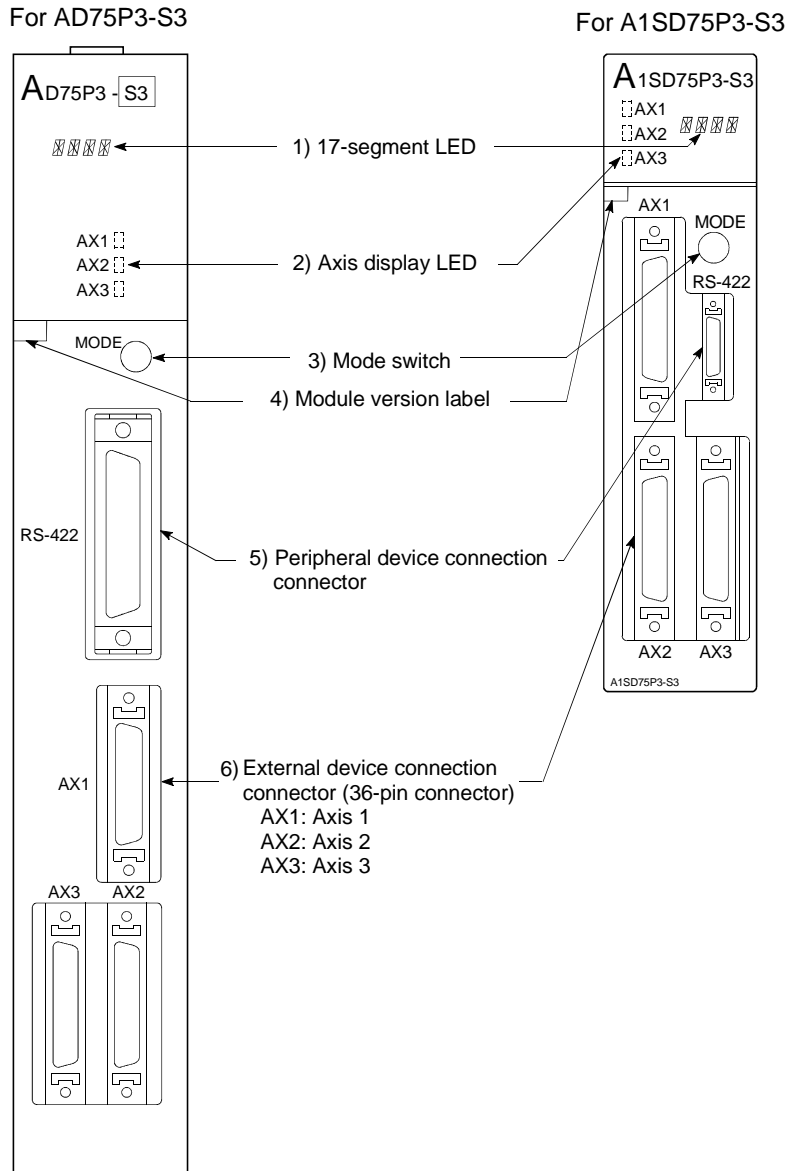

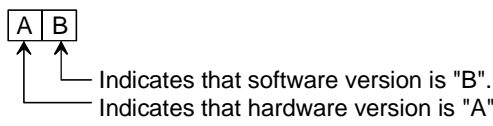
No.	Name	Details
1)	17-segment LED	Display the operating status (1)) of the target axis (2)) for that axis. RUN : The LED corresponding to the operating axis flickers. TEST: The LEDs of all axes turn ON.
2)	Axis display LED (AX1 to 3)	IDL : OFF ERR : The LED corresponding to the axis in error flickers.
3)	Mode switch	Each time this switch is pressed, the details displayed on "1) 17-segment LED" and "2) Axis display LED" will change. [Display details] Operation monitor 1 → Operation monitor 2 Stepping motor mode ← Internal information 1 Input/output information n ← Internal information 2 (Refer to section "13.4 LED display function" for details on the displayed information.)
4)	Module version label	This label indicates the module's software version and hardware version. (Example) 
5)	Peripheral device connection connector	Connector for connecting with peripheral device.
6)	External device connection connector	Connector for connecting drive unit, mechanical system input and manual pulse generator.

Each AD75 interface is as shown below.

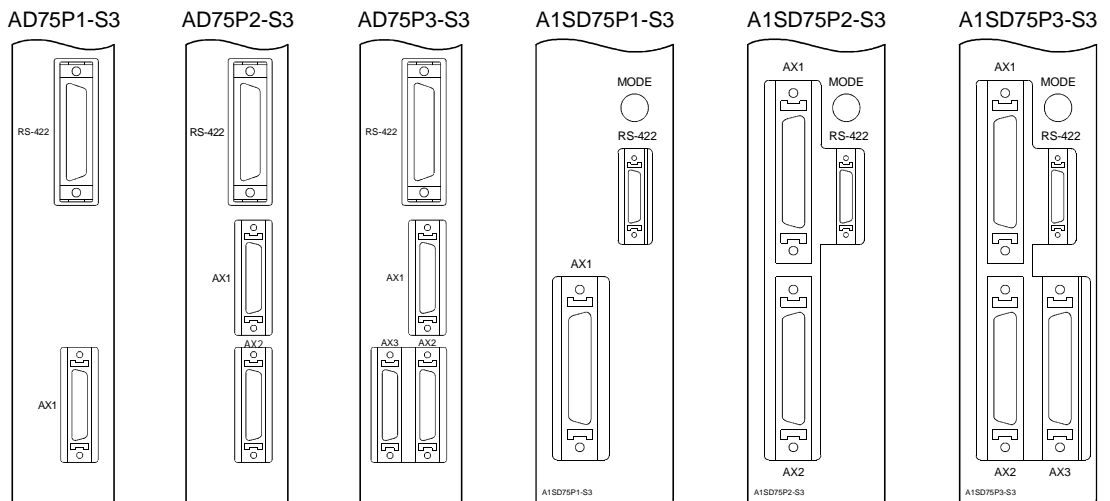

4.1.3 Handling precautions

Handle the AD75 and cable while observing the following precautions.

(1) Handling precautions

CAUTION

- Use the PLC within the general specifications environment given in this manual.
Using the PLC outside the general specification range environment could lead to electric shocks, fires, malfunctioning, product damage or deterioration.
- Do not directly touch the conductive section and electronic parts of the module.
Failure to observe this could lead to module malfunctioning or trouble.
- When not connecting a drive unit or peripheral device, always install a cover on the connector section.
Failure to observe this could lead to malfunctioning.
- Make sure that foreign matter, such as cutting chips or wire scraps, do not enter the module.
Failure to observe this could lead to fires, trouble or malfunctioning.
- Never disassemble or modify the module.
Failure to observe this could lead to trouble, malfunctioning, injuries or fires.

(2) Other precautions

(a) Main body

- The main body case is made of plastic. Take care not to drop or apply strong impacts onto the case.
- Do not remove the AD75 PCB from the case. Failure to observe this could lead to faults.

(b) Cable

- Do not press on the cable with a sharp object.
- Do not twist the cable with force.
- Do not forcibly pull on the cable.
- Do not step on the cable.
- Do not place objects on the cable.
- Do not damage the cable sheath.

(c) Installation environment

Do not install the module in the following type of environment.

- Where the ambient temperature exceeds the 0 to 55°C range.
- Where the ambient humidity exceeds the 10 to 90%RH range.
- Where there is sudden temperature changes, or where dew condenses.
- Where there is corrosive gas or flammable gas.
- Where there are high levels of dust, conductive powder, such as iron chips, oil mist, salt or organic solvents.
- Where the module will be subject to direct sunlight.
- Where there are strong electric fields or magnetic fields.
- Where vibration or impact could be directly applied onto the main body.

4.2 Installation

4.2.1 Precautions for installation

The precautions for installing the AD75 are given below. Refer to this section as well as section "4.1.3 Handling precautions" when carrying out the work.

(1) Precautions for installation

DANGER

- Switch off all phases of the externally supplied power used in the system before cleaning or tightening the screws.
Failure to turn all phases OFF could lead to electric shocks.

CAUTION

- Never disassemble or modify the module.
Failure to observe this could lead to trouble, malfunctioning, injuries or fires.
- Switch off all phases of the externally supplied power used in the system before installing or removing the module.
Failure to turn all phases OFF could lead to module trouble or malfunctioning.
- Use the PLC within the general specifications environment given in this manual.
Using the PLC outside the general specification range environment could lead to electric shocks, fires, malfunctioning, product damage or deterioration.
- Always securely insert the module latches at the bottom of the module into the fixing holes on the base unit. (Always screw the AnS Series module onto the base unit with the specified torque.) Improper mounting of the module could lead to malfunctioning, faults or dropping.

(2) Precautions for mounting

When mounting the AD75 onto the base unit (main base unit, extension base unit), observe the following points.

- (a) Avoid mounting the AD75 onto an extension base unit (A5□B/A1S5□B) that has no power supply module.
When mounting on this type of unit, take the power capacity and extension cable voltage drop into consideration.
- (b) If the temperature in the panel could exceed 55 °C, consider forcibly ventilating in the PLC panel.

4.3 Wiring

The wiring precautions for the AD75 are described below. Be careful to observe the following items together with the "Handling precautions" described in section 4.1.3.

4.3.1 Precautions for wiring

- (1) Perform wiring of the AD75 correctly while checking the terminal arrangement. (For the terminal arrangement of the external device connection connector, refer to section 3.5.2 "Signal layout for external device connection connector.")
- (2) Solder or crimp the external device connection connector correctly. An improperly soldered or crimped connector may cause malfunctions.
- (3) Be careful to avoid entry of chips, wiring dust and so on inside the AD75. Otherwise fire, failure or malfunction may be caused.
- (4) Be sure to install a cover for the external device connection connector if no external device is connected. Otherwise malfunction may be caused.
- (5) Connect the external device connection connector and peripheral device connection connector with the connector of the AD75. Check that the connector snaps. An improperly connected connector will cause poor continuity, possibly causing erroneous inputs or outputs.
- (6) Do not pull the cable when removing the cable from the AD75 or drive unit. Hold and pull the connector connected to the AD75 or drive unit. If the cable connected to the AD75 or drive unit is pulled, a malfunction may be caused. As well, the AD75, drive unit or cable may be broken.
- (7) Disconnect the external device connection connector when the system is stopped.
If the external device connection connector is disconnected during operation of the system, the system will be stopped.
- (8) Route the cables connected to the AD75, in a duct, or fix them. If cables are not routed in the duct or no fixing measures are taken to them, drifting or moving cables, breakage of the AD75, drive unit or cable due to a carelessly pulled cable, or malfunction caused by a poorly connected cable may be caused.
- (9) Do not tie the AD75 cable with the main circuit cable, power cable, or a load cable for other than the programmable controller or do not route the AD75 cable near them. Separate these by 100 mm as a measure. Otherwise noise, surge or induction may cause a malfunction.
- (10) When routing the AD75 cable near a power cable at a distance smaller than 100 mm, use a shielded cable for a countermeasure against noise. Connect the shielding wire of the shielded cable securely to the panel of the AD75.

[Shielding wire processing example]

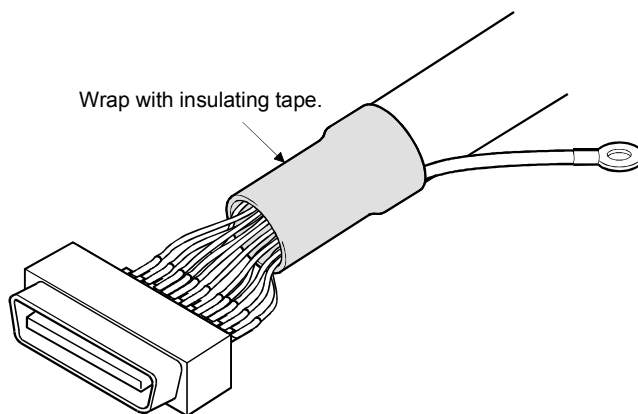
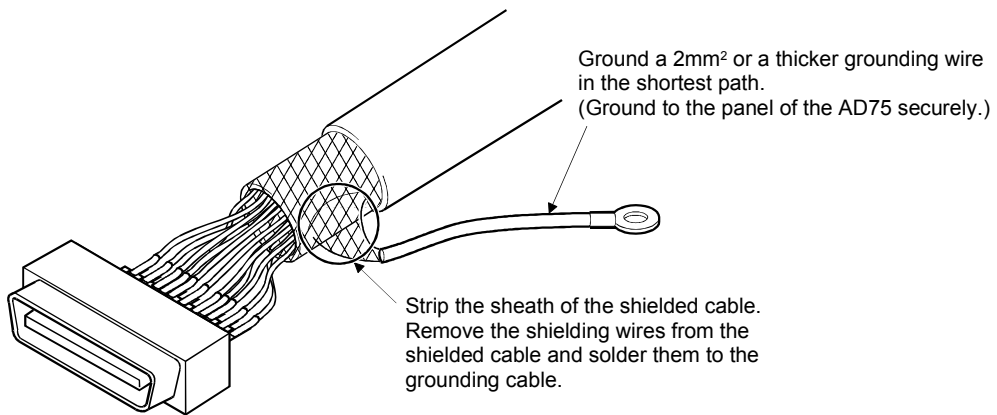

(11) To comply with EMC and low-voltage directives, use shielded cables and AD75CK cable clamp (made by Mitsubishi Electric) to ground to the panel.

1) When using cable of within 2m for wiring

- Ground the shield part of the external device connection cable with a cable clamp. (Ground the shield part at the point nearest to the external device connection connector of the A1SD75.)
- Wire the external device connection cable with the drive unit and external device at the shortest distance.
- Install the drive unit within the same enclosure.

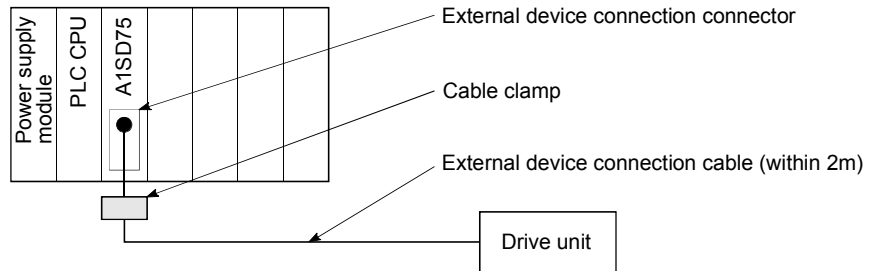

2) When using cable of more than 2m to within 10m for wiring

- Ground the shield part of the external device connection cable with a cable clamp. (Ground the shield part at the point nearest to the external device connection connector of the A1SD75.)
- Wire the external device connection cable with the drive unit and external device at the shortest distance.
- Fit a ferrite core.

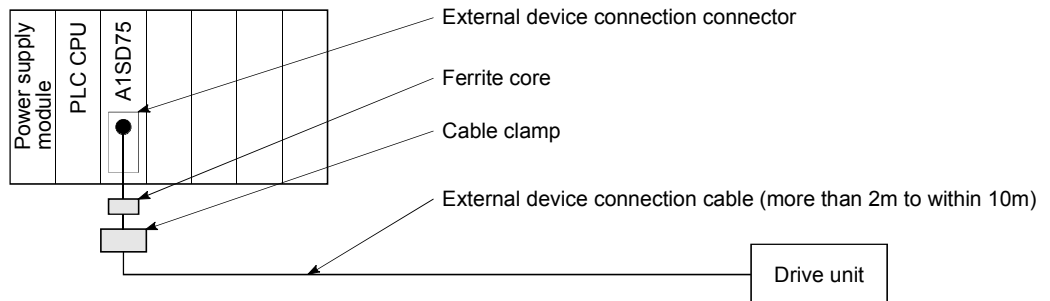

3) Ferrite core, cable clamp model names

- Cable clamp
Model name: AD75CK (Mitsubishi Electric make)
- Ferrite core
Model name: ZCAT3035-1330 (TDK make ferrite core)

Cable length	Product to be arranged	Required quantity		
		1 axis	2 axes	3 axes
Within 2m	AD75CK	1	1	1
More than 2m to within 10m	AD75CK	1	1	1
	ZCAT3035-1330	1	2	3

4) Cable clamp fitting position and shielded cable grounding method

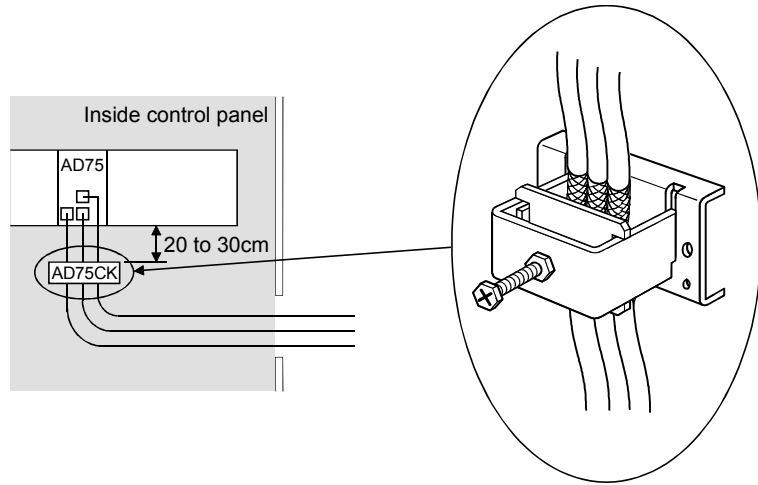

[How to ground shielded cable using AD75CK]

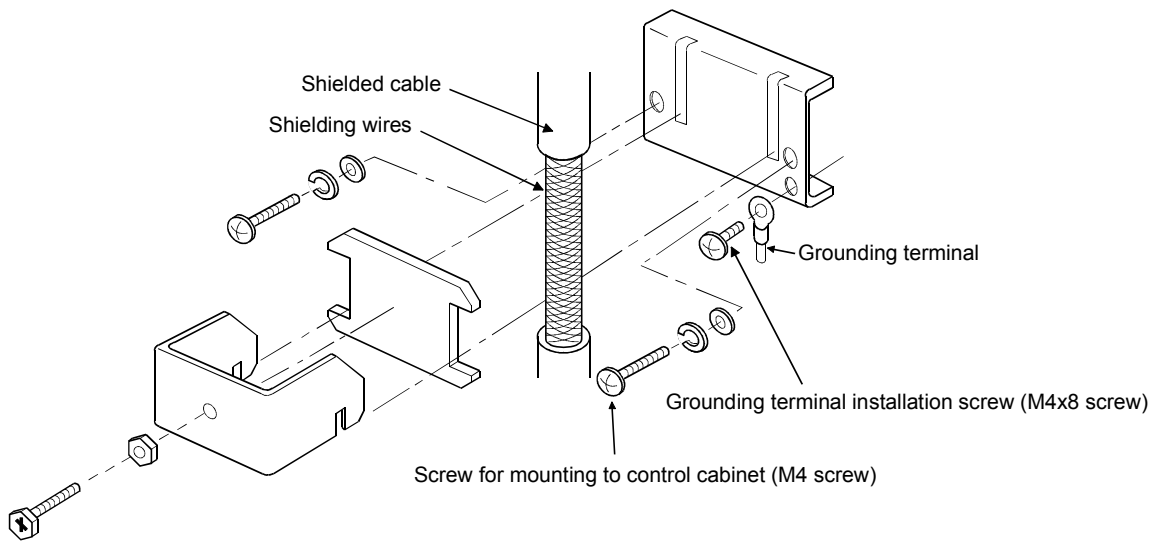

AD75CK can ground up to four shielded cables having about 7 mm or smaller outside diameters. (For details, refer to AD75CK cable clamp operation manual <IB-68682>.)

(Poor examples and improved examples are shown below.)

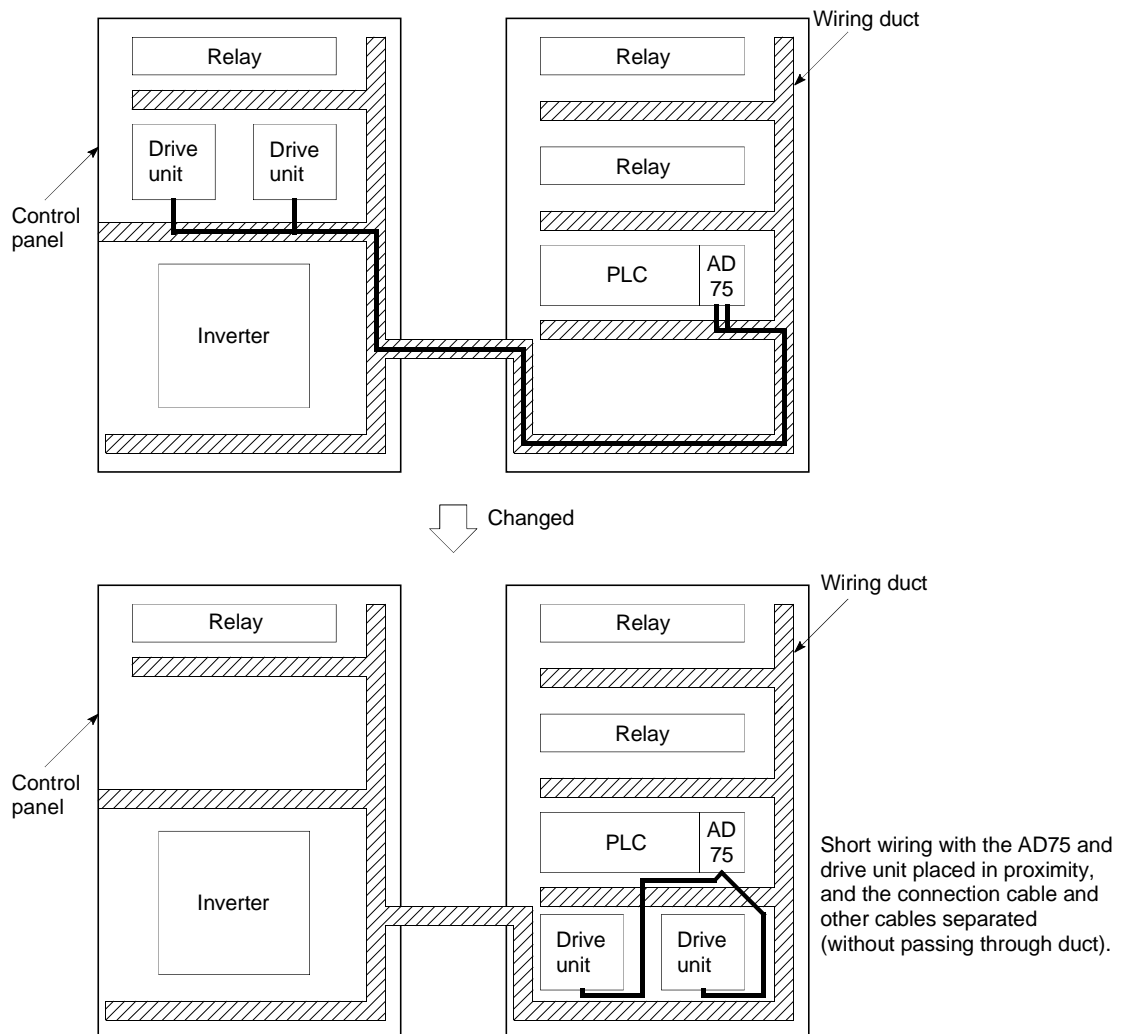

- (12) The influence of noise may be reduced by installing ferrite cores to the cable connected to the AD75 as a noise reduction technique.
For the noise reduction techniques related to connection with the servo amplifier, also refer to the instruction manual of the servo amplifier.
- (13) If compliance with the EMC directive is not required, the influence of external noise may be reduced by making the configuration compliant with the EMC directive.
For the configuration compliant with the EMC directive, refer to Chapter 3 "EMC directive and low voltage directive" in the User's Manual (Hardware) of the used CPU module.
- (14) Installing ferrite cores and noise filter to the power supply line of the PLC as noise reduction techniques may have effects on external noise.

(Example)

- Ferrite cores
Type: ZCAT3035-1330 (TDK ferrite core)
- Noise filter
Type: MXB-1210-33 (DENSEI-LAMBDA noise filter)

4.3.2 Wiring the external device connection connector pins

The pins for the external device connection connector are wired in the following manner.

- (1) Disassembling the connector section Disassemble the connector section, and remove the connector.
- ↓
- (2) Connecting the connector and wire Solder the wire onto the connector pin.
- ↓
- (3) Assembling the connector section Assemble the connector section.

(1) Disassembling the connector section

- (a) Loosen and remove screw A.
(Take care not to lose the screw and nut.)
- (b) Open the connector cover from the connector side.
- (c) Remove the connector and cable fixture.

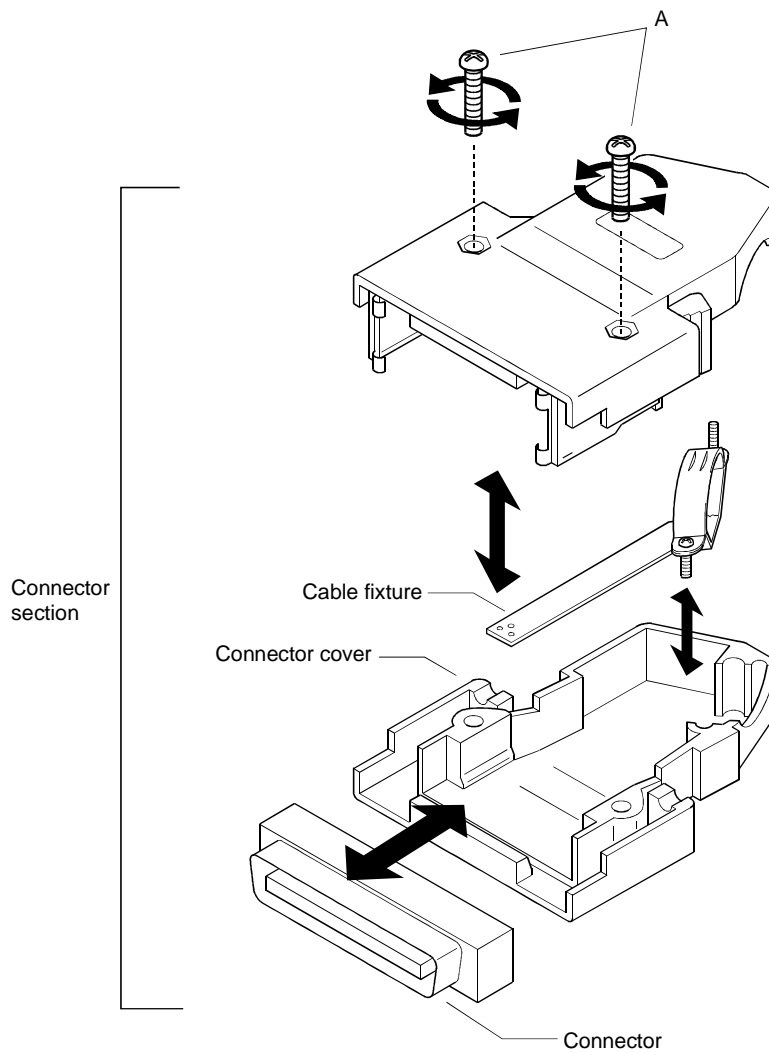

(2) Connecting the connector and wire

* Refer to section "3.5 Specifications of input/output interfaces with external devices" when connecting.

(a) Loosen the cable fixture screw B, pass the cable through, and then tighten screw B.

(Screw B may be removed once, and then tightened after sandwiching the cable.)

(Take care not to lose the screw and nut.)

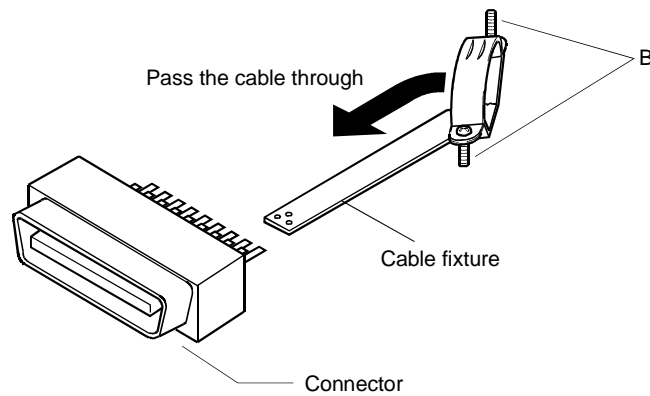

(b) Solder the wire onto the connector.

Connector pin layout

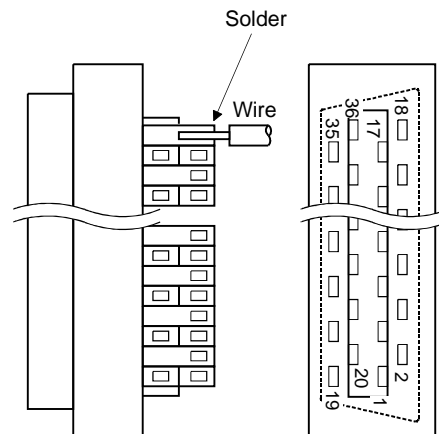

* The applicable size of the wire to be connected is "AWG#24 to #30 (approx. 0.05 to 0.2SQ)".

(c) After connection, the state will be as shown below.

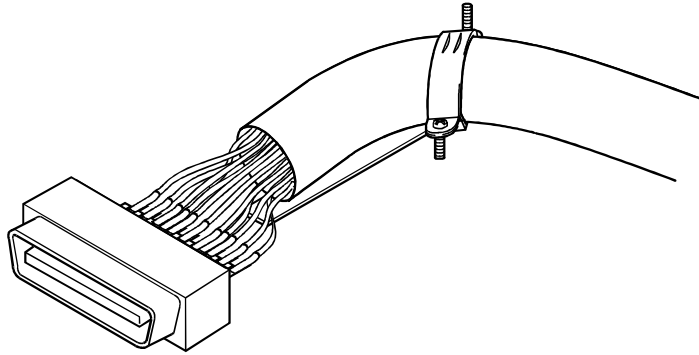

(3) Assembling the connector section

- (a) Fit the soldered connector and cable fixture into the connector cover.

* The cable fixture acts as a stopper to protect the signal wire connection section when the cable is pulled on. If the cable is not sufficiently tightened with the cable fixture, wind insulation tape around the cable so that it can be sufficiently tightened and pressed down.

- (b) Sandwich the parts with the connector cover, and tighten screw A.

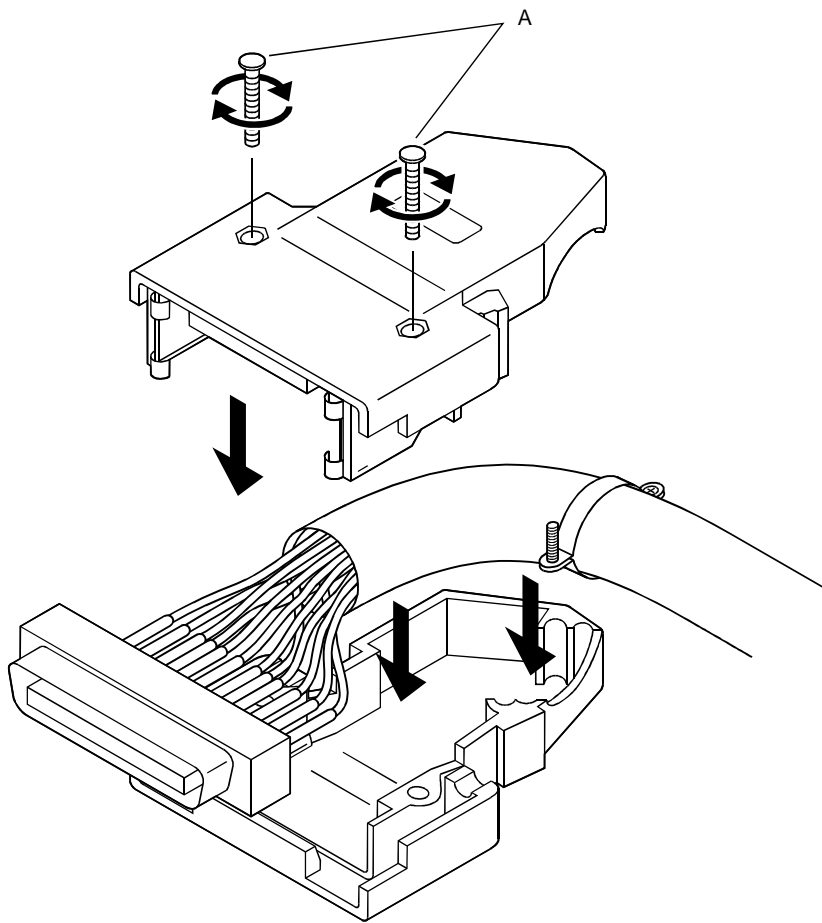

4.3.3 Connecting the connector

The AD75 is connected to the drive unit or peripheral device with the connector. Use the following procedure to connect.

(1) Connecting

- (a) Confirm that all phases of the externally supplied power used in the system are shut off.
* If not shut off, shut off all phases.
- (b) Confirm the module connector connection state and connector shape, and match the engagement orientation.
- (c) Press the connector straight into the module until a "click" is heard.

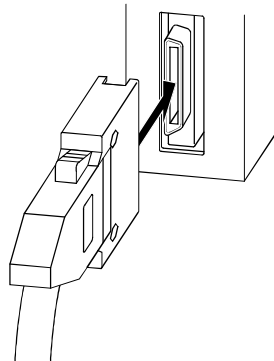

(2) Removing

- (a) Confirm that all phases of the externally supplied power used in the system are shut off.
* If not shut off, shut off all phases.
- (b) Press in the latches on both sides of the connector, and pull the connector straight off.

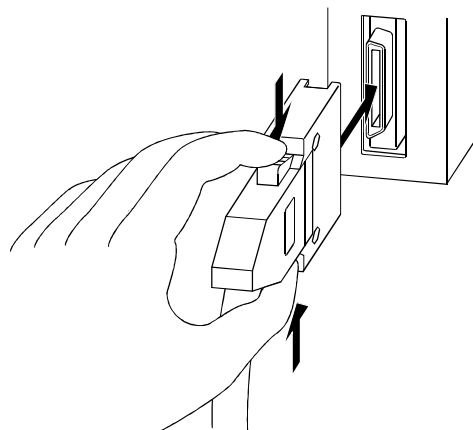

4.4 Confirming the installation and wiring

4.4.1 Items to confirm when installation and wiring are completed

Check the (1) and (2) points when completed with the AD75 installation and wiring.

(1) Does the AD75 operate correctly? ... "Single module test"

With the "single module test", correct operation of the AD75 is confirmed by the LED displays on the AD75. (Change the mode switch following the procedures given in section "4.4.2 Single module test", and confirm the details displayed on each mode LED.)

Check that there are no faults in the AD75 with the single module test.

(2) Is the module correctly wired? ... "Connection confirmation"

With "connection confirmation", the following three points are confirmed using the GX Configurator-AP's connection confirmation function. (The GX Configurator-AP is required for this "connection confirmation".)

- Are the AD75 and servo amplifier correctly connected?
- Are the servo amplifier and servomotor correctly connected?
- Are the AD75 and external device (input/output signal) correctly connected?

With this "connection confirmation", "whether the direction that the AD75 recognizes as forward run matches the address increment direction in the actual positioning work", and "whether the AD75 recognizes the external input/output signals such as the near-point dog signal and stop signal" can be checked.

In this manual (1) "Single module test" is explained. Refer to the GX Configurator-AP Operating Manual for details on (2) "Connection confirmation".

Important

<p>If the AD75 is faulty, or when the required signals such as the near-point dog signal and stop signal are not recognized, unexpected accidents such as "not decelerating at the near-point dog during machine zero point return and colliding with the stopper", or "not being able to stop with the stop signal" may occur.</p>

<p>The "single module test" and "connection confirmation" must be carried out not only when structuring the positioning system, but also when the system has been changed with module replacement or rewiring, etc.</p>

4.4.2 Single module test

Whether the AD75 is operating correctly is confirmed with the LED displays on the AD75 main body.

The "single module test" methods are described below.

The "single module test" can be carried out when there is no sequence program stored in the PLC CPU, when there is no data stored in the AD75, and when the AD75 is running.

Carry this test out after connecting the AD75, drive unit, motor and external devices. The "mode switch", "17-segment LED" and "axis display LED" used in the explanation refer to the AD75 switches and LEDs.

(Step 1) Turning ON the power

- 1) Stop the PLC CPU.
(When the AD75 is mounted on the remote station, stop the master station.)
- 2) Turn ON for the PLC CPU (when the AD75 is mounted on the remote station, the mounted station and master station), and the power for the drive unit and motor connected to the AD75.
- 3) The AD75 OS type [same displays as (Step 4)] will appear on the 17-segment LED for one second.
- 4) After one second passes, the state will shift to the operation monitor 1 described in (Step 2).

(Step 2) Operation monitor 1

- 1) Depending on the AD75 state, one of the following will appear on the 17-segment LED and axis display LED.

Confirm that the display matches the AD75 state.

AD75 state	17-segment LED	Each axis' axis display LED (AX1 to 3)
Running	RUN	The LED corresponding to the operating axis flickers.
In test mode	TEST	The LEDs of all axes turn ON.
Idle	IDL	OFF
Error occurrence	ERR	The LED corresponding to the axis in error flickers.

- 2) When the mode switch is pressed, the state will shift to the operation monitor 2 described in (Step 3).

(Step 3) Operation monitor 2

- 1) The axis display LED for each axis will turn ON sequentially at an approx. 0.5 second interval.
One of the following states will appear on the 17-segment LED to indicate the state of the axis for which the axis display LED is ON.
Confirm that the display matches each axis state.

Axis state	17-segment LED	Remarks
Idle	IDL	• State when power is turned ON/operation has ended.
Stopped	STOP	• State when positioning operation is temporarily stopped.
In JOG operation	JOG	-
In manual pulse generator operation	MANP	
In zero point return	OPR	
In position control	POSI	
In speed control	VELO	
In speed control for speed/position changeover control	V- P	
In position control for speed/position changeover control	V -P	
Waiting	BUSY	
Error occurrence *	E***	• The error code appears in ***. Refer to Chapter 14 for details on the errors.

POINT

* When the PLC READY signal [Y1D] is ON, even if a parameter error occurs, the error code will not appear on the 17-segment LED.
If the error code is not displayed on the 17-segment LED, check the error code with the peripheral device or AD75 error code storage buffer memory. (Md.33 Axis error No., Md.34 Axis warning No.)

- 2) When the mode switch is pressed, the state will shift to the internal information 1 monitor state described in (Step 4).

(Step 4) Internal information 1 monitor

- 1) The AD75 OS type ("S003") will appear on the 17-segment LED for reference.
- 2) The axis display LED for each axis will turn OFF.
- 3) When the mode switch is pressed, the state will shift to the internal information 2 monitor state described in (Step 5).

(Step 5) Internal information 2 monitor

- 1) The AD75 OS version will appear on the 17-segment LED for reference.

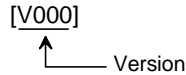

- 2) The axis display LED for each axis will turn OFF.
- 3) When the mode switch is pressed, the state will shift to the input/output information n monitor state described in (Step 6).

(Step 6) Input/output information n monitor

- 1) Each time the mode switch is pressed, the following input/output signal names will sequentially appear on the 17-segment LED.
- 2) The signal state of each axis displayed on the 17-segment LED is displayed with the axis display LED for each axis.

Confirm that the display matches each signal state.

- When signal is ON Axis display LED turns ON
- When signal is OFF Axis display LED turns OFF

17-segment LED	Target input/output signal name	Remarks
SVON	Drive unit READY signal	Changes sequentially with each press of the mode switch.
Z-ON	Zero point signal	
ULMT	Upper limit signal	
LLMT	Lower limit signal	
V-P	Speed/position changeover signal	
DOG	Near-point dog signal	

- 3) When the mode switch is pressed, the state will shift to the stepping motor mode monitor state described in (Step 7).

(Step 7) Stepping motor mode monitor

- 1) "STMM" will appear on the 17-segment LED.
- 2) The axis display LED corresponding to the axis set to the stepping motor mode will turn ON.

(Step 8) Shifting to operation monitor 1, and ending the operation monitor

- 1) When the mode switch is pressed, the state will return to the operation monitor 1 (Step 2).
 Each time the mode switch is then pressed, the operation monitors between (Step 2) and (Step 7) will be repeated.
- 2) To end the operation monitor, enter the monitor state between (Step 2) and (Step 7) required by the user.

POINT

- | |
|--|
| <p>(1) The operation monitor described in this section is a function that allows the AD75 state, control state of each axis and state of the input/output signals to be confirmed. This monitor can be operated at any time.</p> <p>(2) If the AD75 is not operating correctly, use the operation monitors as necessary.</p> <p>(3) As another display on the above 17-segment LED, if a watch dog timer error occurs in the AD75, "FALT" will appear.</p> <p>If a watch dog timer error occurs in the AD75, the PLC CPU must be reset.</p> <p>If the watch dog timer error still occurs in the AD75 even after resetting the PLC CPU, the AD75 module must be replaced.</p> <p>Contact your nearest dealer or sales office.</p> |
|--|

4.5 Maintenance

4.5.1 Precautions for maintenance

The precautions for servicing the AD75 are given below. Refer to this section as well as section "4.1.3 Handling precautions" when carrying out the work.

DANGER

- Switch off all phases of the externally supplied power used in the system before cleaning or tightening the screws.
Failure to turn all phases OFF could lead to electric shocks.

CAUTION

- Never disassemble or modify the module.
Failure to observe this could lead to trouble, malfunctioning, injuries or fires.
- Switch off all phases of the externally supplied power used in the system before installing or removing the module.
Failure to turn all phases OFF could lead to module trouble or malfunctioning.

4.5.2 Disposal instructions

CAUTION

- When disposing of the product, handle it as industrial waste.

MEMO

Chapter 5

DATA USED FOR POSITIONING CONTROL

The parameters and data used to carry out positioning control with the AD75 are explained in this chapter.

With the positioning system using the AD75, the various parameters and data explained in this chapter are used for control. The parameters and data include parameters set according to the device configuration, such as the system configuration, and parameters and data set according to each control. Read this section thoroughly and make settings according to each control or application.

* Refer to "SECTION 2" for details on each control.

5.1	Types of data	5-2
5.1.1	Parameters and data required for control	5-2
5.1.2	Setting items for positioning parameters.....	5-4
5.1.3	Setting items for zero point return parameters	5-6
5.1.4	Setting items for positioning data	5-7
5.1.5	Setting items for start block data	5-9
5.1.6	Setting items for condition data	5-10
5.1.7	Types and roles of monitor data.....	5-11
5.1.8	Types and roles of control data	5-14
5.2	List of parameters.....	5-18
5.2.1	Basic parameters 1	5-18
5.2.2	Basic parameters 2	5-24
5.2.3	Detailed parameters 1	5-28
5.2.4	Detailed parameters 2	5-36
5.2.5	Zero point return basic parameters	5-45
5.2.6	Zero point return detailed parameters.....	5-52
5.3	List of positioning data.....	5-56
5.4	List of start block data	5-71
5.5	List of condition data.....	5-77
5.6	List of monitor data	5-82
5.6.1	System monitor data.....	5-82
5.6.2	Axis monitor data	5-92
5.7	List of control data	5-106
5.7.1	System control data	5-106
5.7.2	Axis control data	5-112

5.1 Types of data

5.1.1 Parameters and data required for control

The parameters and data required to carry out control with the AD75 include the "setting data", "monitor data" and "control data" shown below.

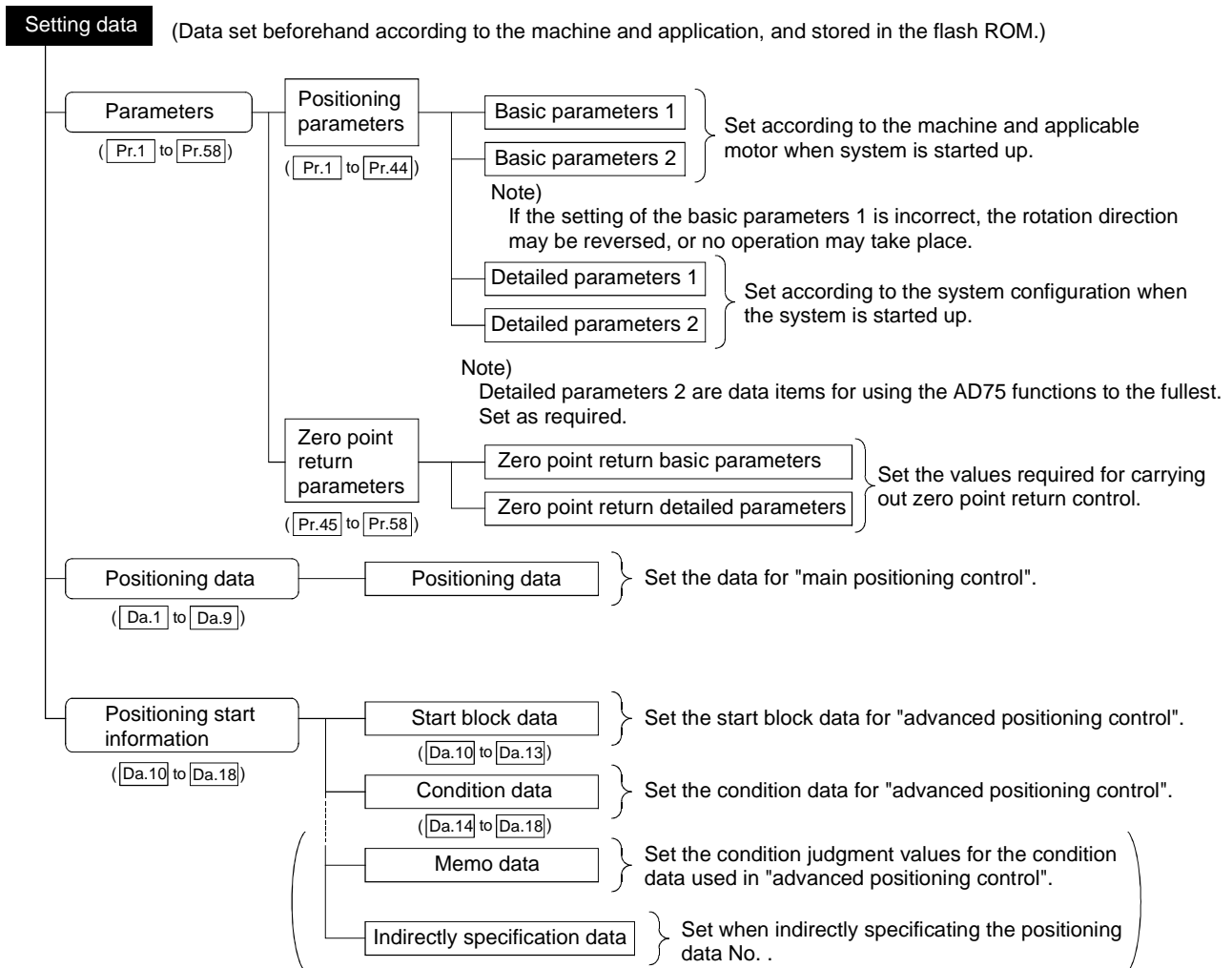

- ◇ The data is set with the sequence program or peripheral device.
In this chapter, the method using the peripheral device will be explained.
(Refer to "Point" on the next page.)
- ◇ The basic parameters 1, detailed parameters 1, and zero point return parameters become valid when the PLC READY signal [Y1D] turns from OFF to ON.
- ◇ The basic parameters 2 and detailed parameters 2 become valid immediately when they are written to the buffer memory, regardless of the state of the PLC READY signal [Y1D].
- ◇ Even when the PLC READY signal [Y1D] is ON, the values or contents of the following can be changed: basic parameters 2, detailed parameters 2, positioning data, and positioning start information.

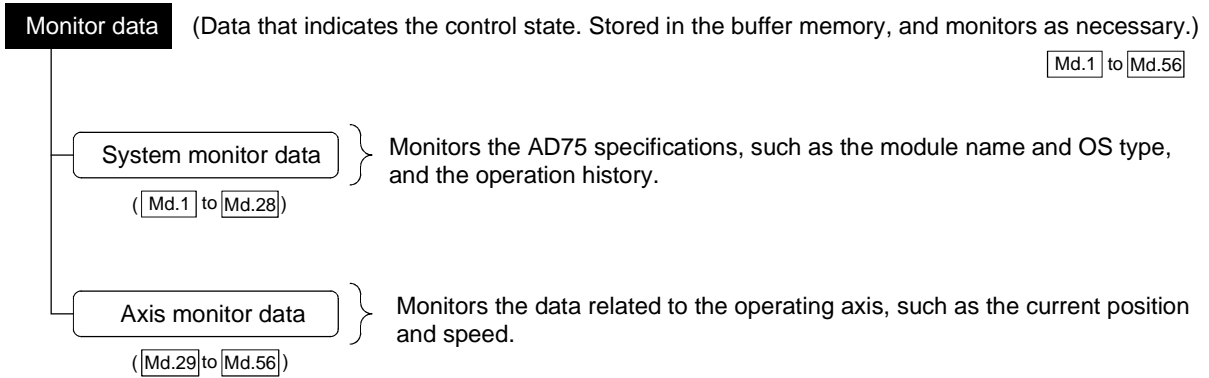

◇ The data is monitored with the sequence program or peripheral device. In this chapter, the method using the peripheral device will be explained.

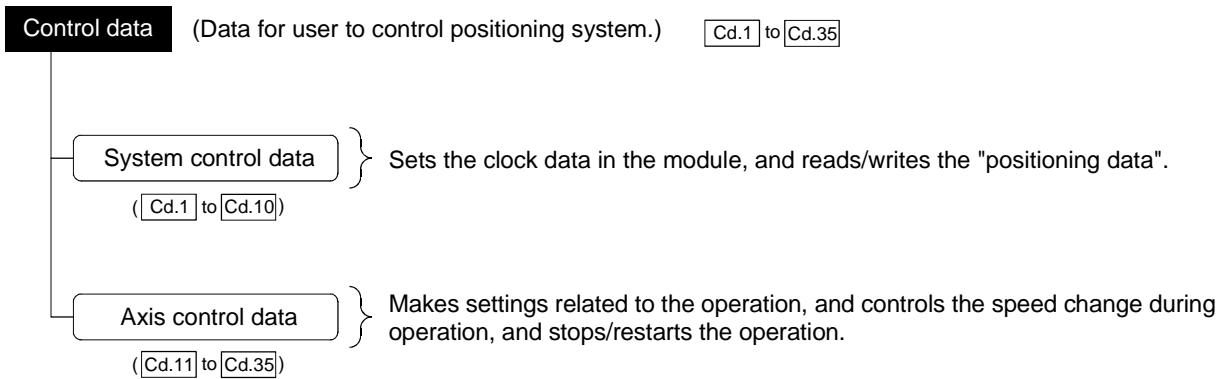

◇ Control using the control data is carried out with the sequence program.

POINT
(1) The "setting data" is created for each axis.
(2) The "setting data" parameters have determined default values, and are set to the default values before shipment from the factory. (Parameters related to axes that are not used are left at the default value.)
(3) The "setting data" can be initialized with the AD75 software package or the sequence program.
(4) It is recommended to set the "setting data" with the AD75 software package. When executed with the sequence program, many sequence programs and devices must be used. This will not only complicate the program, but will also increase the scan time.

5.1.2 Setting items for positioning parameters

The setting items for the "positioning parameters" are shown below. The "positioning parameters" are commonly set for each axis for all control using the AD75. Refer to "SECTION 2" for details on each control, and section "5.2 List of parameters" for details on each setting item.

Positioning parameter		Control	Main positioning control								Manual control		Related auxiliary function	
			Zero point return control	Position control				Speed control	Speed/position changeover control	Other control		Manual pulse generator operation		JOG operation
				1-axis linear control	2-axis linear interpolation control	1-axis fixed-dimension feed control	2-axis fixed-dimension feed control			2-axis circular interpolation control	Current value change			
Basic parameters 1	Pr.1	Unit setting	⊙	⊙	⊙	△	⊙	⊙	⊙	⊙	⊙	⊙	-	
	Pr.2	No. of pulses per rotation (Ap)	⊙	⊙	⊙	⊙	⊙	⊙	⊙	⊙	⊙	⊙	12.3.2*	
	Pr.3	Movement amount per rotation (Al)	⊙	⊙	⊙	⊙	⊙	⊙	⊙	⊙	⊙	⊙		
	Pr.4	Unit magnification (Am)	⊙	⊙	⊙	⊙	⊙	⊙	⊙	⊙	⊙	⊙		
	Pr.5	Pulse output mode	⊙	⊙	⊙	⊙	⊙	⊙	⊙	⊙	⊙	⊙	-	
	Pr.6	Rotation direction setting	⊙	⊙	⊙	⊙	⊙	⊙	⊙	⊙	⊙	⊙	-	
Basic parameters 2	Pr.7	Speed limit value	⊙	⊙	⊙	⊙	⊙	⊙	⊙	⊙	-	⊙	12.4.1*	
	Pr.8	Acceleration time 0	⊙	⊙	⊙	⊙	⊙	⊙	⊙	⊙	-	⊙	12.6.7*	
	Pr.9	Deceleration time 0	⊙	⊙	⊙	⊙	⊙	⊙	⊙	⊙	-	⊙		
	Pr.10	Bias speed at start	○	○	○	-	○	○	-	-	-	○	12.6.6*	
	Pr.11	Stepping motor mode selection	○	○	○	×	○	○	-	-	○	○		
Detailed parameters 1	Pr.12	Backlash compensation amount	○	○	○	○	○	○	-	-	○	○	12.3.1*	
	Pr.13	Software stroke limit upper limit value	-	○	○	○	○	○	-	-	○	○	12.4.3*	
	Pr.14	Software stroke limit lower limit value	-	○	○	○	○	○	-	-	○	○		
	Pr.15	Software stroke limit selection	-	○	○	○	○	○	-	-	○	○		
	Pr.16	Software stroke limit valid/invalid setting	-	-	-	-	-	-	○	○	○	○		
	Pr.17	Command in-position width	-	○	○	○	-	○	-	-	-	-	12.6.5*	
	Pr.18	Torque limit setting value	△	○	○	○	○	○	-	-	△	△	12.4.2*	
	Pr.19	M code ON signal output timing	-	○	○	○	○	○	-	-	-	-	12.6.3*	
	Pr.20	Speed changeover mode	-	○	○	○	-	-	-	-	-	-	-	
	Pr.21	Interpolation speed designation method	-	○	○	△	-	-	-	-	-	-	-	
	Pr.22	Current feed value during speed control	-	-	-	-	○	○	-	-	-	-	-	
	Pr.23	Manual pulse generator selection	-	-	-	-	-	-	-	-	⊙	-	-	
	Pr.24	Logic selection for pulse output to the drive unit	⊙	⊙	⊙	⊙	⊙	⊙	⊙	⊙	⊙	⊙	-	
Pr.25	Size selection for acceleration/deceleration time	○	△	△	△	△	△	-	-	-	△	-		

- ⊙ : Always set
- : Set as required ("-" when not set)
- ×
- △ : Setting limited
- : Setting not required (This is an irrelevant item, so the setting value will be ignored. If the value is the default value or within the setting range, there is no problem.)
- * : Section to be referred to

Positioning parameter		Control		Main positioning control							Manual control		Related auxiliary function	
				Position control				Speed control	Speed/position changeover control	Other control		Manual pulse generator operation		JOG operation
				Zero point return control	1-axis linear control 2-axis linear interpolation control	1-axis fixed-dimension feed control 2-axis fixed-dimension feed control	2-axis circular interpolation control			Current value change	JUMP command			
Detailed parameters 2	Pr.26	Acceleration time 1	○	○	○	○	○	○	-	-	-	○	12.6.7*	
	Pr.27	Acceleration time 2	○	○	○	○	○	○	-	-	-	○		
	Pr.28	Acceleration time 3	○	○	○	○	○	○	-	-	-	○		
	Pr.29	Deceleration time 1	○	○	○	○	○	○	-	-	-	○		
	Pr.30	Deceleration time 2	○	○	○	○	○	○	-	-	-	○		
	Pr.31	Deceleration time 3	○	○	○	○	○	○	-	-	-	○		
	Pr.32	JOG speed limit value	-	-	-	-	-	-	-	-	-	◎	12.4.1*	
	Pr.33	JOG operation acceleration time selection	-	-	-	-	-	-	-	-	-	◎	-	
	Pr.34	JOG operation deceleration time selection	-	-	-	-	-	-	-	-	-	◎	-	
	Pr.35	Acceleration/deceleration process selection	○	○	○	○	○	○	-	-	-	○	12.6.7*	
	Pr.36	S-curve ratio	○	○	○	○	○	○	-	-	-	○		
	Pr.37	Sudden stop deceleration time	○	○	○	○	○	○	-	-	-	○		
	Pr.38	Stop group 1 sudden stop selection	○	○	○	○	○	○	-	-	-	○		
	Pr.39	Stop group 2 sudden stop selection	○	○	○	○	○	○	-	-	-	○	-	
	Pr.40	Stop group 3 sudden stop selection	○	○	○	○	○	○	-	-	-	○	-	
	Pr.41	Positioning complete signal output time	-	○	○	○	○	○	○	-	-	-	-	
	Pr.42	Allowable circular interpolation error width	-	-	-	○	-	-	-	-	-	-	-	
	Pr.43	External start function selection	○	○	○	○	○	○	○	-	-	○	12.5.1* 12.6.2*	
Pr.44	Near pass mode selection for path control	-	○	-	○	-	-	-	-	-	-	12.3.3*		

◎ : Always set

○ : Set as required ("-" when not set)

- : Setting not required (This is an irrelevant item, so the setting value will be ignored. If the value is the default value or within the setting range, there is no problem.)

* : Section to be referred to

■ Checking the positioning parameters

Pr.1 to Pr.44 are checked with the following timing.

- (1) When the "PLC READY signal" output from the PLC CPU to the AD75 changes from OFF to ON
- (2) When the test mode using the AD75 software package

REMARK

- "Advanced positioning control" is carried out in combination with the "main positioning control". Refer to the "main positioning control" parameter settings for details on the parameters required for "advanced positioning control".

5.1.3 Setting items for zero point return parameters

When carrying out "zero point return control", the "zero point return parameters" must be set. The setting items for the "zero point return parameters" are shown below.

The "zero point return parameters" are set commonly for each axis.

Refer to "Chapter 8 ZERO POINT RETURN CONTROL" for details on the "zero point return control", and to section "5.2 List of parameters" for details on each setting item.

Zero point return control			Machine zero point return control						High-speed zero point return control
Zero point return parameters									
Zero point return basic parameters	Pr.45	Zero point return method	Near-point dog method	Stopper stop method 1)	Stopper stop method 2)	Stopper stop method 3)	Count method 1)	Count method 2)	Value set for machine zero point return control are used.
	Pr.46	Zero point return direction	◎	◎	◎	◎	◎	◎	
	Pr.47	Zero point address	◎	◎	◎	◎	◎	◎	
	Pr.48	Zero point return speed	◎	◎	◎	◎	◎	◎	
	Pr.49	Creep speed	◎	◎	◎	◎	◎	◎	
	Pr.50	Zero point return retry	R	R	R	-	R	R	
Zero point return detailed parameters	Pr.51	Zero point return dwell time	R	R	R	-	R	R	
	Pr.52	Setting for the movement amount after near-point dog ON	-	-	-	-	◎	◎	
	Pr.53	Zero point return acceleration time selection	◎	◎	◎	◎	◎	◎	
	Pr.54	Zero point return deceleration time selection	◎	◎	◎	◎	◎	◎	
	Pr.55	Zero point shift amount	S	S	S	S	S	S	
	Pr.56	Zero point return torque limit value	-	◎	◎	◎	-	-	
	Pr.57	Speed designation during zero point shift	S	S	S	S	S	S	
	Pr.58	Dwell time during zero point return retry	R	R	R	-	R	R	

◎ : Always set

- : Setting not required (This is an irrelevant item, so the setting value will be ignored. If the value is the default value or within the setting range, there is no problem.)

R : Set when using the section "12.2.1 Zero point return retry function". ("-" when not set.)

S : Set when using the section "12.2.2 Zero point shift function". ("-" when not set.)

■ Checking the zero point return parameters.

Pr.45 to Pr.58 are checked with the following timing.

- (1) When the "PLC READY signal" output from the PLC CPU to the AD75 changes from OFF to ON
- (2) When the test mode using the AD75 software package

5.1.4 Setting items for positioning data

The "positioning data" must be set when carrying out "main positioning control". The setting items for the "positioning data" are shown below.

One to 600 "positioning data" items can be set for each axis.

Refer to "Chapter 9 MAIN POSITIONING CONTROL" for details on the "main positioning control", and to section "5.3 List of positioning data" for details on each setting item.

Main positioning control			Position control			Speed control	Speed/position changeover control	Other control	
			1-axis linear control 2-axis linear interpolation control	1-axis fixed-dimension feed control 2-axis fixed-dimension feed control	2-axis circular interpolation control			Current value change	JUMP command
Positioning data setting items									
Da.1	Operation pattern	Independent positioning control	◎	◎	◎	◎	◎	◎	×
		Continuous positioning control	◎	◎	◎	×	◎	◎	◎
		Continuous path control	◎	×	◎	×	×	×	◎
Da.2	Control method	Linear 1 Linear 2 *	Fixed-dimension feed 1 Fixed-dimension feed 2 *	Circular interpolation Circular right Circular left *	Forward run Speed limited Reverse run Speed limited	Forward run speed/posi- tion Reverse run speed/posi- tion	Current value chang	JUMP command	
Da.3	Acceleration time No.	○	○	○	○	○	-	-	
Da.4	Deceleration time No.	○	○	○	○	○	-	-	
Da.5	Positioning address/movement amount	◎	◎	◎	-	-	Change destina- tion address	-	
Da.6	Arc address	-	-	◎	-	-	-	-	
Da.7	Command speed	◎	◎	◎	◎	◎	-	-	
Da.8	Dwell time/JUMP destination positioning data No.	○	○	○	○	○	-	JUMP destination positioning data No.	
Da.9	M code/condition data	○	○	○	○	○	-	Condition data No. when JUMP	

◎ : Always set

○ : Set as required ("-" when not set)

× : Setting not possible

- : Setting not required (This is an irrelevant item, so the setting value will be ignored. If the value is the default value or within the setting range, there is no problem.)

* : The "ABS (absolute) method" or "INC (incremental) method" can be used for the control method.

■ Checking the positioning data

Da.1 to Da.9 are checked with the following timing.

- (1) Startup of a positioning operation
- (2) When the test mode using the AD75 software package

5.1.5 Setting items for start block data

The "start block data" must be set when carrying out "advanced positioning control".

The setting items for the "start block data" are shown below.

Up to 50 points of "start block data" can be set for each axis.

Refer to "Chapter 10 ADVANCED POSITIONING CONTROL" for details on the "advanced positioning control", and to section "5.4 List of start block data" for details on each setting item.

Advanced positioning control Start block data setting items		Block start (Normal start)	Condition start	Wait start	Simultaneous start	Stop	Repeated start (FOR loop)	Repeated start (FOR condition)
Da.10	Shape	○	○	○	○	○	○	○
Da.11	Start data No.	○	○	○	○	○	○	○
Da.12	Special start command	—	○	○	○	○	○	○
Da.13	Parameter	—	○	○	○	—	○	○

○ : Set as required ("—" when not set)

— : Setting not required (This is an irrelevant item, so the setting value will be ignored. If the value is the default value or within the setting range, there is no problem.)

■ Checking the start block data

Da.10 to Da.13 are checked with the following timing.

- (1) When the "Start block data" starts
- (2) When the test mode using the AD75 software package

5.1.6 Setting items for condition data

When carrying out "advanced positioning control" or using the JUMP command in the "main positioning control", the "condition data" must be set as required. The setting items for the "condition data" are shown below.

Up to 10 "condition data" items can be set for each axis.

Refer to "Chapter 10 ADVANCED POSITIONING CONTROL" for details on the "advanced positioning control", and to section "5.5 List of condition data" for details on each setting item.

Control		Main positioning control		Advanced positioning control						
		Other than JUMP command	JUMP command	Block start (Normal start)	Condition start	Wait start	Simultaneous start	Stop	Repeated start (FOR loop)	Repeated start (FOR condition)
Condition data										
Da.14	Condition target	-	○	-	○	○	○	-	-	○
Da.15	Condition operator	-	○	-	○	○	○	-	-	○
Da.16	Address	-	△	-	△	△	-	-	-	△
Da.17	Parameter 1	-	○	-	○	○	△	-	-	○
Da.18	Parameter 2	-	△	-	△	△	△	-	-	△

○ : Set as required ("-" when not set)

△ : Setting limited

- : Setting not required (This is an irrelevant item, so the setting value will be ignored. If the value is the default value or within the setting range, there is no problem.)

■ Checking the condition data

Da.14 to Da.18 are checked with the following timing.

- (1) When the "Start block data" starts
- (2) When "JUMP command" starts
- (3) When the test mode using the AD75 software package

5.1.7 Types and roles of monitor data

Data that indicates the positioning system's operation state is stored in the buffer memory's monitor data area.

When using the positioning system, this data must be monitored as necessary.

The data that can be monitored is shown below.

- Monitoring the system

Monitors the AD75 specifications, such as the module name and OS type, and the operation history. (System monitor data Md.1 to Md.28)

- Monitoring the axis operation state

Monitors the data related to the operating axis, such as the current position and speed. (Axis monitor data Md.29 to Md.56)

* The axis monitor data is updated every 56.8ms. Note that "Md.32 Valid M code" is updated simultaneously when "M code ON signal [XD, XE, XF] turns ON.

(1) Monitoring the system

■ Monitoring the AD75 specifications

Monitor details	Corresponding item
Monitor the module name	Md.2 Module name
Monitor the OS type	Md.3 OS type
Monitor the OS version	Md.4 OS version
Monitor the clock data used in the system	Md.5 Clock data (Hour: minute)
	Md.6 Clock data (Second: 100ms)

■ Monitoring the positioning system operation history

Monitor details		Corresponding item		
Monitor whether the system is in the test mode		Md.1	In test mode flag	
Monitor the history of the data that has been started	Start axis	Md.7	Start axis	
	Operation type	Md.8	Operation type	
	Start	Hour : minute	Md.9	Start time (Hour: minute)
		Second : 100ms	Md.10	Start time (Second: 100 ms)
	Error when starting	Md.11	Error judgment	
	Latest pointer No.	Md.12	Starting history pointer	
Monitor the history of the data that caused an error when starting and that was not operated	Start axis	Md.13	Start axis	
	Operation type	Md.14	Operation type	
	Start	Hour : minute	Md.15	Start time (Hour: minute)
		Second : 100ms	Md.16	Start time (Second: 100 ms)
	Error when starting	Md.17	Error judgment	
	Latest pointer No.	Md.18	Starting history pointer at error	
Monitor the history of all errors	Axis in which the error occurred	Md.19	Axis in which the error occurred	
	Axis error No.	Md.20	Axis error No.	
	Axis error occurrence	Hour : minute	Md.21	Axis error occurrence time (Hour: minute)
		Second : 100ms	Md.22	Axis error occurrence time (Second: 100ms)
	Latest pointer No.	Md.23	Error history pointer	
Monitor the history of all warnings	Axis in which the warning occurred	Md.24	Axis in which the warning occurred	
	Axis warning No.	Md.25	Axis warning No.	
	Axis warning occurrence	Hour : minute	Md.26	Axis warning occurrence time (Hour: minute)
		Second : 100ms	Md.27	Axis warning occurrence time (Second: 100ms)
	Latest pointer No.	Md.28	Warning history pointer	

(2) Monitoring the axis operation state

■ Monitoring the position

Monitor details	Corresponding item	
Monitor the current machine feed value	Md.30	Machine feed value
Monitor the current "current feed value"	Md.29	Current feed value
Monitor the current target value	Md.41	Target value

■ Monitoring the speed

Monitor details			Corresponding item
Monitor the current speed	During independent axis control		Indicates the speed of each axis
	During interpolation control	When "0: Composite speed" is set for "[Pr.21] Interpolation speed designation method"	Indicates the composite speed
		When "1: Reference axis speed" is set for "[Pr.21] Interpolation speed designation method"	Indicates the reference axis speed
	Constantly indicates the speed of each axis		
Monitor the current target speed			[Md.42] Target speed

■ Monitoring the state

Monitor details	Corresponding item
Monitor the axis operation state	[Md.35] Axis operation status
Monitor the latest error code that occurred with the axis	[Md.33] Axis error No.
Monitor the latest warning code that occurred with the axis	[Md.34] Axis warning No.
Monitor the external input/output signal and flag	[Md.39] External input/output signal [Md.40] Status
Monitor the valid M codes	[Md.32] Valid M code
Monitor whether the speed is being limited	[Md.49] In speed limit flag
Monitor whether the speed is being changed	[Md.50] In speed change processing flag
Monitor the "start information" point currently being executed	[Md.51] Start data pointer being executed
Monitor the "positioning data No." currently being executed	[Md.54] Positioning data No. being executed
Monitor the remaining No. of repetitions	[Md.53] Repeat counter
Monitor the block positioning No.	[Md.55] Block No. being executed
Monitor the zero point absolute position	[Md.43] Zero point absolute position
Monitor the current torque limit value	[Md.45] Torque limit stored value
Monitor the "command code" of the special start data when using special start	[Md.46] Special start data command code setting value
Monitor the "command parameter" of the special start data when using special start	[Md.47] Special start data command parameter setting value
Monitor the "start data No." of the special start data when using special start	[Md.48] Start positioning data No. setting value
Monitor the "positioning data No." executed last	[Md.52] Last executed positioning data No.
Monitor the positioning data currently being executed	[Md.56] Positioning data being executed
Monitor the movement amount after the current position control changeover when using "speed/position changeover control"	[Md.38] Speed/position changeover control positioning amount

5.1.8 Types and roles of control data

Several controls are carried out as necessary when using the positioning system. (When the power is turned ON, the default values of the data used for control are set. However, these values can be set with the sequence program when necessary.) The items that can be controlled are shown below.

- Controlling the system data

Sets the clock data in the AD75, and reads/writes the "positioning data". (System control data [Cd.1] to [Cd.10])

- Controlling the operation

Makes settings related to the operation, and controls the speed change during operation, and stops/restarts the operation. (Axis control data [Cd.11] to [Cd.32])

(1) Controlling the system data

■ Setting the AD75 clock data

Control details	Corresponding item
Set the item (hour)	[Cd.1] Clock data setting (hour)
Set the item (minute, second)	[Cd.2] Clock data setting (minute, second)
Write the data set in [Cd.1] and [Cd.2] into the AD75	[Cd.3] Clock data writing

■ Reading/writing the positioning data

Control details	Corresponding item
Set the "axis" in which the positioning data subject to reading or writing is set	[Cd.4] Target axis
Set the "positioning data No." subject to reading or writing	[Cd.5] Positioning data No.
When writing the data, designate which "positioning data" that has been read in to write	[Cd.6] Write pattern
Request writing or reading	[Cd.7] Read/write request
Temporarily store the read data * This buffer memory is used as the storage area.	[Cd.8] Read/write positioning data I/F
Write the data in the OS area to the flash ROM	[Cd.9] Flash ROM write request
Initialize the parameters	[Cd.10] Parameter initialization request

[Reference]

The outline of reading and writing the positioning data is shown below.

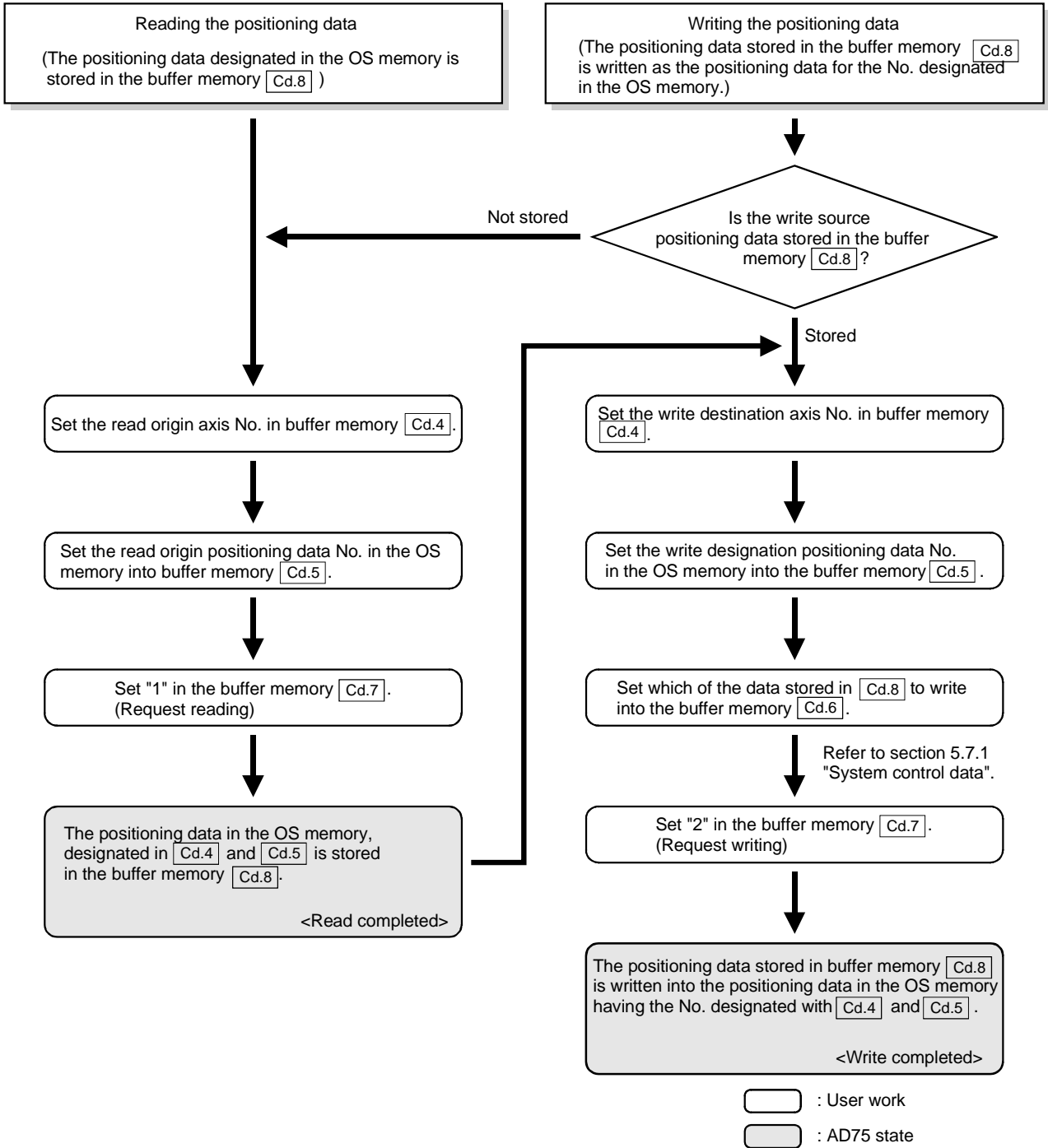

(2) Controlling the operation

■ Controlling the operation

Control details	Corresponding item
Set which positioning to execute (start No.)	Cd.11 Positioning start No.
Clear (reset) the axis error No. (Md.33) and axis warning No. (Md.34)	Cd.12 Axis error reset
Issue instruction to restart (When axis operation is stopped)	Cd.13 Restart command
End current positioning (deceleration stop), and start next positioning	Cd.29 Skip command
Set start point No. for executing block start	Cd.31 Positioning starting point No.
Stop continuous control	Cd.32 Interrupt request during continuous operation

■ Controlling operation per step

Control details	Corresponding item
Stop positioning operation after each operation	Cd.26 Step valid flag
Set unit to carry out step	Cd.27 Step mode
Issue instruction to continuous operation or restart from stopped step	Cd.28 Step start information

■ Controlling the speed

Control details	Corresponding item
Set new speed when changing speed during operation	Cd.16 New speed value
Issue instruction to change speed in operation to Cd.16 value. (Only during positioning operation and JOG operation)	Cd.17 Speed change request
Change positioning operation speed between 1 and 300% range	Cd.18 Positioning operation speed override
Set JOG speed	Cd.19 JOG speed
When changing acceleration time during speed change, set new acceleration time	Cd.33 New acceleration time value
When changing deceleration time during speed change, set new deceleration time	Cd.34 New deceleration time value
Set acceleration/deceleration time validity during speed change	Cd.35 Acceleration/deceleration time change during speed change, enable/disable selection

■ Making settings related to operation

Control details	Corresponding item
Turn M code ON signal OFF	Cd.14 M code OFF request
Set new value when changing current value	Cd.15 New current value
Validate speed/position changeover signal from external source	Cd.20 Speed/position changeover enable flag
Change movement amount for position control during speed/position changeover control	Cd.21 Speed/position changeover control movement amount change register
Set manual pulse generator operation validity	Cd.22 Manual pulse generator enable flag
Set scale per pulse of No. of input pulses from manual pulse generator	Cd.23 Manual pulse generator 1 pulse input magnification
Change zero point return request flag from "ON to OFF"	Cd.24 Zero point return request flag OFF request
Validate external start signal	Cd.25 External start valid
Change "[Md.45] Torque limit stored value"	Cd.30 New torque value

5.2 List of parameters

5.2.1 Basic parameters 1

Item	Setting value, setting range		Default value	Setting value buffer memory address							
	Value set with peripheral device	Value set with sequence program		Axis 1	Axis 2	Axis 3					
Pr.1 Unit setting	0 : mm	0	3	0	150	300					
	1 : inch	1									
	2 : degree	2									
	3 : pulse	3									
Movement amount per pulse	Pr.2 No. of pulses per rotation (Ap) (Unit : pulse) 1 to 65535	1 to 65535	20000	1	151	301					
		1 to 32767: Set as a decimal									
		32768 to 65535: Convert into hexadecimal and set									
Pr.3 Movement amount per rotation (Al)	The setting value range differs according to the "Pr.1 Unit setting". Here, the value within the [Table 1] range is set.		20000	2	152	302					
											
	Pr.4 Unit magnification (Am)	1 : 1-fold					1	1	3	153	303
		10 : 10-fold					10				
100 : 100-fold		100									
1000 : 1000-fold		1000									

Pr.1 Unit setting

This sets the command unit for positioning control. The unit is selected from mm, inch, degree, pulse according to the control target. The unit for axis 1, axis 2 and axis 3 can be set independently.

(Example)

mm, inch..... X, Y table, conveyor. (If the machine has inch specifications, set with an inch unit.)

degree Rotating body. (360 degree/rotation)

pulse..... X, Y table, conveyor

* Even if the unit setting is changed, the other parameters and positioning data values will not change. When changing the unit, check that the parameters and data are within the setting range.

Pr.2 to **Pr.4** Movement amount per pulse

Set the movement amount per pulse count when outputting a pulse train from the AD75. The setting is made with **Pr.2** to **Pr.4**. (The case for the "**Pr.1** Unit setting" is "mm" is explained below.)

The movement amount per pulse is expressed with the following expression.

$$\text{Movement amount per pulse} = \frac{\text{Movement amount per rotation (Al)}}{\text{No. of pulses per rotation (Ap)}}$$

* When carrying out positioning, an error (mechanical error) could occur between the designated movement amount and actual movement amount. In that case, the error can be compensated with the "movement amount per pulse". (Refer to section "12.3.2 Electronic gear function".)

POINT
<p>If the movement amount per pulse is less than 1, command frequency variations will occur. Smaller setting will increase variations and may cause machine vibration. If the movement amount per pulse becomes less than 1, also use the electronic gear function of the drive unit and make setting so that the movement amount per pulse is 1 or greater.</p>

Pr.

Pr.2 No. of pulses per rotation (Ap)

Set the No. of pulses required for the motor shaft to rotate once. When using the Mitsubishi servo amplifier MR-H, MR-J2/J2S* or MR-C, set the "resolution per servomotor rotation" given in the speed/position detector specifications.

$$\text{No. of pulses per rotation (Ap)} = \text{Resolution per servomotor rotation}$$

*: Since the "resolution per servomotor revolution" of our servo amplifier MR-J2S exceeds 65535 pulses, make setting after referring to the Servo Amplifier Instruction Manual.

[Table 1]

Pr.1 setting value	Value set with peripheral device (unit)	Value set with sequence program (unit) *
0 : mm	0.1 to 6553.5 (μm)	1 to 65535 (× 10 ⁻¹ μm)
1 : inch	0.0001 to 0.65535 (inch)	1 to 65535 (× 10 ⁻⁵ inch)
2 : degree	0.00001 to 0.65535 (degree)	1 to 65535 (× 10 ⁻⁵ degree)
3 : pulse	1 to 65535 (pulse)	1 to 65535 (pulse)

* 1 to 32767 : Set as a decimal
32768 to 65535 : Convert into hexadecimal and set

Pr.3 Movement amount per rotation (Al), **Pr.4** Unit magnification (Am)

The amount how the workpiece moves with one motor rotation is determined by the mechanical structure.

If the worm gear lead (mm/rev) is PB and the deceleration rate is 1/n, then

$$\text{Movement amount per rotation (AL)} = PB \times 1/n$$

However, the maximum value that can be set for this "movement amount per rotation (Al)" parameter is 6553.5µm (approx. 6.5mm). Set the "movement amount per rotation (Al)" as shown below so that the "movement amount per rotation (AL)" does not exceed this maximum value.

$$\begin{aligned} \text{Movement amount per rotation (AL)} &= PB \times 1/n \\ &= \text{Movement amount per rotation (Al)} \times \text{Unit magnification (Am)} \end{aligned}$$

Note) The unit magnification (Am) is a value of 1, 10, 100 or 1000. If the "PB × 1/n" value exceeds 6553.5 µm, adjust with the unit magnification so that the "movement amount per rotation (Al)" does not exceed 6553.5 µm.

Example 1)

When movement amount per rotation (AL) = PB × 1/n = 6000.0µm (= 6mm)

$$\begin{aligned} \text{Movement amount per rotation (AL)} &= \text{Movement amount per rotation (Al)} \times \text{Unit magnification (Am)} \\ &= 6000.0\mu\text{m} \times 1 \end{aligned}$$

Example 2)

When movement amount per rotation (AL) = PB × 1/n = 60000.0µm (= 60mm)

$$\begin{aligned} \text{Movement amount per rotation (AL)} &= \text{Movement amount per rotation (Al)} \times \text{Unit magnification (Am)} \\ &= 6000.0\mu\text{m} \times 10 \\ &= 600.0\mu\text{m} \times 100 \end{aligned}$$

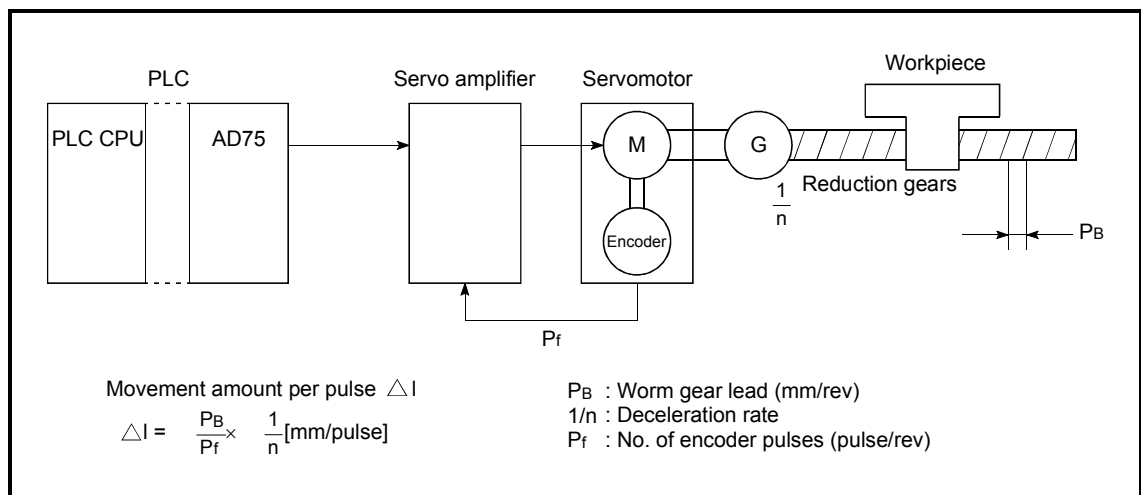

Item	Setting value, setting range		Default value	Setting value buffer memory address		
	Value set with peripheral device	Value set with sequence program		Axis 1	Axis 2	Axis 3
Pr.5 Pulse output mode	0: PULSE/SIGN mode	0	1	4	154	304
	1: CW/CCW mode	1				
	2: A phase/B phase (multiple of 4)	2				
	3: A phase/B phase (multiple of 1)	3				
Pr.6 Rotation direction setting	0: Current value increment with forward run pulse output	0	0	5	155	305
	1: Current value increment with reverse run pulse output	1				

Pr.5 Pulse output mode

Set the pulse output mode to match the servo amplifier being used.
 The pulse positive logic and negative logic is changed with "Pr.24 Logic selection for pulse output to the drive unit".
 An example of the pulse output mode for positive logic is shown below.

(1) PULSE/SIGN mode

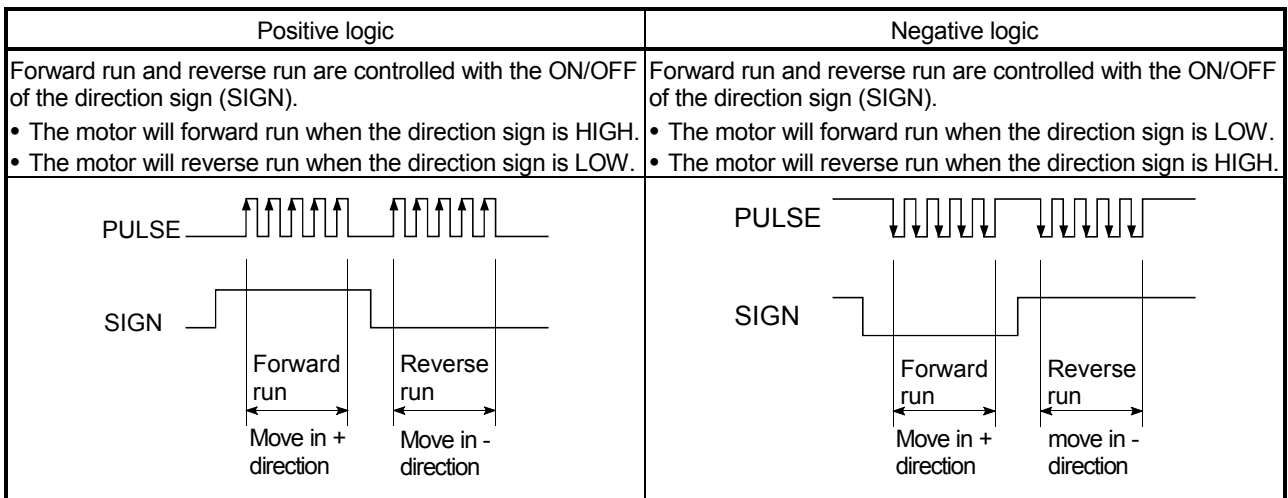

(2) CW/CCW mode

During forward run, the forward run feed pulse (PULSE F) will be output.
 During reverse run, the reverse run feed pulse (PULSE R) will be output.

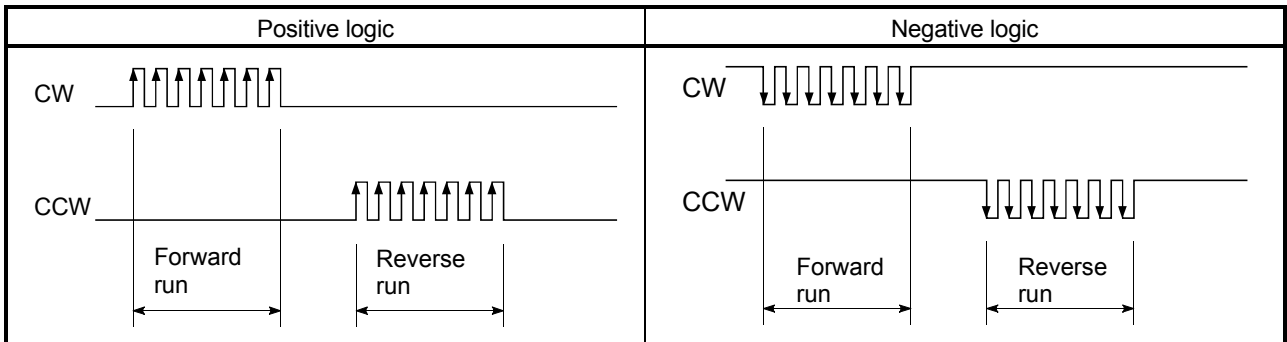

(3) A phase/B phase mode

Forward run and reverse run are controlled with the phase difference of the A phase (A) and B phase (B).

- When the B phase is 90° behind the A phase, the motor will forward run.
- When the B phase is 90° ahead of the A phase, the motor will reverse run.

The AD75 defines a waveform having four edges (rising/falling) in one command pulse as "multiple of 4", and one having a single edge (rising/falling) in one command pulse as "multiple of 1".

(a) For multiple of 1 setting

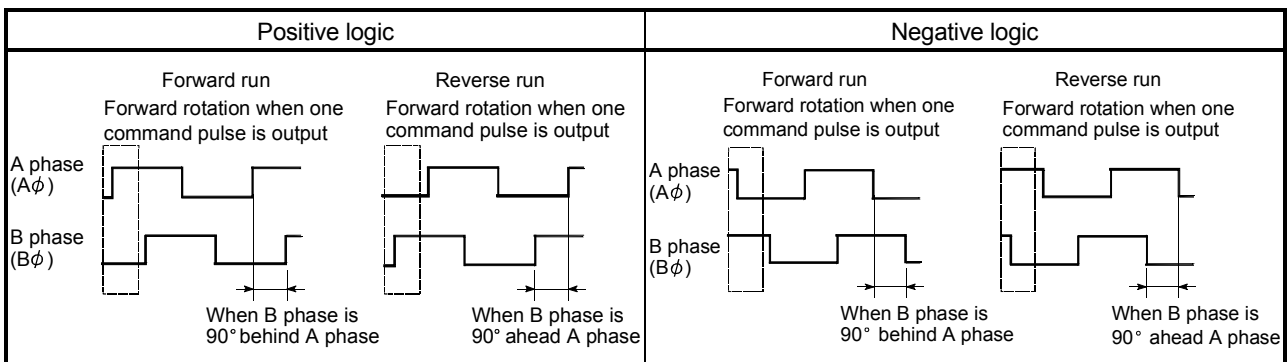

Example) When one command pulse is output at 1 pulse/s, rising and falling occur once per second.

(b) For multiple of 4 setting

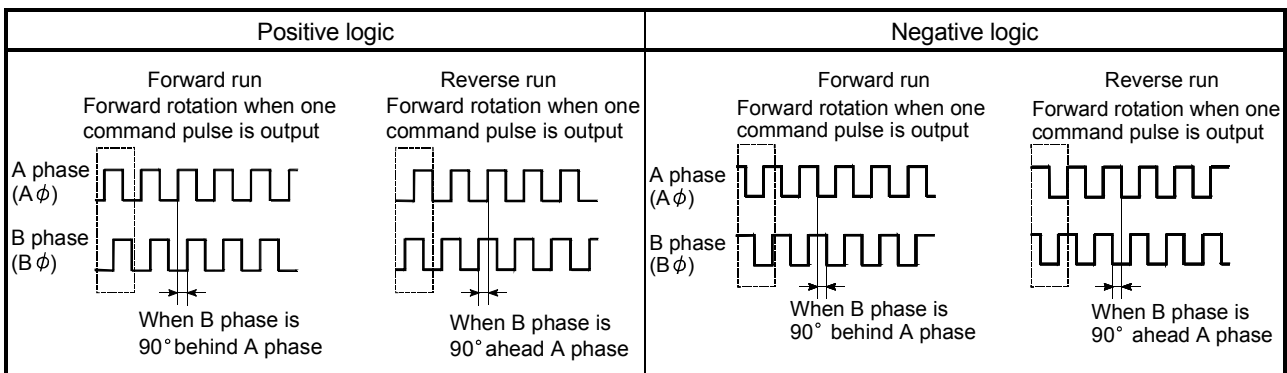

Example) When one command pulse is output at 1 pulse/s, rising and falling occur four times per second.

Pr.6 Rotation direction setting

Set the relation of the motor rotation direction and current value address increment/decrement.

[Setting procedure]

- 1) Set "0" in **Pr.6**, and carry out forward run JOG operation.
("0" is set as the default value for **Pr.6**.)
- 2) When the workpiece "W" is moving toward the address increment direction defined in the system the address increment direction, the current setting is O.K.
When the workpiece "W" is moving toward the address decrement direction defined in the system the address decrement direction, set "1" in **Pr.6**, and change the rotative direction.
- 3) Carry out forward run JOG operation again, and if "W" moves toward the increment direction, the setting is complete.

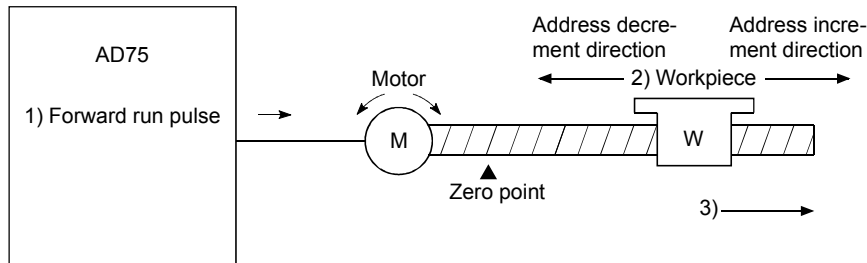
**POINT**

When **Pr.6** has been changed from "0" to "1", check if the upper and lower limit switches operate properly by JOG operation.

If any malfunction is identified, check and correct the wiring.

5.2.2 Basic parameters 2

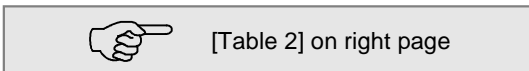
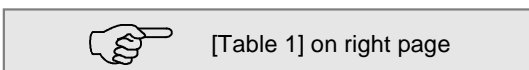
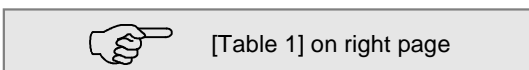
Item	Setting value, setting range		Default value	Setting value buffer memory address		
	Value set with peripheral device	Value set with sequence program		Axis 1	Axis 2	Axis 3
Pr.7 Speed limit value	The setting value range differs depending on the "Pr.11 Stepping motor mode selection" or "Pr.1 Unit setting". Here, the value within the [Table 1] range is set.  [Table 1] on right page		200000	6 7	156 157	306 307
Pr.8 Acceleration time 0	The setting value range differs according to the "Pr.25 Size selection for acceleration/deceleration time setting". Here, the value within the [Table 2] range is set.  [Table 2] on right page		1000	8 9	158 159	308 309
Pr.9 Deceleration time 0	The setting value range differs depending on the "Pr.11 Stepping motor mode selection" or "Pr.1 Unit setting". Here, the value within the [Table 1] range is set.  [Table 1] on right page		1000	10 11	160 161	310 311
Pr.10 Bias speed at start	The setting value range differs depending on the "Pr.11 Stepping motor mode selection" or "Pr.1 Unit setting". Here, the value within the [Table 1] range is set.  [Table 1] on right page		0	12 13	162 163	312 313
Pr.11 Stepping motor mode selection	0: Standard mode	0	0	14	164	314
	1: Stepping motor mode	1				

Pr.7 Speed limit value

Set the maximum speed for zero point return control and positioning control. The speed during positioning control must be limited according to the drive unit and control target. The speed limit conditions follow the following:

- 1) Motor speed
- 2) Workpiece movement speed

Pr.8 Acceleration time 0, Pr.9 Deceleration time 0

Set the item to reach "Pr.7 Speed limit value" from speed 0.

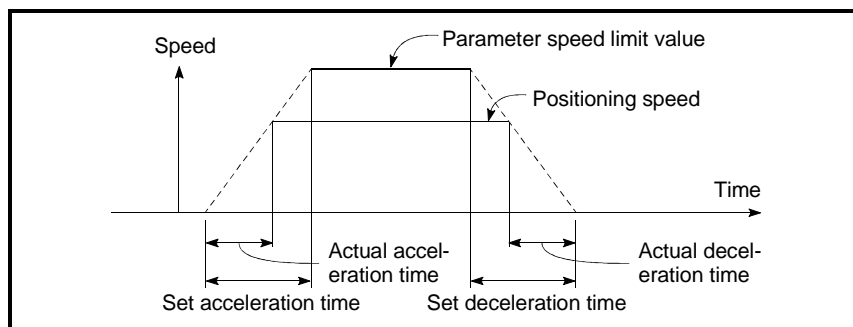

- 1) If the positioning speed setting is slower than the parameter speed limit, the actual acceleration/deceleration time will be relatively short. Thus, set the maximum positioning speed value to be equal to the parameter speed limit value or a close value under the speed limit value.
- 2) These settings are value for zero point return, positioning and JOG operation.
- 3) During interpolation positioning, the acceleration/deceleration item for the reference axis is valid.

[Table 1]

Pr.11 setting value	Pr.1 setting value	Value set with peripheral device (unit)	Value set with sequence program (unit)
0 : Standard mode	0 : mm	0.01 to 6000000.00 (mm/min)	1 to 600000000 ($\times 10^{-2}$ mm/min)
	1 : inch	0.001 to 600000.000 (inch/min)	1 to 600000000 ($\times 10^{-3}$ inch/min)
	2 : degree	0.001 to 600000.000 (degree/min)	1 to 600000000 ($\times 10^{-3}$ degree/min)
	3 : pulse	1 to 1000000 (pulse/s)	1 to 1000000 (pulse/s)
1 : Stepping motor mode	0 : mm	0.01 to 375000.00 (mm/min)	1 to 37500000 ($\times 10^{-2}$ mm/min)
	1 : inch	0.001 to 37500.000 (inch/min)	1 to 37500000 ($\times 10^{-3}$ inch/min)
	2 : degree	0.001 to 37500.000 (degree/min)	1 to 37500000 ($\times 10^{-3}$ degree/min)
	3 : pulse	1 to 62500 (pulse/s)	1 to 62500 (pulse/s)

[Table 2]

Pr.25 setting value	Value set with peripheral device (ms)	Value set with sequence program (ms)
0 : 1-word type	1 to 65535	1 to 65535*
1 : 2-word type	1 to 8388608	1 to 8388608

- * 1 to 32767 : Set as a decimal
32768 to 65535 : Convert into hexadecimal and set

Pr.10 Bias speed at start

Set the "minimum speed for starting" for the "bias speed at start". This is set to smoothly start the motor, such as when using a stepping motor. (If the motor speed is slow when starting, the stepping motor will not start smoothly.)

The set "bias speed at start" is valid for the following operation.

- Positioning operation
- Zero point return
- JOG operation

Pr.11 Stepping motor mode selection

The type of motor controlled with the AD75 is set with the "stepping motor mode selection".

- 1 : Stepping motor mode When using a stepping motor
- 0 : Standard mode When using a different type of motor

When carrying out 2-axis interpolation control using both the stepping motor and servomotor, set both axes to "1: Stepping motor mode". (For example, when connecting axis 1 to the stepping motor and connecting axis 2 to the servomotor, and carrying out interpolation control of axis 1 and axis 2.)



Note) Refer to the section "12.6.6 Stepping motor mode function" for the limits that apply when the stepping motor mode is selected.

Control	Applicable motor	Pr.11 setting value for each axis
When each axis is independently controlled	Stepping motor	1
	Other motor	0
2-axis interpolation control	Stepping motor × 2	1
	Stepping motor × 1 Other motor × 1	
	Other motor × 2	0

POINT

If any of " Pr.7 Speed limit value", " Pr.8 Acceleration time 0" and " Pr.9 Deceleration time 0" are changed during positioning control, it will be changed a maximum of three data later with the exception of the "positioning data No." that is being executed when a change is made.

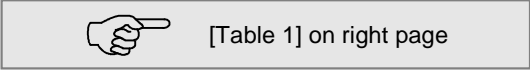
5.2.3 Detailed parameters 1

Item	Setting value, setting range		Default value	Setting value buffer memory address		
	Value set with peripheral device	Value set with sequence program		Axis 1	Axis 2	Axis 3
Pr.12 Backlash compensation amount	The setting value range differs according to the "Pr.1 Unit setting". Here, the value within the [Table 1] range is set. 		0	15	165	315
Pr.13 Software stroke limit upper limit value	The setting value range differs depending on the "Pr.11 Stepping motor mode selection" or "Pr.1 Unit setting". Here, the value within the [Table 2] range is set. 		2147483647	16 17	166 167	316 317
Pr.14 Software stroke limit lower limit value			-2147483648	18 19	168 169	318 319
Pr.15 Software stroke limit selection	0 : Apply software stroke limit on current feed value	0	0	20	170	320
	1 : Apply software stroke limit on machine feed value	1				
Pr.16 Software stroke limit valid/invalid setting	0 : Software stroke limit invalid during JOG operation and manual pulse generator operation	0	0	21	171	321
	1 : Software stroke limit valid during JOG operation and manual pulse generator operation	1				

Pr.12 Backlash compensation amount

The error that occurs due to backlash when moving the machine via gears can be compensated.

When the backlash compensation amount is set, pulses equivalent to the compensation amount will be output each time the direction changes during positioning.

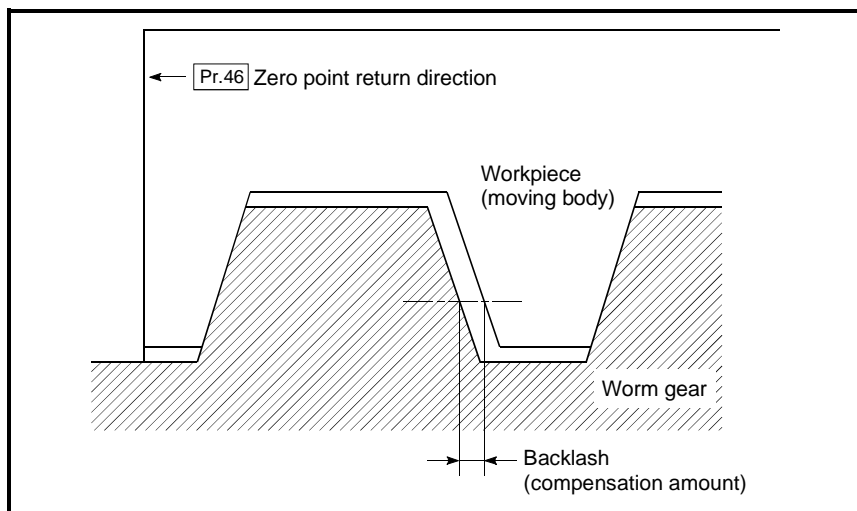

- 1) The backlash compensation is valid after completed the machine zero point return. Thus, if the backlash compensation amount is set or changed, always carry out machine zero point return once.
- 2) The backlash compensation amount setting range is 0 to 65535, but it should be set to 255 or less by using the following expression.

$$0 \leq \frac{\text{Backlash compensation amount}}{\text{Movement amount per pulse}} \leq 255$$

[Table 1]

Pr.1 setting value	Value set with peripheral device (unit)	Value set with sequence program (unit) *
0 : mm	0 to 6553.5 (μm)	0 to 65535 (×10 ⁻¹ μm)
1 : inch	0 to 0.65535 (inch)	0 to 65535 (×10 ⁻⁵ inch)
2 : degree	0 to 0.65535 (degree)	0 to 65535 (×10 ⁻⁵ degree)
3 : pulse	0 to 65535 (pulse)	0 to 65535 (pulse)

* 1 to 32767 : Set as a decimal
 32768 to 65535 : Convert into hexadecimal and set

[Table 2]

Pr.11 setting value	Pr.1 setting value	Value set with peripheral device (unit)	Value set with sequence program (unit)
0 : Standard mode	0 : mm	-214748364.8 to 214748364.7 (μm)	-2147483648 to 2147483647 (×10 ⁻¹ μm)
	1 : inch	-21474.83648 to 21474.83647(inch)	-2147483648 to 2147483647 (×10 ⁻⁵ inch)
	2 : degree	0 to 359.99999 (degree)	0 to 35999999 (×10 ⁻⁵ degree)
	3 : pulse	-2147483648 to 2147483647(pulse)	-2147483648 to 2147483647 (pulse)
1 : Stepping motor mode	0 : mm	-13421772.8 to 13421772.7 (μm)	-134217728 to 134217727 (×10 ⁻¹ μm)
	1 : inch	-1342.17728 to 1342.17727 (inch)	-134217728 to 134217727 (×10 ⁻⁵ inch)
	2 : degree	0 to 359.99999 (degree)	0 to 35999999 (×10 ⁻⁵ degree)
	3 : pulse	-134217728 to 134217727 (pulse)	-134217728 to 134217727(pulse)

Pr.13 Software stroke limit upper limit value

Set the upper limit for the machine's movement range during positioning control.

Pr.14 Software stroke limit lower limit value

Set the lower limit for the machine's movement range during positioning control.

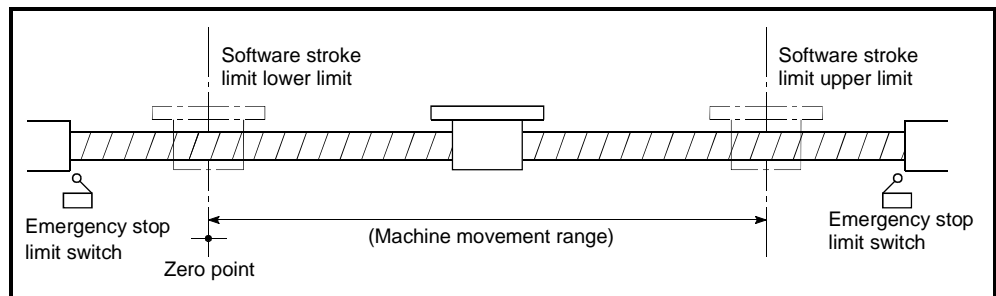

- 1) Generally, the zero point is set at the lower limit or upper limit of the stroke limit.
- 2) By setting the upper limit value or lower limit value of the software stroke limit, overrun can be prevented in the software. However, an emergency stop limit switch must be installed nearby outside the range.
- 3) To invalidate the software stroke limit, set the setting value to "upper limit value = lower limit value". (The setting value can be anything.)
- 4) When the unit is "degree", the software stroke limit check is invalid during speed control (including speed/position chageover control) or during manual control.

Pr.15 Software stroke limit selection

Set whether to apply the software stroke limit on the "current feed value" or the "machine feed value". The software stroke limit will be validated according to the set value.

Pr.16 Software stroke limit valid/invalid setting

Set whether to validate the software stroke limit during JOG operation and manual pulse generator operation.

Item	Setting value, setting range		Default value	Setting value buffer memory address		
	Value set with peripheral device	Value set with sequence program		Axis 1	Axis 2	Axis 3
Pr.17 Command in-position width	The setting value range differs depending on the " Pr.11 Stepping motor mode selection" or " Pr.1 Unit setting". Here, the value within the [Table 1] range is set. <div style="border: 1px solid gray; padding: 5px; display: inline-block;"> [Table 1] on right page </div>		100	22 23	172 173	322 323
Pr.18 Torque limit setting value	1 to 500 (%)	1 to 500 (%)	300	24	174	324
Pr.19 M code ON signal output timing	0 : WITH mode	0	0	25	175	325
	1 : AFTER mode	1				

Pr.17 Command in-position width

Set the remaining distance that turns the command in-position ON. When positioning control is started, the "command in-position flag" (b2) in "**Md.40** Status" turns OFF, and the "command in-position flag" turns ON in the range of the command in-position.

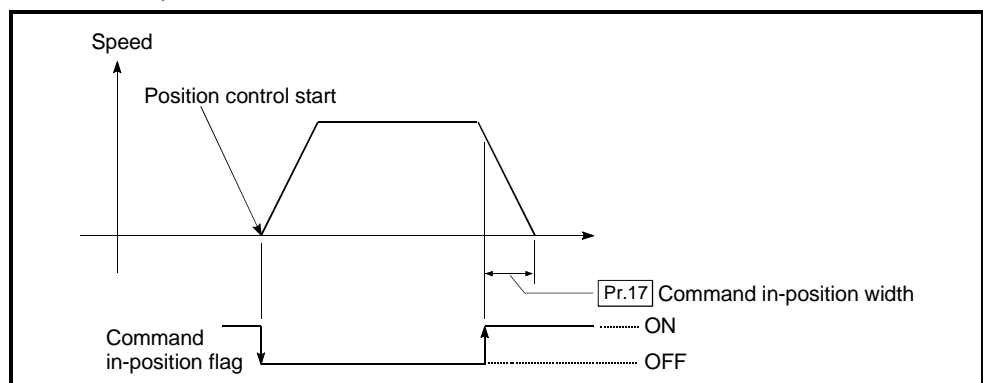

Pr.18 Torque limit setting value

With this function, the torque generated by the motor is limited to within the set range.

* The torque exceeding the limit is reduced to the specified torque limit. Set the maximum torque value necessary for the control in the range between 1 and 500%.

Usage conditions
Limits for pulse train output type
(a) A drive unit that can issue a torque limit command with the analog voltage is required.
(b) The D/A conversion module and the D/A conversion module and drive unit must be wired.
(c) The set "Pr.18 Torque limit setting value" is set in the buffer memory "Md.45 Torque limit stored value", so transmit that "Md.45 Torque limit stored value" to the D/A conversion module with the sequence program.

[Table 1]

Pr.11 setting value	Pr.1 setting value	Value set with peripheral device (unit)	Value set with sequence program (unit)
0 : Standard mode	0 : mm	0.1 to 3276700.0 (μm)	1 to 32767000 (×10 ⁻¹ μm)
	1 : inch	0.00001 to 327.67000 (inch)	1 to 32767000 (×10 ⁻⁵ inch)
	2 : degree	0.00001 to 327.67000 (degree)	1 to 32767000 (×10 ⁻⁵ degree)
	3 : pulse	1 to 32767 (pulse)	1 to 32767 (pulse)
1 : Stepping motor mode	0 : mm	0.1 to 204793.7 (μm)	1 to 2047937 (×10 ⁻¹ μm)
	1 : inch	0.00001 to 20.47937 (inch)	1 to 2047937 (×10 ⁻⁵ inch)
	2 : degree	0.00001 to 20.47937 (degree)	1 to 2047937 (×10 ⁻⁵ degree)
	3 : pulse	1 to 2047 (pulse)	1 to 2047 (pulse)

Pr.19 M code ON signal output timing

Set the timing to output the M code ON signal.

The WITH mode and AFTER mode can be used for the M code ON signal output timing.

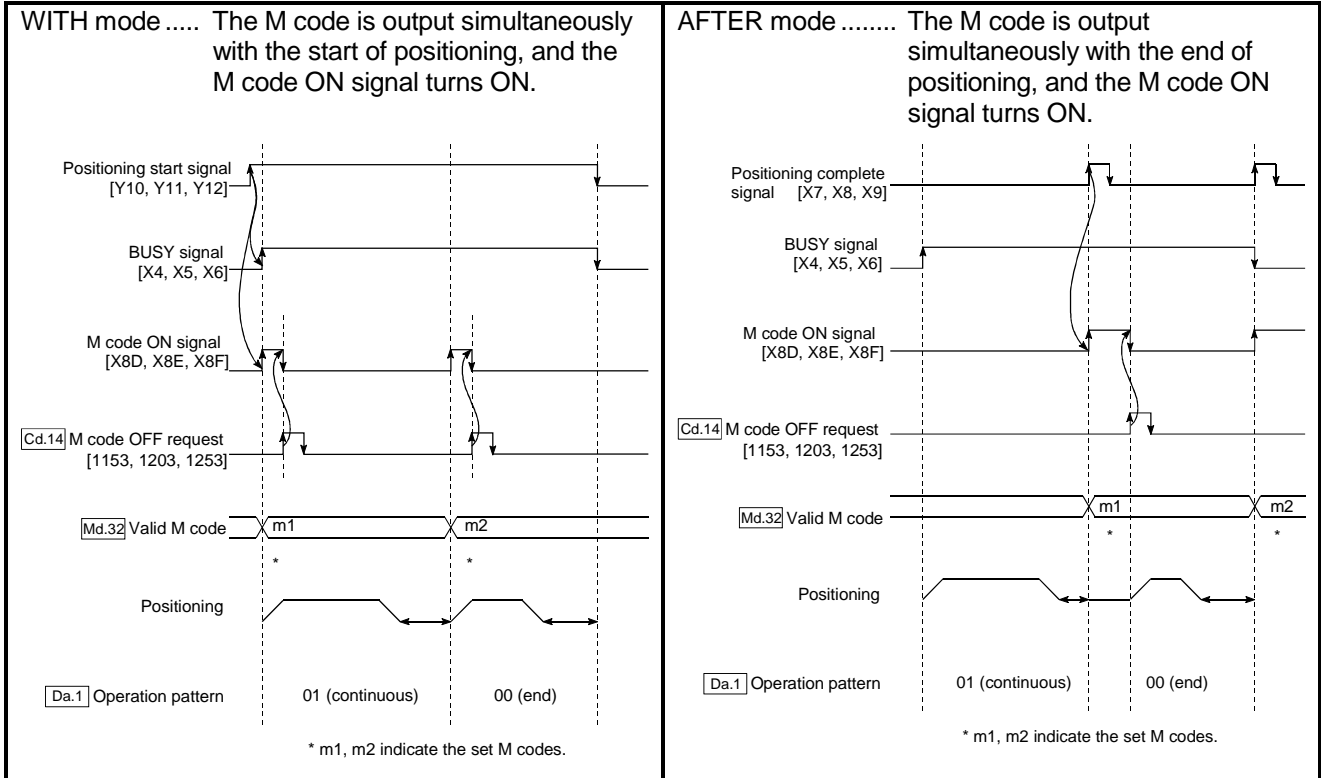

Note) When using the AFTER mode with speed control, the M code will not be output and the M code ON signal will not turn ON.

The M code is a No. between 0 and 32767 that can be set for each positioning data (**Da.9**).

When the M code ON signal [XD, XE, XF] turns ON, "**Md.32** Valid M code" is read from the buffer memory by the sequence program, and an auxiliary work (ex., clamping, drill rotation, tool change, etc.) matching the code No. can be issued.

Item	Setting value, setting range		Default value	Setting value buffer memory address		
	Value set with peripheral device	Value set with sequence program		Axis 1	Axis 2	Axis 3
Pr.20 Speed changeover mode	0 : Standard speed changeover mode	0	0	26	176	326
	1 : Front-loading speed changeover mode	1				
Pr.21 Interpolation speed designation method	0 : Composite speed	0	0	27	177	327
	1 : Reference axis speed	1				
Pr.22 Current feed value during speed control	0 : Do not update current feed value	0	0	28	178	328
	1 : Update current feed value	1				
	2 : Clear current feed value to zero	2				
Pr.23 Manual pulse generator selection	0 : Ignore manual pulse generator operation	0	Axis 1 = 1 Axis 2 = 2 Axis 3 = 3	29	179	329
	1 : Use manual pulse generator 1	1				
	2 : Use manual pulse generator 2	2				
	3 : Use manual pulse generator 3	3				
Pr.24 Logic selection for pulse output to the drive unit	0 : Positive logic	0	0	30	180	330
	1 : Negative logic	1				
Pr.25 Size selection for acceleration/ deceleration time	0 : 1-word type (1 to 65535ms)	0	0	31	181	331
	1 : 2-word type (1 to 8388608ms)	1				

Pr.20 Speed changeover mode

Set whether to change the speed changeover mode with the standard changeover or front-loading changeover mode.

0 : Standard changeover Change the speed when executing the next positioning data.

1 : Front-loading changeover The speed changes at the end of the positioning data currently being executed.

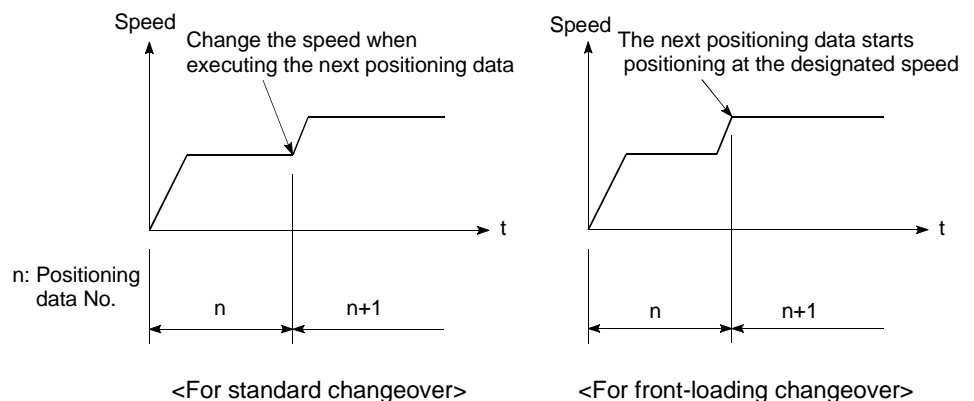

Pr.21 Interpolation speed designation method

When carrying out linear interpolation, set whether to designate the composite speed or reference axis speed.

- 0: Composite speed The movement speed for the control target is designated, and the speed for each axis is calculated by the AD75.
- 1: Reference axis speed The axis speed set for the reference axis is designated, and the speed for the other axis carrying out interpolation is calculated by the AD75.

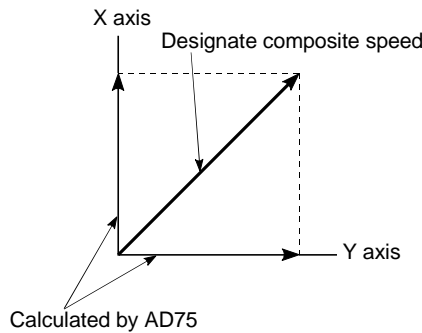

<When composite speed is designated>

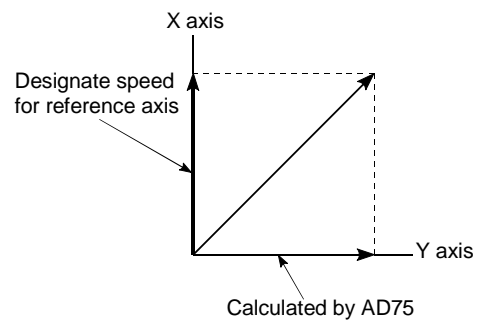

<When reference axis speed is designated>

Note) For a positioning operation that involves the circular interpolation, specify the composite speed always.

Pr.22 Current feed value during speed control

When carrying out speed control (including speed control during speed/position changeover control), set whether to update the "[Md.29] Current feed value".

- 0 : Do not update current feed value The current feed value is not updated. (The current feed value at the start of speed control is held.)
- 1 : Update current feed value The current feed value is updated. (The current feed value is updated when speed control is started.)
- 2 : Clear current feed value to zero The current feed value is cleared to "0", and is not updated.

Pr.23 Manual pulse generator selection

Set which manual pulse generator to use for control for each axis (motor).

- 0 : Ignore manual pulse generator operation..... Manual pulse generator operation is not carried out.
- 1 : Use manual pulse generator 1..... Control with manual pulse generator connected to axis 1.
- 2 : Use manual pulse generator 2..... Control with manual pulse generator connected to axis 2.
- 3 : Use manual pulse generator 3..... Control with manual pulse generator connected to axis 3.

Example 1) To correspond axis to control and manual pulse generator

Example 2) To control all axes with one manual pulse generator (manual pulse generator 1)

Axis (buffer memory address)	Setting for Example 1)	Setting for Example 2)
Axis 1 (29)	1	1
Axis 2 (179)	2	1
Axis 3 (329)	3	1

Pr.24 Logic selection for pulse output to the drive unit

Set the pulse output logic of the AD75 according to the drive unit connected to the AD75.

- 0 : Positive logic When drive unit's pulse input logic is positive.
- 1 : Negative logic When drive unit's pulse input logic is negative.

Note) The pulse input logic of the drive unit changes depending on the drive unit. If not set correctly, the drive unit will not operate correctly. For the pulse output logic of the AD75, refer to section "3.5 Specifications of input/output interfaces with external devices".

Pr.25 Size selection for acceleration/deceleration time

Select the setting size for the acceleration/deceleration time. The setting size such as "Acceleration time 0 to 3", "Deceleration time 0 to 3" and "Sudden stop deceleration time" is determined by this setting size.

- 0 : Acceleration/deceleration time 1 to 65535ms (1-word type)
 - 1 : Acceleration/deceleration time 1 to 8388608ms (2-word type)
- Normally, select "0 : Acceleration/deceleration time 1 to 65535ms (1-word type)".

Note) • Before selecting the "1: Acceleration/deceleration time 1 to 8388608ms (2-word type)", confirm that there is sufficient movement amount and that constant speed movement is possible. Do not use this setting if the movement amount is remarkably small, or if the speed is slow.
 • When changing the "acceleration/deceleration time size" from the 2-word type to the 1-word type, check that all acceleration/deceleration time setting values are within the "acceleration/deceleration time size" setting range.

5.2.4 Detailed parameters 2

Item	Setting value, setting range		Default value	Setting value buffer memory address		
	Value set with peripheral device	Value set with sequence program		Axis 1	Axis 2	Axis 3
Pr.26 Acceleration time 1	The setting value range differs according to the "Pr.25 Size selection for acceleration/deceleration time" setting. Here, the value within the [Table 1] range is set. <div style="text-align: center; border: 1px solid black; padding: 5px; margin: 10px 0;"> [Table 1] on right page </div>		1000	36	186	336
Pr.27 Acceleration time 2				37	187	337
Pr.28 Acceleration time 3				38	188	338
Pr.29 Deceleration time 1				39	189	339
Pr.30 Deceleration time 2				40	190	340
Pr.31 Deceleration time 3				41	191	341
Pr.29 Deceleration time 1	42	192	342			
Pr.30 Deceleration time 2	43	193	343			
Pr.31 Deceleration time 3	44	194	344			
Pr.29 Deceleration time 1	45	195	345			
Pr.30 Deceleration time 2	46	196	346			
Pr.31 Deceleration time 3	47	197	347			
Pr.32 JOG speed limit value	The setting value range differs depending on the "Pr.11 Stepping motor mode selection" or "Pr.1 Unit setting". Here, the value within the [Table 2] range is set. <div style="text-align: center; border: 1px solid black; padding: 5px; margin: 10px 0;"> [Table 2] on right page </div>		20000	48	198	348
Pr.32 JOG speed limit value	49	199	349			
Pr.33 JOG operation acceleration time selection	0 : Pr.8 Acceleration time 0	0	0	50	200	350
	1 : Pr.26 Acceleration time 1	1				
	2 : Pr.27 Acceleration time 2	2				
	3 : Pr.28 Acceleration time 3	3				
Pr.34 JOG operation deceleration time selection	0 : Pr.9 Deceleration time 0	0	0	51	201	351
	1 : Pr.29 Deceleration time 1	1				
	2 : Pr.30 Deceleration time 2	2				
	3 : Pr.31 Deceleration time 3	3				

Pr.26 Acceleration time 1 to Pr.28 Acceleration time 3

Set the item to reach "Pr.7 Speed limit value" from speed 0 during positioning operation.

The setting value size is determined by "Pr.25 Size selection for acceleration/deceleration time".

Pr.29 Deceleration time 1 to Pr.31 Deceleration time 3

Set the item to reach speed 0 from "Pr.7 Speed limit value" during positioning operation.

The setting value size is determined by "Pr.25 Size selection for acceleration/deceleration time".

[Table 1]

Pr.25 setting value	Value set with peripheral device (ms)	Value set with sequence program (ms)
0 : 1-word type	1 to 65535	1 to 65535*
1 : 2-word type	1 to 8388608	1 to 8388608

* 1 to 32767 : Set as a decimal
32768 to 65535 : Convert into hexadecimal and set

[Table 2]

Pr.11 setting value	Pr.1 setting value	Value set with peripheral device (unit)	Value set with sequence program (unit)
0 : Standard mode	0 : mm	0.01 to 6000000.00 (mm/min)	1 to 600000000 ($\times 10^{-2}$ mm/min)
	1 : inch	0.001 to 600000.000 (inch/min)	1 to 600000000 ($\times 10^{-3}$ inch/min)
	2 : degree	0.001 to 600000.000 (degree/min)	1 to 600000000 ($\times 10^{-3}$ degree/min)
	3 : pulse	1 to 1000000 (pulse/s)	1 to 1000000 (pulse/s)
1 : Stepping motor mode	0 : mm	0.01 to 375000.00 (mm/min)	1 to 37500000 ($\times 10^{-2}$ mm/min)
	1 : inch	0.001 to 37500.000 (inch/min)	1 to 37500000 ($\times 10^{-3}$ inch/min)
	2 : degree	0.001 to 37500.000 (degree/min)	1 to 37500000 ($\times 10^{-3}$ degree/min)
	3 : pulse	1 to 62500 (pulse/s)	1 to 62500 (pulse/s)

Pr.32 JOG speed limit value

Set the maximum speed for JOG operation.

Note) Set the "JOG speed limit value" to less than "Pr.7 Speed limit value".
If the "speed limit value" is exceeded, the "JOG speed limit value error"
(error code: 956) will occur.

Pr.33 JOG operation acceleration time selection

Set which of "acceleration time 0 to 3" to use for the acceleration time during JOG operation.

- 0 : Use value set in "Pr.8 Acceleration time 0".
- 1 : Use value set in "Pr.26 Acceleration time 1".
- 2 : Use value set in "Pr.27 Acceleration time 2".
- 3 : Use value set in "Pr.28 Acceleration time 3".

Pr.34 JOG operation deceleration time selection

Set which of "deceleration time 0 to 3" to use for the deceleration time during JOG operation.

- 0 : Use value set in "Pr.9 Deceleration time 0".
- 1 : Use value set in "Pr.29 Deceleration time 1".
- 2 : Use value set in "Pr.30 Deceleration time 2".
- 3 : Use value set in "Pr.31 Deceleration time 3".

Item	Setting value, setting range		Default value	Setting value buffer memory address		
	Value set with peripheral device	Value set with sequence program		Axis 1	Axis 2	Axis 3
Pr.35 Acceleration/deceleration process selection	0 : Automatic trapezoid acceleration/deceleration process	0	0	52	202	352
	1 : S-curve acceleration/deceleration process	1				
Pr.36 S-curve ratio	1 to 100 (%)	1 to 100 (%)	100	53	203	353
Pr.37 Sudden stop deceleration time	The setting value range differs according to the "Pr.25 Size selection for acceleration/deceleration time" setting. Here, the value within the [Table 1] range is set. 		1000	54 55	204 205	354 355
Pr.38 Stop group 1 sudden stop selection	0 : Normal deceleration stop	0	0	56	206	356
Pr.39 Stop group 2 sudden stop selection				57	207	357
Pr.40 Stop group 3 sudden stop selection	1 : Sudden stop	1		58	208	358

Pr.35 Acceleration/deceleration process selection

Set whether to use automatic trapezoid acceleration/deceleration or S-curve acceleration/deceleration for the acceleration/deceleration process.

Note) Refer to section "12.6.7 Acceleration/deceleration process function" for details.

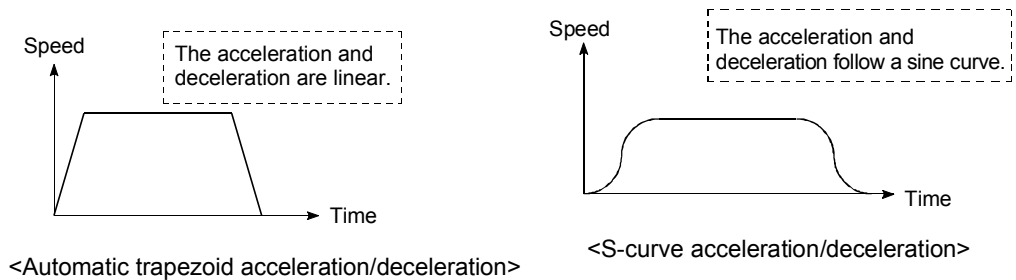

The S-curve acceleration/deceleration is disable when a stepping motor is used.

Pr.36 S-curve ratio

Set the S-curve ratio (1 to 100%) for carrying out the S-curve acceleration/deceleration process.

The S-curve ratio indicates where to draw the acceleration/deceleration curve using the sine curve as shown below.

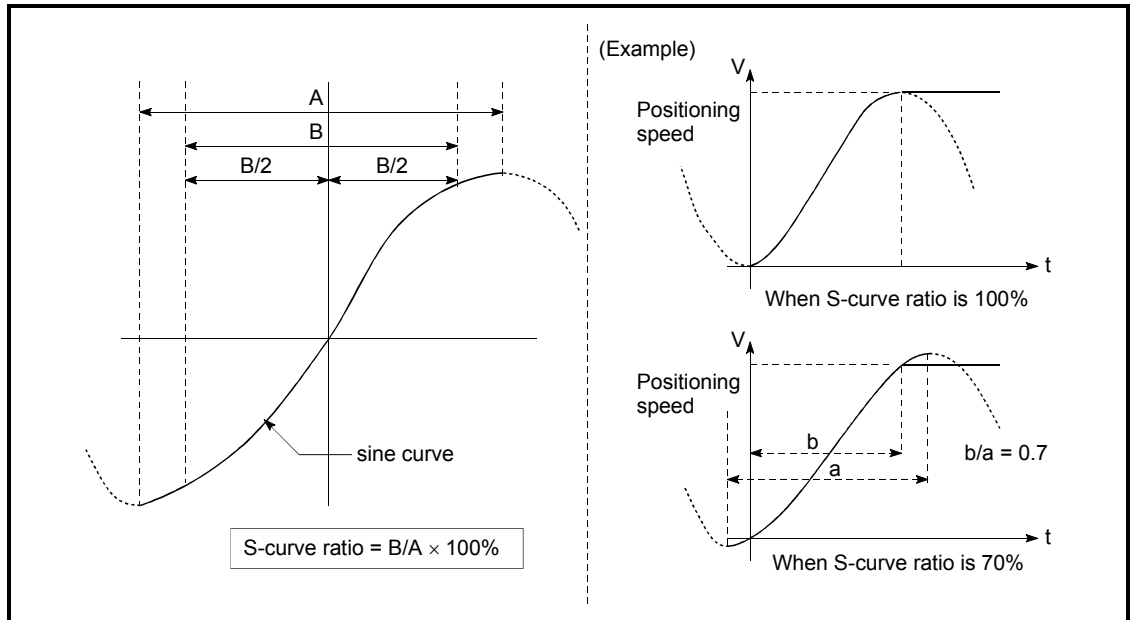

[Table 1]

Pr.25 setting value	Value set with peripheral device (ms)	Value set with sequence program (ms)
0 : 1-word type	1 to 65535	1 to 65535*
1 : 2-word type	1 to 8388608	1 to 8388608

* 1 to 32767 : Set as a decimal
 32768 to 65535 : Convert into hexadecimal and set

Pr.37 Sudden stop deceleration time

Set the time to reach speed 0 from "Pr.7 Speed limit value" during the sudden stop. The setting value size is determined by "Pr.25 Size selection for acceleration/deceleration time". The relation with the other parameters is as shown below.

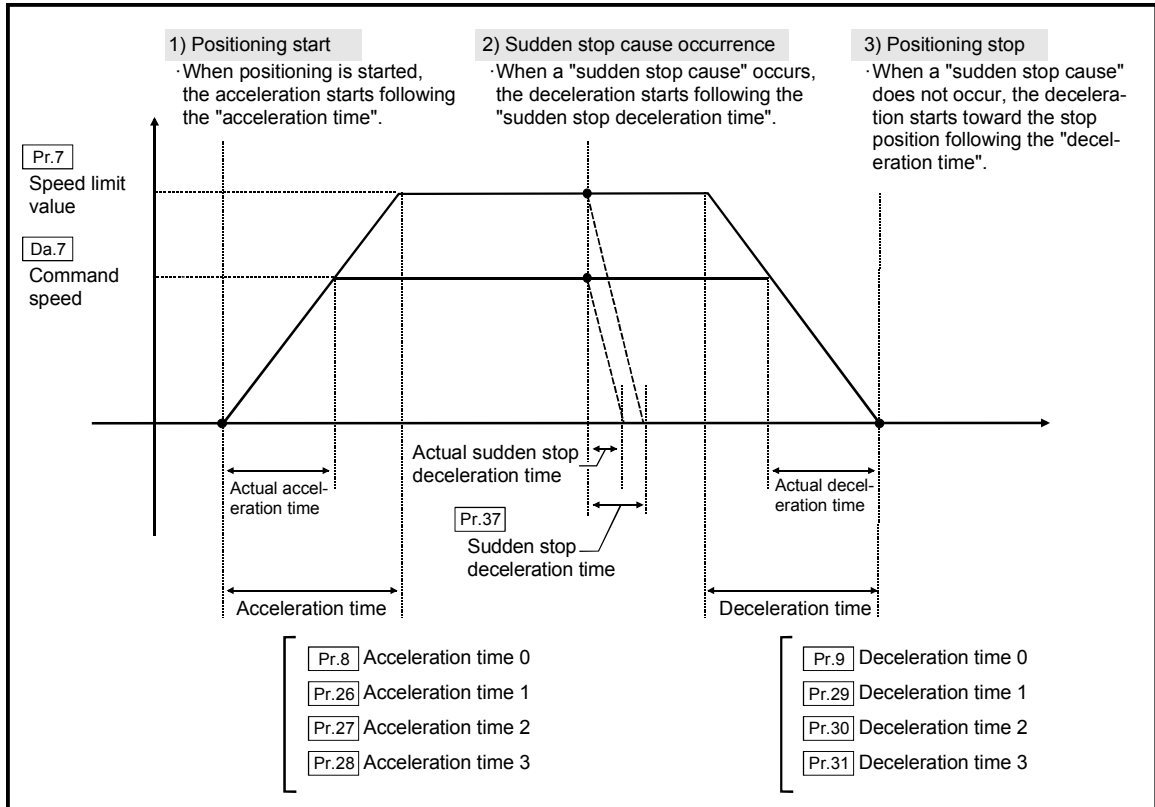

Pr.38 Stop group 1 sudden stop selection
to

Pr.40 Stop group 3 sudden stop selection

Set the method to stop when the stop causes in the following stop groups occur.

- Stop group 1 Stop with hardware stroke limit
- Stop group 2 Stop with software stroke limit
Stop signal from peripheral device, PLC READY signal
OFF
- Stop group 3 External stop signal
Stop signal from PLC
Error occurrence (excluding errors in stop group 1 and 2)
Stop caused by an ON --> OFF change at the near-point
dog during count method machine zero point return made
at a near-point dog ON. (Refer to sections 8.2.7 and
8.2.8.)

The methods of stopping include "0: Normal deceleration stop" and "1: Sudden stop".

If "1: Sudden stop" is selected, the axis will suddenly decelerate to a stop when the stop signal is input.

Item	Setting value, setting range		Default value	Setting value buffer memory address		
	Value set with peripheral device	Value set with sequence program		Axis 1	Axis 2	Axis 3
Pr.41 Positioning complete signal output time	0 to 65535 (ms)	0 to 65535 (ms) 0 to 32767 : Set as a decimal 32768 to 65535: Convert into hexadecimal and set	300	59	209	359
Pr.42 Allowable circular interpolation error width	The setting value range differs depending on the "Pr.1 Unit setting". (When the stepping motor is used, circular interpolation control cannot be performed. Set "Pr.11 Stepping motor mode selection" to "0: Standard mode".) Here, the value within the [Table 1] range is set.		100	60 61	210 211	360 361
Pr.43 External start function selection	0 : External positioning start	0	0	62	212	362
	1 : External speed change request	1				
	2 : Skip request	2				
Pr.44 Near pass mode selection for path control	0 : Positioning address pass mode	0	0	66	216	366
	1 : Near pass mode	1				

Pr.41 Positioning complete signal output time

Set the output time of the positioning complete signal [X7, X8, X9] output from the AD75.

Positioning complete refers to the state in which the output of pulses from the AD75 has completed, and the specified dwell time has passed.

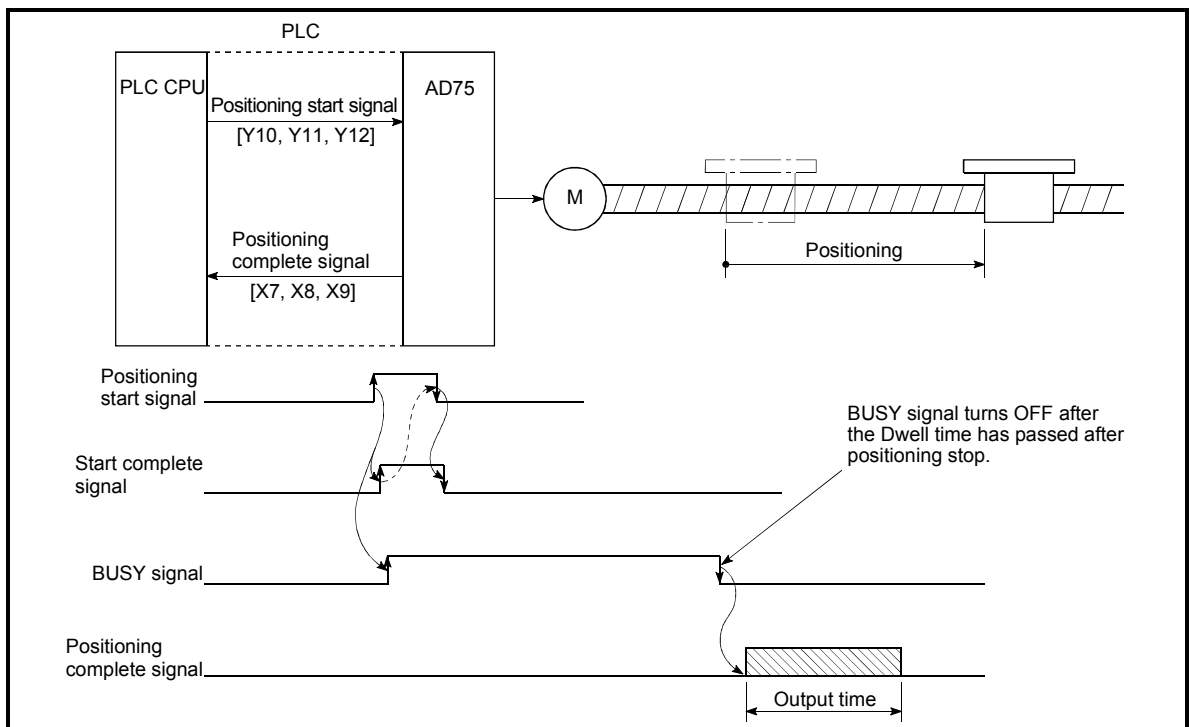

Positioning complete signal output time

[Table 1]

Pr.11 setting value	Pr.1 setting value	Value set with peripheral device (unit)	Value set with sequence program (unit)
0 : Standard mode	0 : mm	0 to 10000.0 (μm)	0 to 100000 ($\times 10^{-1}\mu\text{m}$)
	1 : inch	0 to 1.00000 (inch)	0 to 100000 ($\times 10^{-5}\text{inch}$)
	2 : degree	0 to 1.00000 (degree)	0 to 100000 ($\times 10^{-5}\text{degree}$)
	3 : pulse	0 to 100000 (pulse)	0 to 100000 (pulse)

Pr.42 Allowable circular interpolation error width

With the "allowable circular interpolation error width", the allowable error range of the calculated arc path and end point address is set. If the error of the calculated arc path and end point address is within the set range, circular interpolation will be carried out to the set end point address while compensating the error with spiral interpolation.

The allowable circular interpolation error width is set in the reference axis buffer memory addresses.

- For circular interpolation in axis 1 and axis 2, set in the axis 1 buffer memory address [60, 61]
- For circular interpolation in axis 2 and axis 3, set in the axis 2 buffer memory address [210, 211]
- For circular interpolation in axis 3 and axis 1, set in the axis 3 buffer memory address [360, 361]

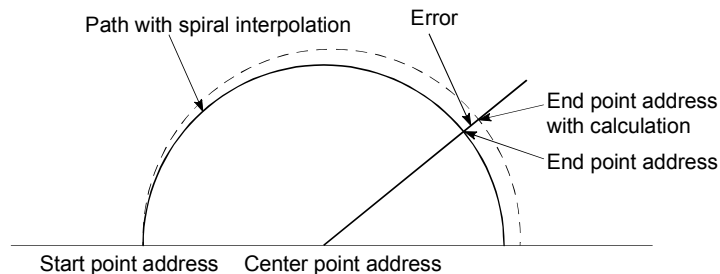

- * With circular interpolation control using the center point designation, the arc path calculated with the start point address and center point address and the end point address may deviate.

Pr.43 External start function selection

Set which function to use the external start signal with.

- 0 : External positioning start Carry out positioning operation with external start signal input.
- 1 : External speed change request..... Change the speed of the positioning operation currently being executed with the external start signal input.
In this case, set the new speed value in "[Cd.16] New speed value".
- 2 : Skip request The positioning operation currently being carried out is skipped with the external start signal input.

POINT

"[Cd.25] External start valid" must be set to validate the external start signal.

Pr.44 Near pass mode selection for path control

Set the method to carry out control between positioning data items during continuous path control of the AD75 interpolation control.

- 0 : Positioning address pass mode... The address designated in the "positioning data" is passed, but the speed output when the corresponding positioning address is passed may drop momentarily.
- 1 : Near pass mode..... Since positioning is not performed at the address designated in the "positioning data", the path merely passes near the designated positioning address, but machine vibration caused by the momentary output speed drop can be suppressed.

Note) Refer to section "12.3.3 Near pass mode function" for details on the near pass mode.

5.2.5 Zero point return basic parameters

Item	Setting value, setting range		Default value	Setting value buffer memory address		
	Value set with peripheral device	Value set with sequence program		Axis 1	Axis 2	Axis 3
Pr.45 Zero point return method	0 : Near-point dog method	0	0	70	220	370
	1 : Stopper stop method 1)	1				
	2 : Stopper stop method 2)	2				
	3 : Stopper stop method 3)	3				
	4 : Count method 1)	4				
	5 : Count method 2)	5				

Pr.45 Zero point return method

Set the "zero point return method" for carrying out machine zero point return.

- 0 : Near-point dog method After decelerating at the near-point dog ON, stop at the zero point signal and complete the machine zero point return.
- 1 : Stopper stop method 1) After decelerating at the near-point dog ON, stop with the stopper, and complete the machine zero point return after the dwell time has passed.
- 2 : Stopper stop method 2) After decelerating at the near-point dog ON, stop with the stopper, and complete the machine zero point return with the zero point signal.
- 3 : Stopper stop method 3) After starting with the creep speed, stop with the stopper, and complete the machine zero point return with the zero point signal.
- 4 : Count method 1) After decelerating at the near-point dog ON, move the designated distance, and complete the machine zero point return with the machine zero point signal.
- 5 : Count method 2) After decelerating at the near-point dog ON, move the designated distance, and complete the machine zero point return.

Note) Refer to section "8.2.2 Machine zero point return method" for details on the zero point return methods.

Zero point return method

0 : Near-point dog method

- (1) Start machine zero point return. (Start machine movement at the "Pr.48 Zero point return speed" in the "Pr.46 Zero point return direction".)
- (2) Detect the near-point dog ON, and start deceleration.
- (3) Decelerate to "Pr.49 Creep speed", and move with the creep speed.
- (4) At the first zero point signal (single-pulse output per motor revolution) after the near-point dog OFF, the pulse output from the AD75 stops, and the machine zero point return is completed.

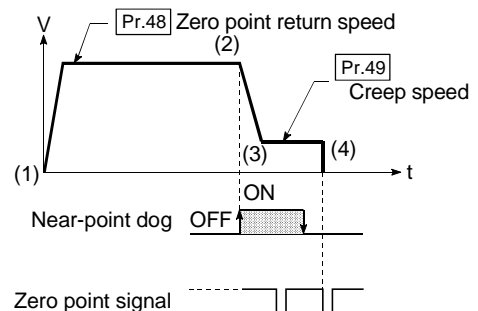

1 : Stopper stop method 1)

- (1) Start machine zero point return.
(Start movement at the "Pr.48 Zero point return speed" in the "Pr.46 Zero point return direction".)
- (2) Detect the near-point dog ON, and start deceleration.
- (3) Decelerate to "Pr.49 Creep speed", and move with the creep speed.
(At this time, setting for the "Pr.56 Zero point return torque limit value" is required. If the torque is not limited, the servomotor could be damaged in step (4).)
- (4) The axis contacts against the stopper at the "Pr.49 Creep speed", and then stops.
- (5) When the near-point dog turns ON and the "Pr.51 Zero point return dwell time" is passed, the pulse output from the AD75 stops and the machine zero point return is completed.

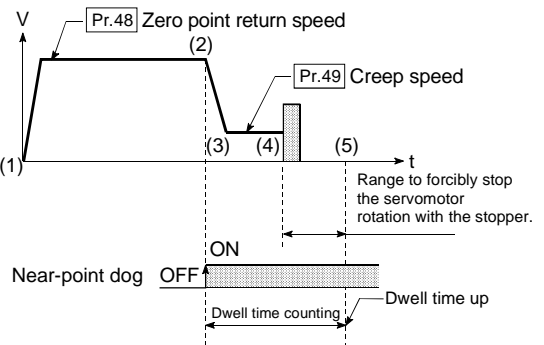

2 : Stopper stop method 2)

- (1) Start machine zero point return.
(Start movement at the "Pr.48 Zero point return speed" in the "Pr.46 Zero point return direction".)
- (2) Detect the near-point dog ON, and start deceleration.
- (3) Decelerate to "Pr.49 Creep speed", and move with the creep speed.
(At this time, setting for the "Pr.56 Zero point return torque limit value" is required. If the torque is not limited, the servomotor could be damaged in step (4).)
- (4) The axis contacts against the stopper at the "Pr.49 Creep speed", and then stops.
- (5) After stopping, the pulse output from the AD75 stops with the zero point signal (a signal issued from an external device upon detection of contact with the stopper), and the machine zero point return is completed.

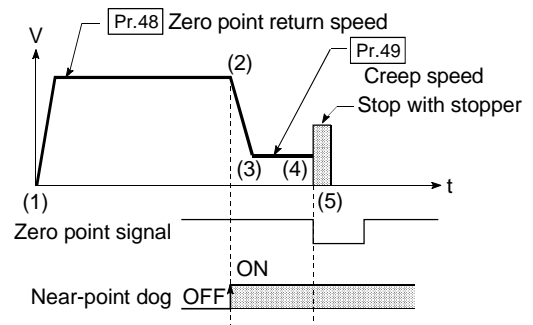

3 : Stopper stop method 3)

- (1) Start machine zero point return.
(Start movement at the "Pr.49 Creep speed" in the "Pr.46 Zero point return direction". At this time, setting for the "Pr.56 Zero point return torque limit value" is required. If the torque is not limited, the servomotor could be damaged in step (2).)
- (2) The axis contacts against the stopper at the "Pr.49 Creep speed", and then stops.
- (3) After stopping, the pulse output from the AD75 stops with the zero point signal (a signal issued from an external device upon detection of contact with the stopper), and the machine zero point return is completed.

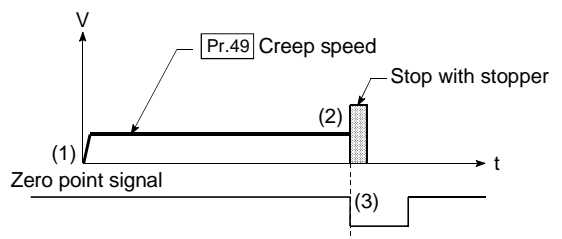

4 : Count method 1)

- (1) Start machine zero point return.
(Start movement at the "Pr.48 Zero point return speed" in the "Pr.46 Zero point return direction".)
- (2) Detect the near-point dog ON, and start deceleration.
- (3) Decelerate to "Pr.49 Creep speed", and move with the creep speed.
- (4) After the near-point dog turns ON and the movement amount set in "Pr.52 Setting for the movement amount after near-point dog ON" has passed, the pulse output from the AD75 stops with the first zero point signal (single-pulse output per motor revolution), and the machine zero point return is completed.

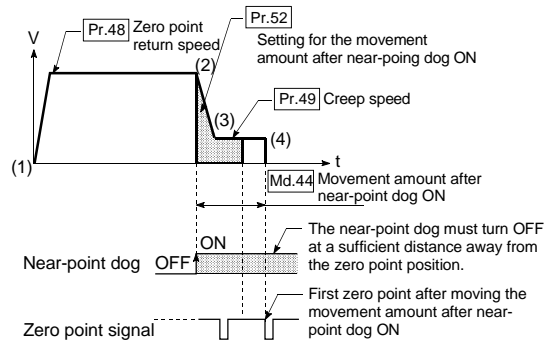

5 : Count method 2)

- (1) Start machine zero point return.
(Start movement at the "Pr.48 Zero point return speed" in the "Pr.46 Zero point return direction".)
- (2) Detect the near-point dog ON, and start deceleration.
- (3) Decelerate to "Pr.49 Creep speed", and move with the creep speed.
- (4) After the near-point dog turns ON and the movement amount set in "Pr.52 Setting for the movement amount after near-point dog ON" has passed, the pulse output from the AD75 stops, and the machine zero point return is completed.

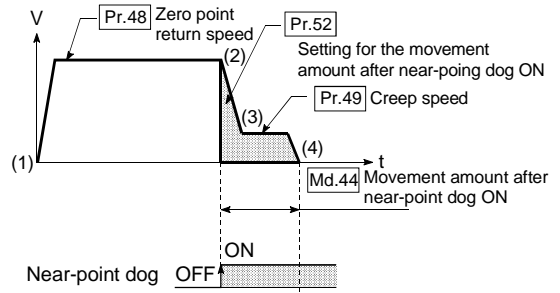

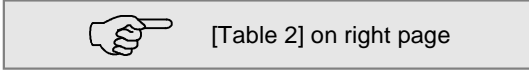
Item	Setting value, setting range		Default value	Setting value buffer memory address		
	Value set with peripheral device	Value set with sequence program		Axis 1	Axis 2	Axis 3
Pr.46 Zero point return direction	0 : Positive direction (address increment direction)	0	0	71	221	371
	1 : Negative direction (address decrement direction)	1				
Pr.47 Zero point address	The setting value range differs depending on the "Pr.11 Stepping motor mode selection" or "Pr.1 Unit setting". Here, the value within the [Table 1] range is set. 		0	72 73	222 223	372 373
Pr.48 Zero point return speed	The setting value range differs depending on the "Pr.11 Stepping motor mode selection" or "Pr.1 Unit setting". Here, the value within the [Table 2] range is set. 		1	74 75	224 225	374 375

Pr.46 Zero point return direction

Set the direction to start movement when starting machine zero point return.

0: Positive direction (address increment direction)

Moves in the direction that the address increments. (Arrow 2))

1: Negative direction (address decrement direction)

Moves in the direction that the address decrements. (Arrow 1))

Normally, the zero point is set near the lower limit or the upper limit, so "Pr.46 Zero point return direction" is set as shown below.

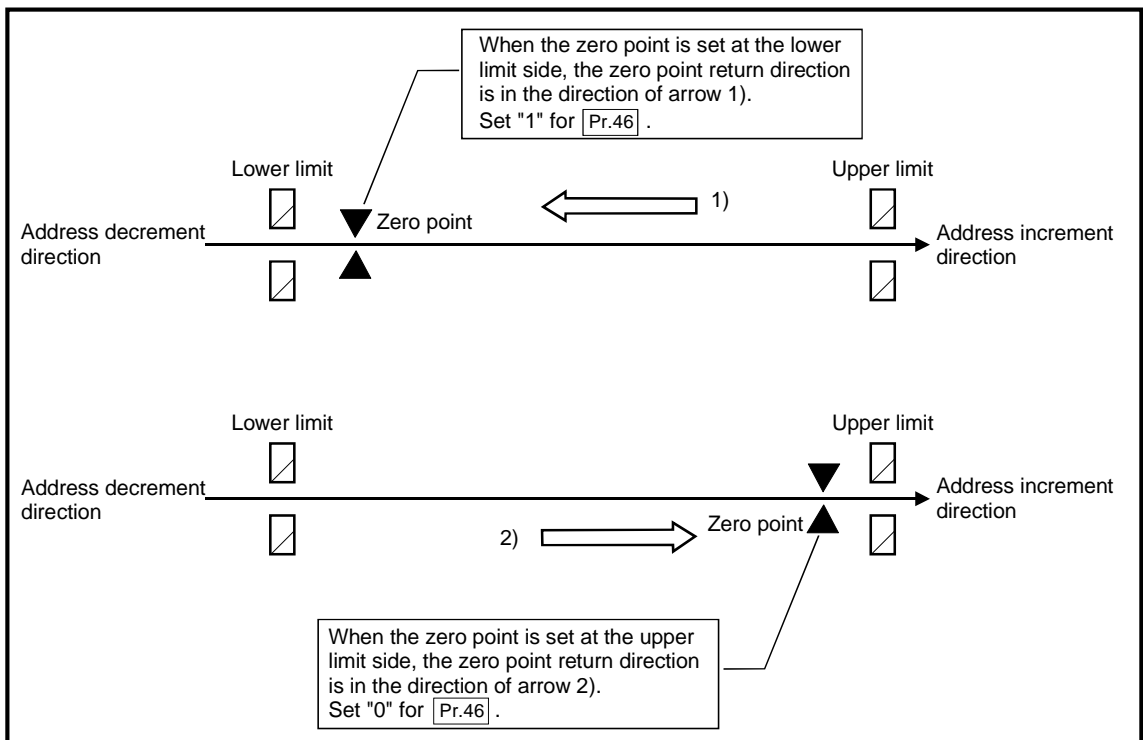

[Table 1]

Pr.11 setting value	Pr.1 setting value	Value set with peripheral device (unit)	Value set with sequence program (unit)
0 : Standard mode	0 : mm	-214748364.8 to 214748364.7 (μm)	-2147483648 to 2147483647 ($\times 10^{-1}\mu\text{m}$)
	1 : inch	-21474.83648 to 21474.83647 (inch)	-2147483648 to 2147483647 ($\times 10^{-5}\text{inch}$)
	2 : degree	0 to 359.99999 (degree)	0 to 35999999 ($\times 10^{-5}\text{degree}$)
	3 : pulse	-2147483648 to 2147483647 (pulse)	-2147483648 to 2147483647 (pulse)
1 : Stepping motor mode	0 : mm	-13421772.8 to 13421772.7 (μm)	-134217728 to 134217727 ($\times 10^{-1}\mu\text{m}$)
	1 : inch	-1342.17728 to 1342.17727 (inch)	-134217728 to 134217727 ($\times 10^{-5}\text{inch}$)
	2 : degree	0 to 359.99999 (degree)	0 to 35999999 ($\times 10^{-5}\text{degree}$)
	3 : pulse	-134217728 to 134217727 (pulse)	-134217728 to 134217727 (pulse)

[Table 2]

Pr.11 setting value	Pr.1 setting value	Value set with peripheral device (unit)	Value set with sequence program (unit)
0 : Standard mode	0 : mm	0.01 to 6000000.00 (mm/min)	1 to 600000000 ($\times 10^{-2}\text{mm/min}$)
	1 : inch	0.001 to 600000.000 (inch/min)	1 to 600000000 ($\times 10^{-3}\text{inch/min}$)
	2 : degree	0.001 to 600000.000 (degree/min)	1 to 600000000 ($\times 10^{-3}\text{degree/min}$)
	3 : pulse	1 to 1000000 (pulse/s)	1 to 1000000 (pulse/s)
1 : Stepping motor mode	0 : mm	0.01 to 375000.00 (mm/min)	1 to 37500000 ($\times 10^{-2}\text{mm/min}$)
	1 : inch	0.001 to 37500.000 (inch/min)	1 to 37500000 ($\times 10^{-3}\text{inch/min}$)
	2 : degree	0.001 to 37500.000 (degree/min)	1 to 37500000 ($\times 10^{-3}\text{degree/min}$)
	3 : pulse	1 to 62500 (pulse/s)	1 to 62500 (pulse/s)

Pr.47 Zero point address

Set the address used as the reference point for positioning control (ABS method). (When the machine zero point return is completed, the stop position address is changed to the address set in "Pr.47 Zero point address". At the same time, the "Pr.47 Zero point address" is stored in "Md.29 Current feed value" and "Md.30 Machine feed value".)

Pr.48 Zero point return speed

Set the speed for zero point return.

Note) Set the "zero point return speed" to less than "Pr.7 Speed limit value". If the "speed limit value" is exceeded, the "zero point return speed" will be limited by "Pr.7 Speed limit value".

Item	Setting value, setting range		Default value	Setting value buffer memory address		
	Value set with peripheral device	Value set with sequence program		Axis 1	Axis 2	Axis 3
Pr.49 Creep speed	The setting value range differs depending on the "Pr.11 Stepping motor mode selection" or "Pr.1 Unit setting". Here, the value within the [Table 1] range is set. 		1	76 77	226 227	376 377
Pr.50 Zero point return retry	0 : Do not retry zero point return with limit switch	0	0	78	228	378
	1 : Retry zero point return with limit switch	1				

Pr.49 Creep speed

Set the creep speed after near-point dog ON (the low speed just before stopping after decelerating from the zero point return speed). The creep speed is set within the following range.

Pr.48 Zero point return speed > Pr.49 Creep speed

Note) The creep speed is related to the detection error when using the zero point return method with zero point signal, and the size of the collision if a collision occurs during zero point return method using the stopper stop method.

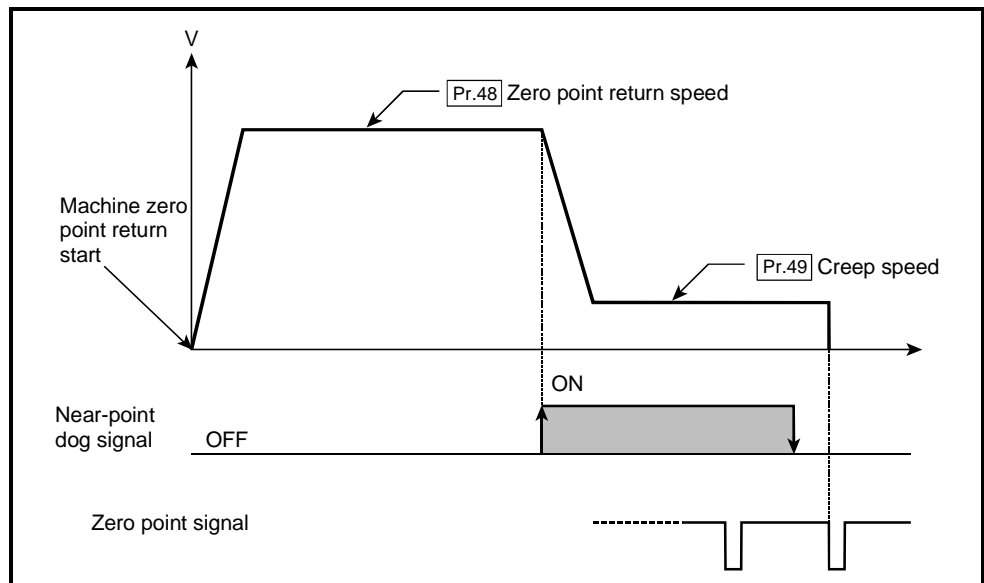

[Table 1]

Pr.11 setting value	Pr.1 setting value	Value set with peripheral device (unit)	Value set with sequence program (unit)
0 : Standard mode	0 : mm	0.01 to 6000000.00 (mm/min)	1 to 600000000 ($\times 10^{-2}$ mm/min)
	1 : inch	0.001 to 600000.000 (inch/min)	1 to 600000000 ($\times 10^{-3}$ inch/min)
	2 : degree	0.001 to 600000.000 (degree/min)	1 to 600000000 ($\times 10^{-3}$ degree/min)
	3 : pulse	1 to 1000000 (pulse/s)	1 to 1000000 (pulse/s)
1 : Stepping motor mode	0 : mm	0.01 to 375000.00 (mm/min)	1 to 37500000 ($\times 10^{-2}$ mm/min)
	1 : inch	0.001 to 37500.000 (inch/min)	1 to 37500000 ($\times 10^{-3}$ inch/min)
	2 : degree	0.001 to 37500.000 (degree/min)	1 to 37500000 ($\times 10^{-3}$ degree/min)
	3 : pulse	1 to 62500 (pulse/s)	1 to 62500 (pulse/s)

Pr.50 Zero point return retry

Set whether to carry out zero point return retry.

When the zero point return retry function is validated and the machine zero point return is started, first the axis will move in the designated zero point return direction (1)). If the upper/lower limit signal turns OFF before the near-point dog signal turns ON is detected (2)), the axis will decelerate to a stop, and then will move in the direction opposite the designated zero point return direction (3)). If it is detected that the near-point dog signal has turned OFF from turning ON while moving in the opposite direction, the axis will decelerate to a stop (4)), and then will carry out machine zero point return again (5), 6)).

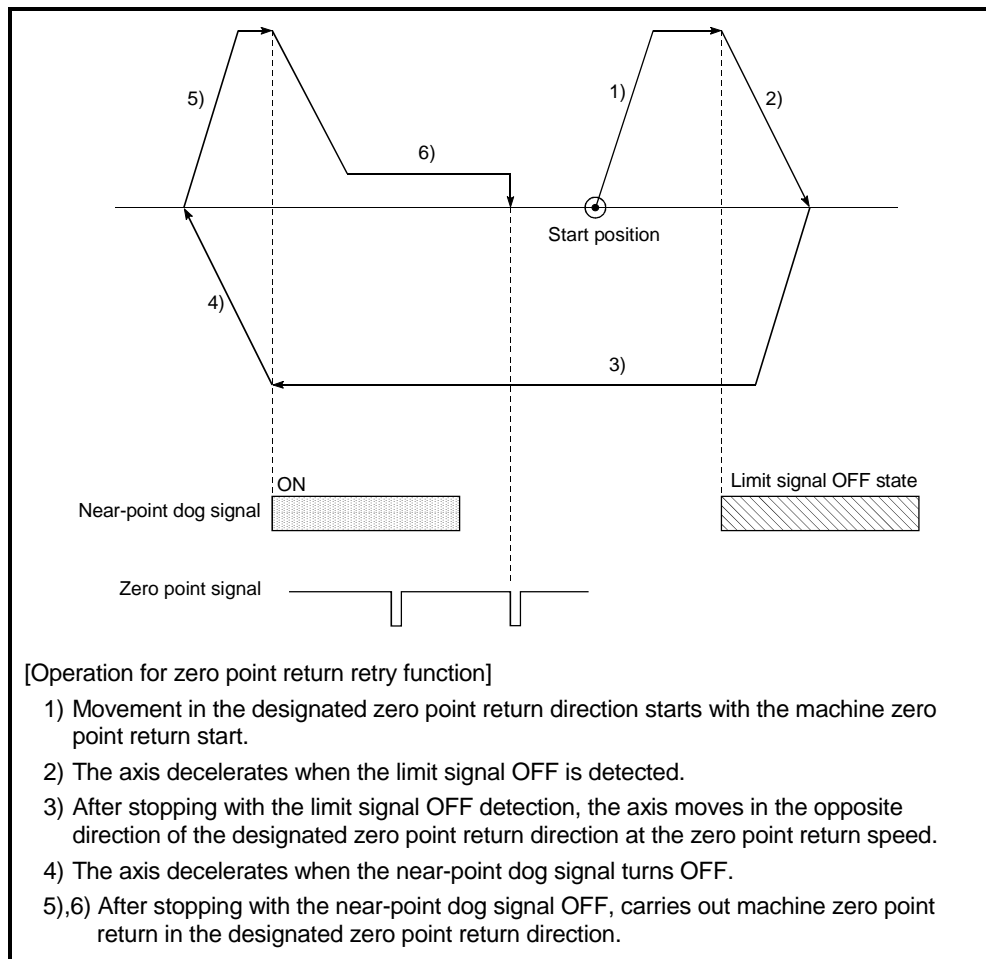

5.2.6 Zero point return detailed parameters

Item	Setting value, setting range		Default value	Setting value buffer memory address		
	Value set with peripheral device	Value set with sequence program		Axis 1	Axis 2	Axis 3
Pr.51 Zero point return dwell time	0 to 65535 (ms)	0 to 65535 (ms) 0 to 32767 : Set as a decimal 32768 to 65535 : Convert into hexadecimal and set	0	79	229	379
Pr.52 Setting for the movement amount after near-point dog ON	The setting value range differs depending on the " Pr.11 Stepping motor mode selection" or " Pr.1 Unit setting". Here, the value within the [Table 1] range is set. 		0	80 81	230 231	380 381
Pr.53 Zero point return acceleration time selection	0 : Pr.8 Acceleration time 0	0	0	82	232	382
	1 : Pr.26 Acceleration time 1	1				
	2 : Pr.27 Acceleration time 2	2				
	3 : Pr.28 Acceleration time 3	3				
Pr.54 Zero point return deceleration time selection	0 : Pr.9 Deceleration time 0	0	0	83	233	383
	1 : Pr.29 Deceleration time 1	1				
	2 : Pr.30 Deceleration time 2	2				
	3 : Pr.31 Deceleration time 3	3				

Pr.51 Zero point return dwell time

When stopper stop 1) is set for "**Pr.45** Zero point return method", set the time for the machine zero point return to complete after the near-point dog signal turns ON. The setting value must be longer than the movement time from the near-point dog signal ON to stopping with the stopper.
(If the zero point return method is not "stopper stop method 1)", the "**Pr.51** Zero point return dwell time" value is irrelevant.)

Pr.52 Setting for the movement amount after near-point dog ON

When zero point return method is set the count method 1) or 2), set the movement amount to the zero point after the near-point dog signal turns ON.
(The movement amount after near-point dog ON should be equal to greater than the sum of the "distance covered by the deceleration from the zero point return speed to the creep speed" and "distance of movement in 10 ms at the zero point return speed".)

[Table 1]

Pr.11 setting value	Pr.1 setting value	Value set with peripheral device (unit)	Value set with sequence program (unit)
0 : Standard mode	0 : mm	0 to 214748364.7 (μm)	0 to 2147483647 (×10 ⁻¹ μm)
	1 : inch	0 to 21474.83647 (inch)	0 to 2147483647 (×10 ⁻⁵ inch)
	2 : degree	0 to 21474.83647 (degree)	0 to 2147483647 (×10 ⁻⁵ degree)
	3 : pulse	0 to 2147483647 (pulse)	0 to 2147483647 (pulse)
1 : Stepping motor mode	0 : mm	0 to 13421772.7 (μm)	0 to 134217727 (×10 ⁻¹ μm)
	1 : inch	0 to 1342.17727 (inch)	0 to 134217727 (×10 ⁻⁵ inch)
	2 : degree	0 to 1342.17727 (degree)	0 to 134217727 (×10 ⁻⁵ degree)
	3 : pulse	0 to 134217727 (pulse)	0 to 134217727 (pulse)

Example for setting "Pr.52 Setting for the movement amount after near-point dog ON"

When "Pr.7 Speed limit value" is set to 200kpulse/s, "Pr.48 Zero point return speed" is set to 10kpulse/s, "Pr.49 Creep speed" is set to 1kpulse/s and the deceleration time is set to 300ms, "Pr.52 Setting for the movement amount after near-point dog ON" is calculated as shown below.

[Machine zero point return operation]

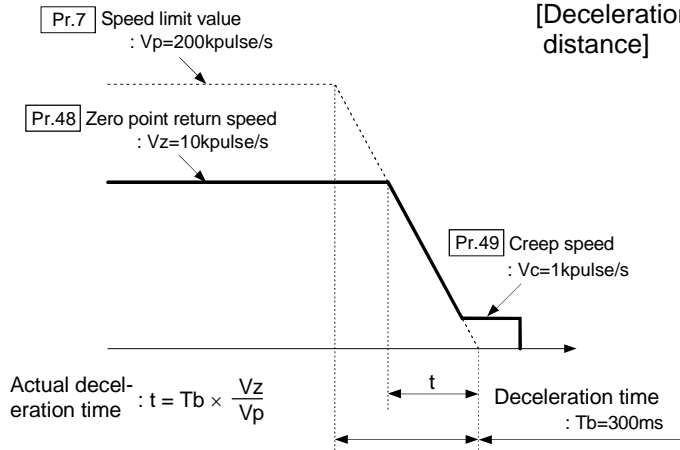

$$\begin{aligned}
 \text{[Deceleration distance]} &= \frac{1}{2} \times \frac{V_z}{1000} \times t + \underbrace{0.01 \times V_z}_{\text{Movement amount for 10ms at zero point return speed}} \\
 &= \frac{V_z}{2000} \times \frac{T_b \times V_z}{V_p} + 0.01 \times V_z \\
 &= \frac{10 \times 10^3}{2000} \times \frac{300 \times 10 \times 10^3}{200 \times 10^3} + 0.01 \times 10 \times 10^3 \\
 &= 75 + 100 \\
 &= 175 \\
 &\downarrow \\
 &\text{Set 175 or more for "Pr.52 Setting for the movement amount after near-point dog ON"}
 \end{aligned}$$

Pr.53 Zero point return acceleration time selection

Set which of "acceleration time 0 to 3" to use for the acceleration time during zero point return.

- 0 : Use the value set in "Pr.8 Acceleration time 0".
- 1 : Use the value set in "Pr.26 Acceleration time 1".
- 2 : Use the value set in "Pr.27 Acceleration time 2".
- 3 : Use the value set in "Pr.28 Acceleration time 3".

Pr.54 Zero point return deceleration time selection

Set which of deceleration time 0 to 3" to use for the deceleration time during zero point return.

- 0 : Use the value set in "Pr.9 Deceleration time 0".
- 1 : Use the value set in "Pr.29 Deceleration time 1".
- 2 : Use the value set in "Pr.30 Deceleration time 2".
- 3 : Use the value set in "Pr.31 Deceleration time 3".

Item	Setting value, setting range		Default value	Setting value buffer memory address		
	Value set with peripheral device	Value set with sequence program		Axis 1	Axis 2	Axis 3
Pr.55 Zero point shift amount	The setting value range differs depending on the " Pr.11 Stepping motor mode selection" or " Pr.1 Unit setting". Here, the value within the [Table 1] range is set. <div style="border: 1px solid black; padding: 5px; display: inline-block;"> [Table 1] on right page </div>		0	84 85	234 235	384 385
Pr.56 Zero point return torque limit value	1 to 300 (%)	1 to 300 (%)	300	86	236	386
Pr.57 Speed designation during zero point shift	0 : Zero point return speed 1 : Creep speed	0 1	0	88	238	388
Pr.58 Dwell time during zero point return retry	0 to 65535 (ms)	0 to 65535 (ms) 0 to 32767 : Set as a decimal 32768 to 65535 : Convert into hexadecimal and set	0	89	239	389

Pr.55 Zero point shift amount

Set the amount to shift (move) from the position stopped at with machine zero point return.

* The zero point shift function is used to compensate the zero point position stopped at with machine zero point return.

If there is a physical limit to the zero point position, due to the relation of the near-point dog installation position, use this function to compensate the zero point to an optimum position.

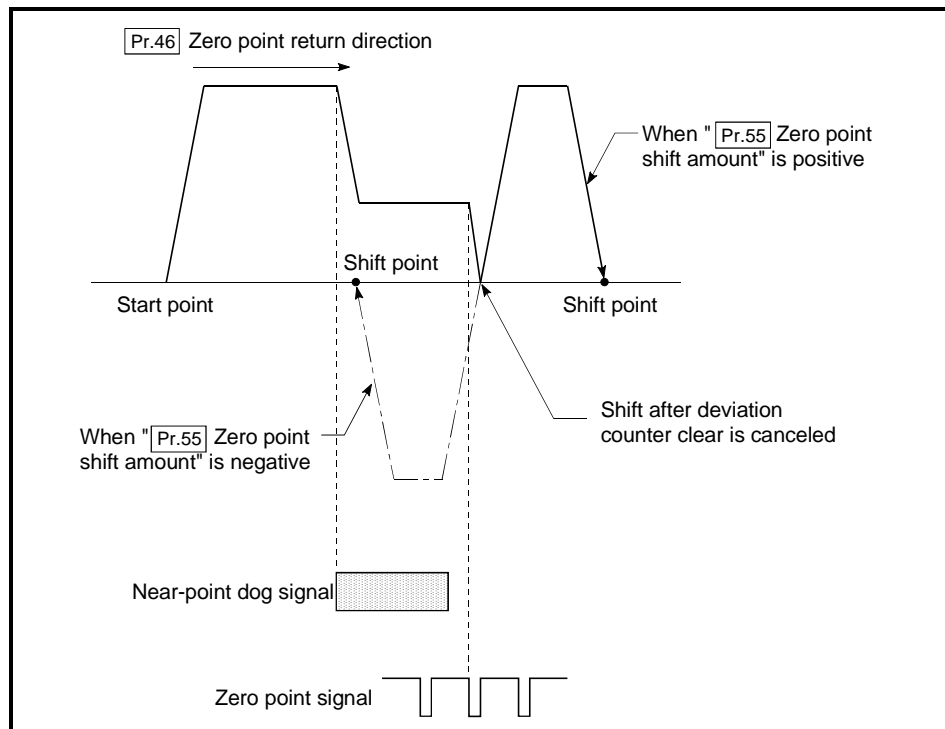

[Table 1]

Pr.11 setting value	Pr.1 setting value	Value set with peripheral device (unit)	Value set with sequence program (unit)
0 : Standard mode	0 : mm	-214748364.8 to 214748364.7 (μm)	-2147483648 to 2147483647 (×10 ⁻¹ μm)
	1 : inch	-21474.83648 to 21474.83647 (inch)	-2147483648 to 2147483647 (×10 ⁻⁵ inch)
	2 : degree	-21474.83648 to 21474.83647 (degree)	-2147483648 to 2147483647 (×10 ⁻⁵ degree)
	3 : pulse	-2147483648 to 2147483647 (pulse)	-2147483648 to 2147483647 (pulse)
1 : Stepping motor mode	0 : mm	-13421772.8 to 13421772.7 (μm)	-134217728 to 134217727 (×10 ⁻¹ μm)
	1 : inch	-1342.17728 to 1342.17727 (inch)	-134217728 to 134217727 (×10 ⁻⁵ inch)
	2 : degree	-1342.17728 to 1342.17727 (degree)	-134217728 to 134217727 (×10 ⁻⁵ degree)
	3 : pulse	-134217728 to 134217727 (pulse)	-134217728 to 134217727 (pulse)

Pr.56 Zero point return torque limit value

Set the value to limit the servomotor torque after reaching the creep speed during machine zero point return.

Refer to section "12.4.2 Torque limit function" for details on the torque limits.

Pr.57 Speed designation during zero point shift

Set the operation speed for when a value other than "0" is set for "Pr.55 Zero point shift amount". Select the setting from "Pr.48 Zero point return speed" or "Pr.49 Creep speed".

0 : Designate "Pr.48 Zero point return speed" as the setting value.

1 : Designate "Pr.49 Creep speed" as the setting value.

Pr.58 Dwell time during zero point return retry

When zero point return retry is validated (when "1" is set for Pr.50), set the stop time after decelerating in 2) and 4) in the following drawing.

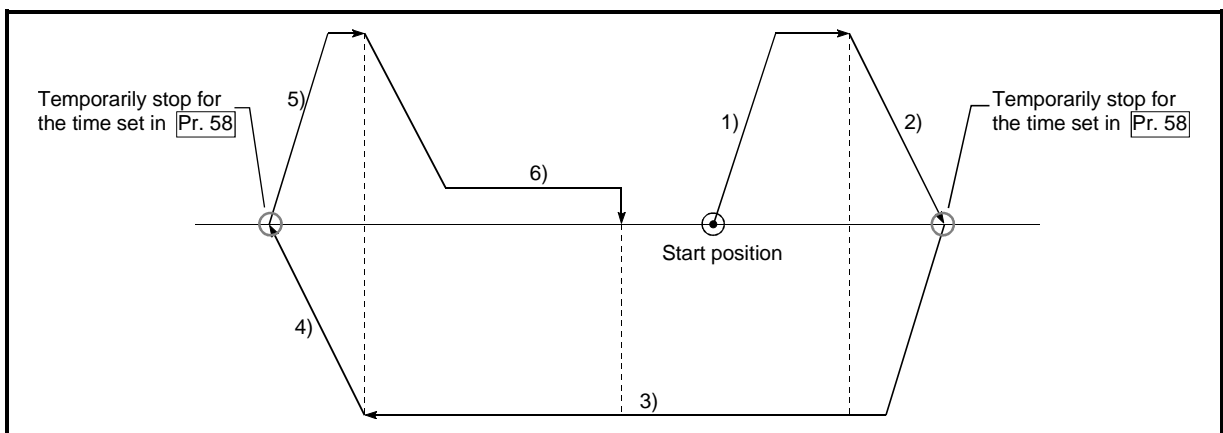

5.3 List of positioning data

Before explaining the positioning data setting items [Da.1] to [Da.9], the configuration of the positioning data will be shown below.

The positioning data stored in the AD75 buffer memory has the following type of configuration.

Positioning data No.	1			2			3			...			99			100 *		
	Positioning identifier [Da.1] to [Da.4]	1300	1310	1320	1300	1310	1320	1300	1310	1320	...	1300	1310	1320	2280	2290		
[Da.9] M code	1301	1311	1321	1301	1311	1321	1301	1311	1321	...	1301	1311	1321	2281	2291			
[Da.8] Dwell time	1302	1312	1322	1302	1312	1322	1302	1312	1322	...	1302	1312	1322	2282	2292			
[Da.7] Command speed	1304 1305	1314 1315	1324 1325	1304 1305	1314 1315	1324 1325	1304 1305	1314 1315	1324 1325	...	1304 1305	1314 1315	1324 1325	2284 2285	2294 2295			
[Da.5] Positioning address/movement amount	1306 1307	1316 1317	1326 1327	1306 1307	1316 1317	1326 1327	1306 1307	1316 1317	1326 1327	...	1306 1307	1316 1317	1326 1327	2286 2287	2296 2297			
[Da.6] Arc address	1308 1309	1318 1319	1328 1329	1308 1309	1318 1319	1328 1329	1308 1309	1318 1319	1328 1329	...	1308 1309	1318 1319	1328 1329	2288 2289	2298 2299			

- Up to 100 positioning data items can be set (stored) for each axis in the buffer memory address shown on the left. This data is controlled as positioning data No. 1 to 100 for each axis.
- One positioning data item is configured of the items shown in the bold box.

Positioning data No.	1			2			3			...			99			100 *		
	Positioning identifier [Da.1] to [Da.4]	2300	2310	2320	2300	2310	2320	2300	2310	2320	...	2300	2310	2320	3280	3290		
[Da.9] M code	2301	2311	2321	2301	2311	2321	2301	2311	2321	...	2301	2311	2321	3281	3291			
[Da.8] Dwell time	2302	2312	2322	2302	2312	2322	2302	2312	2322	...	2302	2312	2322	3282	3292			
[Da.7] Command speed	2304 2305	2314 2315	2324 2325	2304 2305	2314 2315	2324 2325	2304 2305	2314 2315	2324 2325	...	2304 2305	2314 2315	2324 2325	3284 3285	3294 3295			
[Da.5] Positioning address/movement amount	2306 2307	2316 2317	2326 2327	2306 2307	2316 2317	2326 2327	2306 2307	2316 2317	2326 2327	...	2306 2307	2316 2317	2326 2327	3286 3287	3296 3297			
[Da.6] Arc address	2308 2309	2318 2319	2328 2329	2308 2309	2318 2319	2328 2329	2308 2309	2318 2319	2328 2329	...	2308 2309	2318 2319	2328 2329	3288 3289	3298 3299			

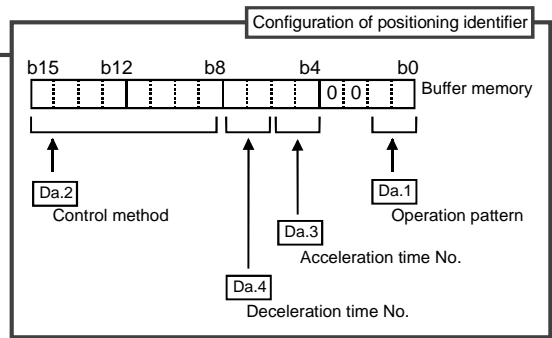

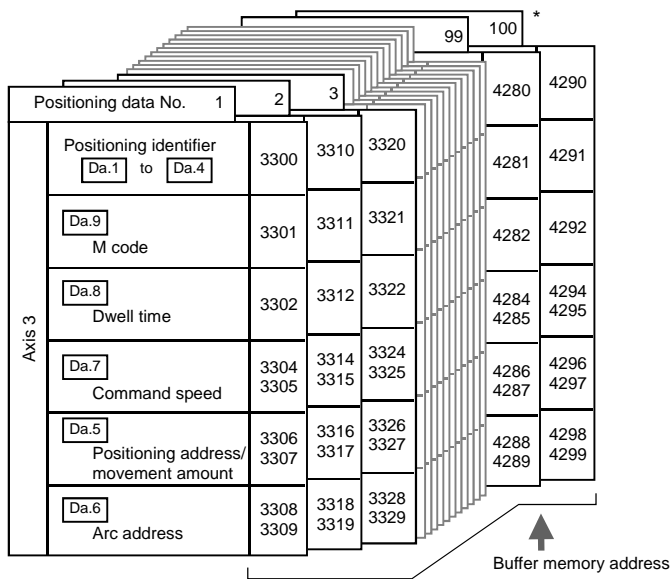

Da.

The positioning data setting items (Da.1 to Da.9) are explained in the following section.
 (The buffer memory addresses for the axis 1 to axis 3 "positioning data No. 1" are shown.)

REMARK

*: Positioning data No. 101 to 600 cannot be set in the buffer memory.
 The data set in positioning data No. 101 to 600 is directly set into the AD75 OS memory from a peripheral device using the AD75 software package.
 (To set without using a peripheral device, transmission must be carried out using the block transmission memory.)

Item	Setting value		Default value	Setting value buffer memory address				
	Value set with peripheral device	Value set with sequence program		Axis 1	Axis 2	Axis 3		
Positioning identifier	Da.1 Operation pattern	00 : Positioning complete	00		0000H	1300	2300	3300
		01 : Continuous positioning control	01					
		11 : Continuous path control	11					
	Da.2 Control method	ABS Linear 1 : 1-axis linear control (ABS)	01H					
		INC Linear 1 : 1-axis linear control (INC)	02H					
		Fixed-dimension feed 1 : 1-axis fixed-dimension feed control	03H					
		ABS Linear 2 : 2-axis linear interpolation control (ABS)	04H					
		INC Linear 2 : 2-axis linear interpolation control (INC)	05H					
		Fixed-dimension feed 2 : 2-axis fixed-dimension feed control	06H					
		ABS Circular interpolation : Circular interpolation control with auxiliary point designation (ABS)	07H					
		INC Circular interpolation : Circular interpolation control with auxiliary point designation (INC)	08H					
		ABS Circular right : Circular interpolation control with center point designation (ABS, CW)	09H					
		ABS Circular left : Circular interpolation control with center point designation (ABS, CCW)	0AH					
		INC Circular right : Circular interpolation control with center point designation (INC, CW)	0BH					
		INC Circular left : Circular interpolation control with center point designation (INC, CCW)	0CH					
		Forward run Speed limited : Speed control (forward run)	0DH					
		Reverse run Speed limited : Speed control (reverse run)	0EH					
		Forward run speed/position : Speed/position changeover control (forward run)	0FH					
		Reverse run speed/position : Speed/position changeover control (reverse run)	10H					
		Current value change : Current value change	11H					
		JUMP command : JUMP command	20H					
		Da.3 Acceleration time No.	0 : Pr.8 Acceleration time 0					
	1 : Pr.26 Acceleration time 1		01					
	2 : Pr.27 Acceleration time 2		10					
	3 : Pr.28 Acceleration time 3		11					
	Da.4 Deceleration time No.	0 : Pr.9 Deceleration time 0	00					
		1 : Pr.29 Deceleration time 1	01					
		2 : Pr.30 Deceleration time 2	10					
3 : Pr.31 Deceleration time 3		11						

Da.1 Operation pattern

The operation pattern designates whether positioning of a certain data No. is to be ended with just that data, or whether the positioning for the next data No. is to be carried out in succession.

[Operation pattern]

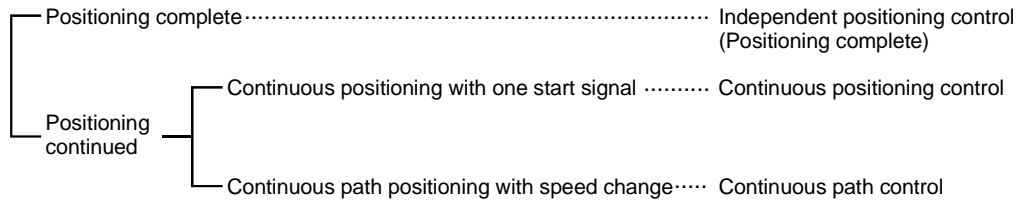

- 1) Positioning complete..... Set to execute positioning to the designated address, and then complete positioning.
- 2) Continuous positioning control Positioning is carried out successively in order of data Nos. with one start signal. The operation stops once at each positioning data.
- 3) Continuous path control..... Positioning is carried out successively in order of data Nos. with one start signal. The operation does not stop at each positioning data.

Da.2 Control method

Set the "control method" for carrying out positioning control.

- Note)
- When "JUMP command" is set for the control method, the "**Da.8** Dwell time" and "**Da.9** M code" setting details will differ.
 - Refer to "Chapter 9 MAIN POSITIONING CONTROL" for details on the control methods.
 - If "degree" is set for "**Pr.1** Unit setting", circular interpolation control cannot be carried out. (The "Control method setting error" (error code: 524) will occur when executed.)

Da.3 Acceleration time No.

Set which of "acceleration time 0 to 3" to use for the acceleration time during positioning.

- 0 : Use the value set in "**Pr.8** Acceleration time 0".
- 1 : Use the value set in "**Pr.26** Acceleration time 1".
- 2 : Use the value set in "**Pr.27** Acceleration time 2".
- 3 : Use the value set in "**Pr.28** Acceleration time 3".

Da.4 Deceleration time No.

Set which of "deceleration time 0 to 3" to use for the deceleration time during positioning.

- 0 : Use the value set in "**Pr.9** Deceleration time 0".
- 1 : Use the value set in "**Pr.29** Deceleration time 1".
- 2 : Use the value set in "**Pr.30** Deceleration time 2".
- 3 : Use the value set in "**Pr.31** Deceleration time 3".

Item	Setting value, setting range		Default value	Setting value buffer memory address		
	Value set with peripheral device	Value set with sequence program		Axis 1	Axis 2	Axis 3
Da.5 Positioning address/movement amount	The setting value range differs according to the "Da.2 Control method". Here, the value within the following range of [Table 1] range is set. <div style="border: 1px solid black; padding: 5px; display: inline-block;"> [Table 1] on right page </div>		0	1306 1307	2306 2307	3306 3307

Da.5 Positioning address/movement amount

Set the address to be used as the target value for positioning control. The setting value range differs according to the "Da.2 Control method". ((1) to (3))

(1) Absolute (ABS) system, Current value charge

- The setting value (positioning address) for the ABS system and current value change is set with an absolute address (address from zero point).

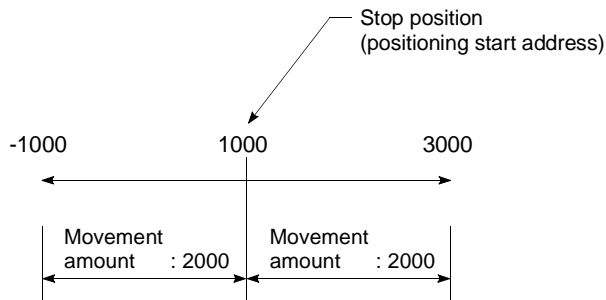

(2) Incremental (INC) system, fixed-dimension feed 1, fixed-dimension feed 2

- The setting value (movement amount) for the INC system is set as a movement amount with sign.
 When movement amount is positive: Moves in the positive direction (address increment direction)
 When movement amount is negative: Moves in the negative direction (address decrement direction)

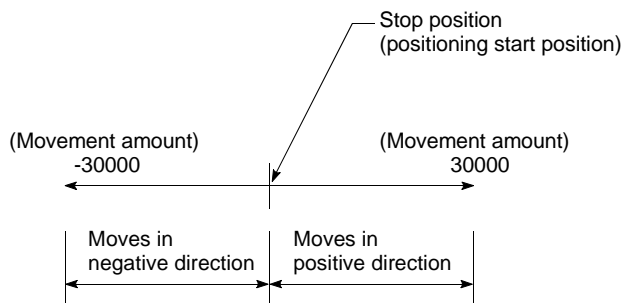

[Table 1]

■ When "Pr.1" Unit setting" is "mm"

Da.2 setting value	Value set with peripheral device (μm)	Value set with sequence program *1 ($\times 10^{-1}\mu\text{m}$)
ABS Linear 1 : 01H ABS Linear 2 : 04H Current value change : 11H	◇ Set the address -214748364.8 to 214748364.7 *2 [-13421772.8 to 13421772.7] *3	◇ Set the address -2147483648 to 2147483647 [-134217728 to 134217727]
INC Linear 1 : 02H INC Linear 2 : 05H Fixed-dimension feed 1 : 03H Fixed dimension feed 2 : 06H	◇ Set the movement amount -214748364.8 to 214748364.7 [-13421772.8 to 13421772.7]	◇ Set the movement amount -2147483648 to 2147483647 [-134217728 to 134217727]
Forward run speed/position : 0FH Reverse run speed/position : 10H	◇ Set the movement amount 0 to 214748364.7 [0 to 13421772.7]	◇ Set the movement amount 0 to 2147483647 [0 to 134217727]
Forward run Speed control : 0DH Reverse run Speed control : 0EH JUMP command : 20H	(Setting not required)	(Setting not required)
ABS Circular interpolation : 07H ABS Circular right : 09H ABS Circular left : 0AH	◇ Set the address -214748364.8 to 214748364.7 * Circular interpolation control is not possible when using the stepping motor mode.	◇ Set the address -2147483648 to 2147483647
INC Circular interpolation : 08H INC Circular right : 0BH INC Circular left : 0CH	◇ Set the movement amount -214748364.8 to 214748364.7 * Circular interpolation control is not possible when using the stepping motor mode.	◇ Set the movement amount -2147483648 to 2147483647

*1 Decimal points cannot be used in the sequence program, so input the setting value as an integer.
(The value will be converted into the specified value within the system.)

*2 Setting range for when "Pr.11 Stepping motor mode selection" is "standard mode".

*3 The values shown in parentheses are the setting range for when "Pr.11 Stepping motor mode selection" is "stepping motor mode".

(3) For speed/position changeover control

- Set the movement amount from when the control changes from the speed control to the position control.

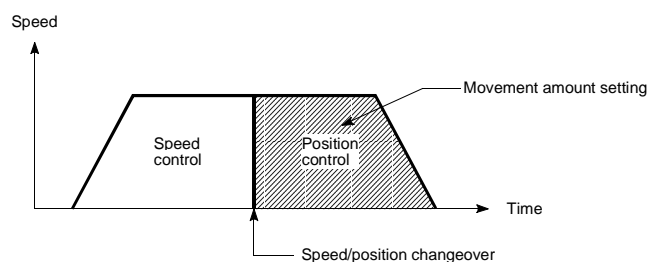

■ When " Pr.1 Unit setting" is "degree"

Da.2 setting value	Value set with peripheral device (degree)	Value set with sequence program *1 ($\times 10^{-5}$ degree)
ABS Linear 1 : 01H ABS Linear 2 : 04H Current value change : 11H	◇ Set the address 0 to 359.99999 *2 [0 to 359.99999] *3	◇ Set the address 0 to 35999999 [0 to 35999999]
INC Linear 1 : 02H INC Linear 2 : 05H Fixed-dimension feed 1 : 03H Fixed-dimension feed 2 : 06H	◇ Set the movement amount -21474.83648 to 21474.83647 [-1342.17728 to 1342.17727]	◇ Set the movement amount -2147483648 to 2147483647 [-134217728 to 134217727]
Forward run speed/position : 0FH Reverse run speed/position : 10H	◇ Set the movement amount 0 to 21474.83647 [0 to 1342.17727]	◇ Set the movement amount 0 to 2147483647 [0 to 134217727]
Forward run Speed control : 0DH Reverse run Speed control : 0EH JUMP command : 12H	(Setting not required)	(Setting not required)
ABS Circular interpolation : 07H ABS Circular right : 09H ABS Circular left : 0AH INC Circular interpolation : 08H INC Circular right : 0BH INC Circular left : 0CH	Circular interpolation control is not possible	

■ When " Pr.1 Unit setting" is "pulse"

Da.2 setting value	Value set with peripheral device (pulse)	Value set with sequence program *1 (pulse)
ABS Linear 1 : 01H ABS Linear 2 : 04H Current value change : 11H	◇ Set the address -2147483648 to 2147483647 *2 [-134217728 to 134217727] *3	◇ Set the address -2147483648 to 2147483647 [-134217728 to 134217727]
INC Linear 1 : 02H INC Linear 2 : 05H Fixed-dimension feed 1 : 03H Fixed-dimension feed 2 : 06H	◇ Set the movement amount -2147483648 to 2147483647 [-134217728 to 134217727]	◇ Set the movement amount -2147483648 to 2147483647 [-134217728 to 134217727]
Forward run speed/position : 0FH Reverse run speed/position : 10H	◇ Set the movement amount 0 to 2147483647 [0 to 134217727]	◇ Set the movement amount 0 to 2147483647 [0 to 134217727]
Forward run Speed control : 0DH Reverse run Speed control : 0EH JUMP command : 20H	(Setting not required)	(Setting not required)
ABS Circular interpolation : 07H ABS Circular right : 09H ABS Circular left : 0AH	◇ Set the address -2147483648 to 2147483647 * Circular interpolation control is not possible when using the stepping motor mode.	◇ Set the address -2147483648 to 2147483647
INC Circular interpolation : 08H INC Circular right : 0BH INC Circular left : 0CH	◇ Set the movement amount -2147483648 to 2147483647 * Circular interpolation control is not possible when using the stepping motor mode.	◇ Set the movement amount -2147483648 to 2147483647

■ When "Pr.1 Unit setting" is "inch"

Da.2 setting value	Value set with peripheral device (inch)	Value set with sequence program *1 ($\times 10^{-5}$ inch)
ABS Linear 1 : 01H ABS Linear 2 : 04H Current value change : 11H	◇ Set the address -21474.83648 to 21474.83647 *2 [-1342.17728 to 1342.17727] *3	◇ Set the address -2147483648 to 2147483647 [-134217728 to 134217727]
INC Linear 1 : 02H INC Linear 2 : 05H Fixed-dimension feed 1 : 03H Fixed-dimension feed 2 : 06H	◇ Set the movement amount -21474.83648 to 21474.83647 [-1342.17728 to 1342.17727]	◇ Set the movement amount -2147483648 to 2147483647 [-134217728 to 134217727]
Forward run speed/position : 0FH Reverse run speed/position : 10H	◇ Set the movement amount 0 to 21474.83647 [0 to 1342.17727]	◇ Set the movement amount 0 to 2147483647 [0 to 134217727]
Forward run Speed control : 0DH Reverse run Speed control : 0EH JUMP command : 20H	(Setting not required)	(Setting not required)
ABS Circular interpolation : 07H ABS Circular right : 09H ABS Circular left : 0AH	◇ Set the address -21474.83648 to 21474.83647 * Circular interpolation control is not possible when using the stepping motor mode.	◇ Set the address -2147483648 to 2147483647
INC Circular interpolation : 08H INC Circular right : 0BH INC Circular left : 0CH	◇ Set the movement amount -21474.83648 to 21474.83647 * Circular interpolation control is not possible when using the stepping motor mode.	◇ Set the movement amount -2147483648 to 2147483647

*1 Decimal points cannot be used in the sequence program, so input the setting value as an integer.
(The value will be converted into the specified value within the system.)

*2 Setting range for when "Pr.11 Stepping motor mode selection" is "standard mode".

*3 The values shown in parentheses are the setting range for when "Pr.11 Stepping motor mode selection" is "stepping motor mode".

Item	Setting value, setting range		Default value	Setting value buffer memory address		
	Value set with peripheral device	Value set with sequence program		Axis 1	Axis 2	Axis 3
Da.6 Arc address	The setting value range differs according to the "Da.2 Control method". Here, the value within the [Table 1] range is set. <div style="border: 1px solid gray; padding: 5px; display: inline-block;"> [Table 1] on right page </div>		0	1308 1309	2308 2309	3308 3309

Da.6 Arc address

The arc address is data required only when carrying out circular interpolation control.

- (1) When carrying out circular interpolation with auxiliary point designation, set the auxiliary point (passing point) address as the arc address.
- (2) When carrying out circular interpolation with center point designation, set the center point address of the arc as the arc address.

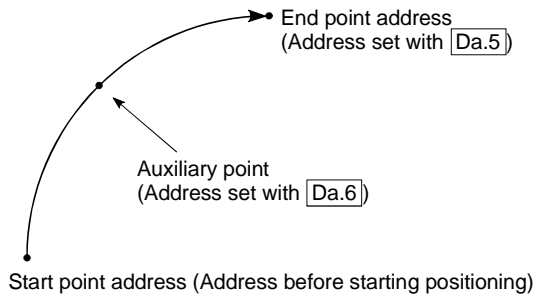

<(1) Circular interpolation with auxiliary point designation>

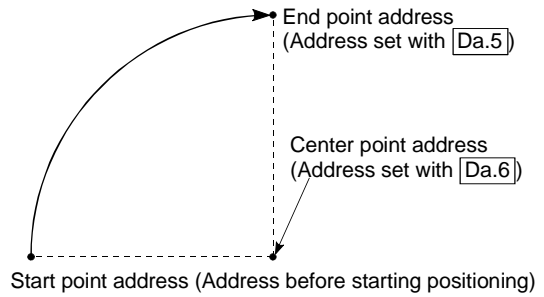

<(2) Circular interpolation with center point designation>

When not carrying out circular interpolation control, the value set in "Da.6 Arc address" will be invalid.

[Table 1]

■ When "Pr.1 Unit setting" is "mm"

Da.2 setting value	Value set with peripheral device (μm)	Value set with sequence program *1 ($\times 10^{-1}\mu\text{m}$)
ABS Circular interpolation : 07H ABS Circular right : 09H ABS Circular left : 0AH	◇ Set the address -214748364.8 to 214748364.7 *2	◇ Set the address -2147483648 to 2147483647
INC Circular interpolation : 08H INC Circular right : 0BH INC Circular left : 0CH	◇ Set the movement amount -214748364.8 to 214748364.7	◇ Set the movement amount -2147483648 to 2147483647
ABS Linear 1 : 01H ABS Linear 2 : 04H INC Linear 1 : 02H INC Linear 2 : 05H Fixed-dimension feed 1 : 03H Fixed-dimension feed 2 : 06H Forward run Speed control : 0DH Reverse run Speed control : 0EH Forward run speed/position : 0FH Reverse run speed/position : 10H JUMP command : 20H Current value change : 11H	(Setting not required)	(Setting not required)

*1 Decimal points cannot be used in the sequence program, so input the setting value as an integer.
(The value will be converted into the specified value within the system.)

*2 Setting range for when "Pr.11 Stepping motor mode selection" is "standard mode".
(Circular interpolation control cannot be carried out when using the stepping motor.)

■ When "Pr.1 Unit setting" is "degree"

Da.2 setting value	Value set with peripheral device (degree)	Value set with sequence program *1 ($\times 10^{-5}$ degree)
ABS Circular interpolation : 07H ABS Circular right : 09H ABS Circular left : 0AH	Circular interpolation control is not possible (If set, an error occurs.)	
INC Circular interpolation : 08H INC Circular right : 0BH INC Circular left : 0CH		
ABS Linear 1 : 01H ABS Linear 2 : 04H INC Linear 1 : 02H INC Linear 2 : 05H Fixed-dimension feed 1 : 03H Fixed-dimension feed 2 : 06H Forward run Speed control : 0DH Reverse run Speed control : 0EH Forward run speed/position : 0FH Reverse run speed/position : 10H JUMP command : 20H Current value change : 11H		

■ When "Pr.1 Unit setting" is "pulse"

Da.2 setting value	Value set with peripheral device (pulse)	Value set with sequence program *1 (pulse)
ABS Circular interpolation : 07H ABS Circular right : 09H ABS Circular left : 0AH	◇ Set the address -2147483648 to 2147483647 *2	◇ Set the address -2147483648 to 2147483647
INC Circular interpolation : 08H INC Circular right : 0BH INC Circular left : 0CH	◇ Set the movement amount -2147483648 to 2147483647	◇ Set the movement amount -2147483648 to 2147483647
ABS Linear 1 : 01H ABS Linear 2 : 04H INC Linear 1 : 02H INC Linear 2 : 05H Fixed-dimension feed 1 : 03H Fixed-dimension feed 2 : 06H Forward run Speed control : 0DH Reverse run Speed control : 0EH Forward run speed/position : 0FH Reverse run speed/position : 10H JUMP command : 20H Current value change : 11H	(Setting not required)	(Setting not required)

*1 Decimal points cannot be used in the sequence program, so input the setting value as an integer.
(The value will be converted into the specified value within the system.)

*2 Setting range for when "Pr.11 Stepping motor mode selection" is "standard mode".
(Circular interpolation control cannot be carried out when using the stepping motor.)

■ When "Pr.1 Unit setting" is "inch"

Da.2 setting value	Value set with peripheral device (inch)	Value set with sequence program *1 ($\times 10^{-5}$ inch)
ABS Circular interpolation : 07H ABS Circular right : 09H ABS Circular left : 0AH	◇ Set the address -21474.83648 to 21474.83647 *2	◇ Set the address -2147483648 to 2147483647
INC Circular interpolation : 08H INC Circular right : 0BH INC Circular left : 0CH	◇ Set the movement amount -21474.83648 to 21474.83647	◇ Set the movement amount -2147483648 to 2147483647
ABS Linear 1 : 01H ABS Linear 2 : 04H INC Linear 1 : 02H INC Linear 2 : 05H Fixed-dimension feed 1 : 03H Fixed-dimension feed 2 : 06H Forward run Speed control : 0DH Reverse run Speed control : 0EH Forward run speed/position : 0FH Reverse run speed/position : 10H JUMP command : 20H Current value range : 11H	(Setting not required)	(Setting not required)

*1 Decimal points cannot be used in the sequence program, so input the setting value as an integer.
(The value will be converted into the specified value within the system.)

*2 Setting range for when "Pr.11 Stepping motor mode selection" is "standard mode".
(Circular interpolation control cannot be carried out when using the stepping motor.)

Item	Setting value, setting range		Default value	Setting value buffer memory address		
	Value set with peripheral device	Value set with sequence program		Axis 1	Axis 2	Axis 3
Da.7 Command speed	The setting value range differs depending on the "Pr.11 Stepping motor mode selection" or "Pr.1 Unit setting". Here, the value within the [Table 1] range is set. <div style="text-align: center; border: 1px solid black; padding: 5px; margin: 10px 0;"> [Table 1] on right page </div>		0	1304	2304	3306
	-1: Current speed (Speed set for previous positioning data No.) <div style="text-align: center; border: 1px solid black; padding: 5px; margin: 10px 0;"> -1 </div>			1305	2305	3307
Da.8 Dwell time/ JUMP destination positioning data No.	Dwell time	The setting value range differs according to the "Da.2 Control method". Here, the value within the [Table 2] range is set. <div style="text-align: center; border: 1px solid black; padding: 5px; margin: 10px 0;"> [Table 2] on right page </div>	0	1302	2302	3302
	JUMP destination positioning data No.					
Da.9 M code	M code	The setting value range differs according to the "Da.2 Control method". Here, the value within the [Table 3] range is set. <div style="text-align: center; border: 1px solid black; padding: 5px; margin: 10px 0;"> [Table 3] on right page </div>	0	1301	2301	3301
	Condition data No.					

Da.7 Command speed

Set the command speed for positioning.

- (1) If the set command speed exceeds the speed limit value, positioning will be carried out at the speed limit value.
- (2) If "-1" is set for the command speed, the current speed (speed set for previous positioning data No.) will be used for positioning control. Use the current speed for uniform speed control, etc. If "-1" is set for continuing positioning data, and the speed is changed, the following speed will also change.

(Note that when starting positioning, if the "-1" speed is set for the positioning data that carries out positioning control first, the error "no command speed" (error code:503) will occur, and the positioning will not start. Refer to section "14.2 List of errors" for details on the errors.)

Da.9 M code (condition data No.)

Set an "M code" or "condition data No." corresponding to the "Da.2 Control method".

- When a method other than "JUMP command" is set for "Da.2 Control method"
 - Set an "M code". If an "M code" is not to be output, set "0" (default value).
- When "JUMP command" is set for "Da.2 Control method"
 - Set the "condition data No.)* for JUMP

- 0 : Unconditionally JUMP to the positioning data set in Da.8.
- 1 to 10 : JUMP according to the condition data No. 1 to No. 10.

* The condition data sets the conditions for executing the JUMP command. (The JUMP is established when the set conditions are satisfied.)

[Table 1]

Pr.11 setting value	Pr.1 setting value	Value set with peripheral device (unit)	Value set with sequence program (unit)
0 : Standard mode	0 : mm	0.01 to 6000000.00 (mm/min)	1 to 600000000 ($\times 10^{-2}$ mm/min)
	1 : inch	0.001 to 600000.000 (inch/min)	1 to 600000000 ($\times 10^{-3}$ inch/min)
	2 : degree	0.001 to 600000.000 (degree/min)	1 to 600000000 ($\times 10^{-3}$ degree/min)
	3 : pulse	1 to 1000000 (pulse/s)	1 to 1000000 (pulse/s)
1 : Stepping motor mode	0 : mm	0.01 to 375000.00 (mm/min)	1 to 37500000 ($\times 10^{-2}$ mm/min)
	1 : inch	0.001 to 37500.000 (inch/min)	1 to 37500000 ($\times 10^{-3}$ inch/min)
	2 : degree	0.001 to 37500.000 (degree/min)	1 to 37500000 ($\times 10^{-3}$ degree/min)
	3 : pulse	1 to 62500 (pulse/s)	1 to 62500 (pulse/s)

[Table 2]

Da.2 setting value	Setting item	Value set with peripheral device	Value set with sequence program
JUMP command : 20 _H	Positioning data No.	1 to 600	1 to 600
Other than JUMP command* : 01 _H to 10 _H	Dwell time	0 to 65535 (ms)	0 to 65535 (ms)

[Table 3]

Da.2 setting value	Setting item	Value set with peripheral device	Value set with sequence program
JUMP command : 20 _H	Condition data No.	0 to 10	0 to 10
Other than JUMP command* : 01 _H to 10 _H	M code	0 to 32767	0 to 32767

* Setting is not required at the actual value modification (11_H).

Da.8 Dwell time/JUMP designation positioning data No.

Set the "dwell time" or "positioning data No." corresponding to the "**Da.2** Control method".

- When a method other than "JUMP command" is set for "**Da.2** Control method" Set the "dwell time".
- When "JUMP command" is set for "**Da.2** Control method" Set the "positioning data No." for the JUMP destination.

When the "dwell time" is set, the setting details of the "dwell time" will be as follows according to "**Da.1** Operation pattern".

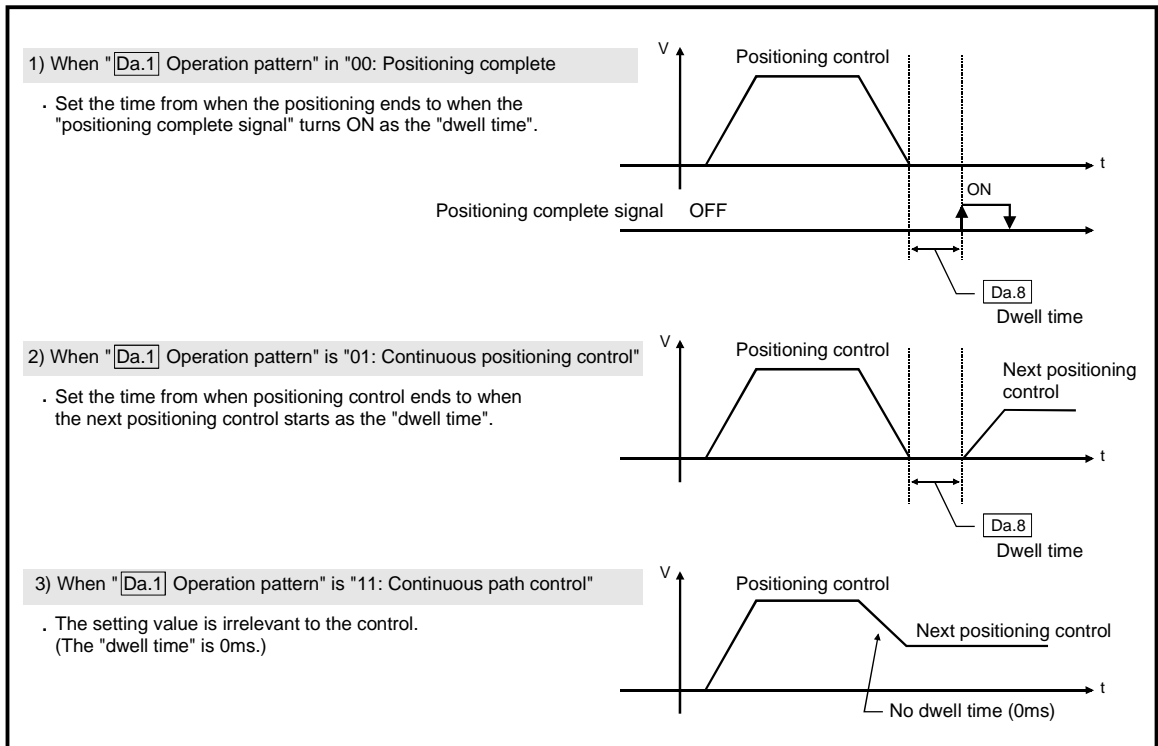

5.4 List of start block data

Before explaining the start block data setting items [Da.1] to [Da.13], the configuration of the start block data will be shown below.

The start block data stored in the AD75 buffer memory has the following type of configuration.

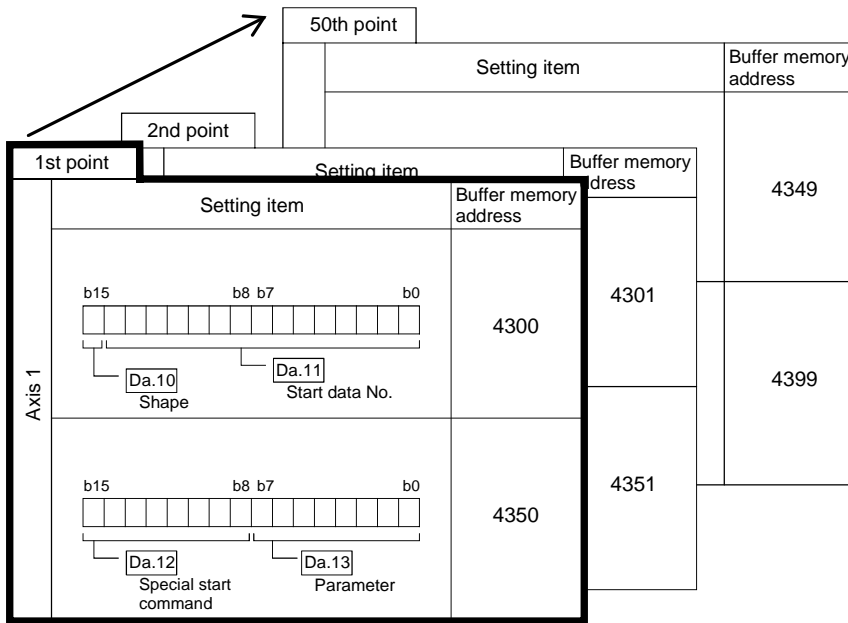

- Up to 50 start block data points can be set (stored) for each axis in the buffer memory address shown on the left.
- One start block data item is configured of the items shown in the bold box.

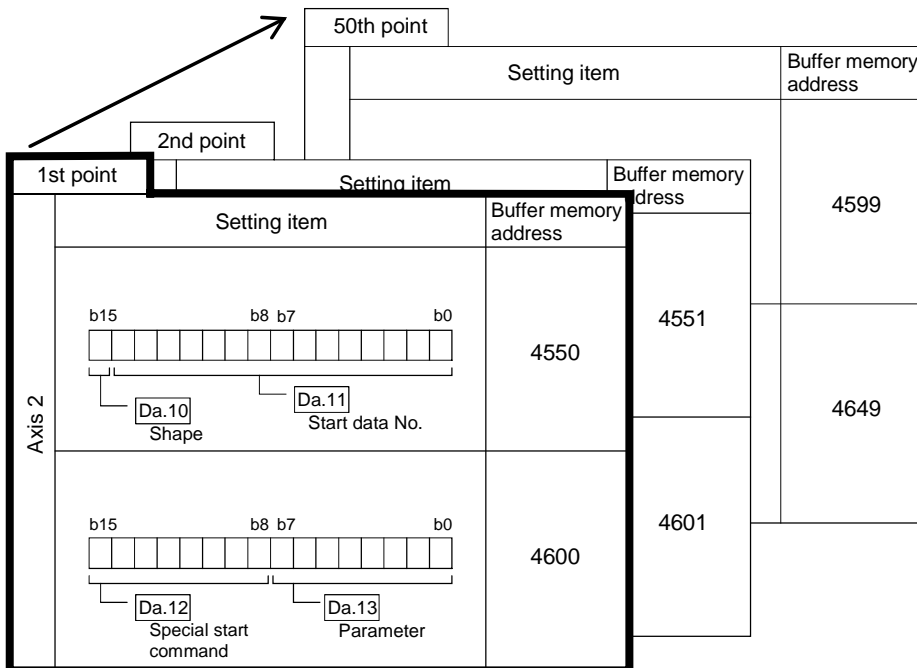

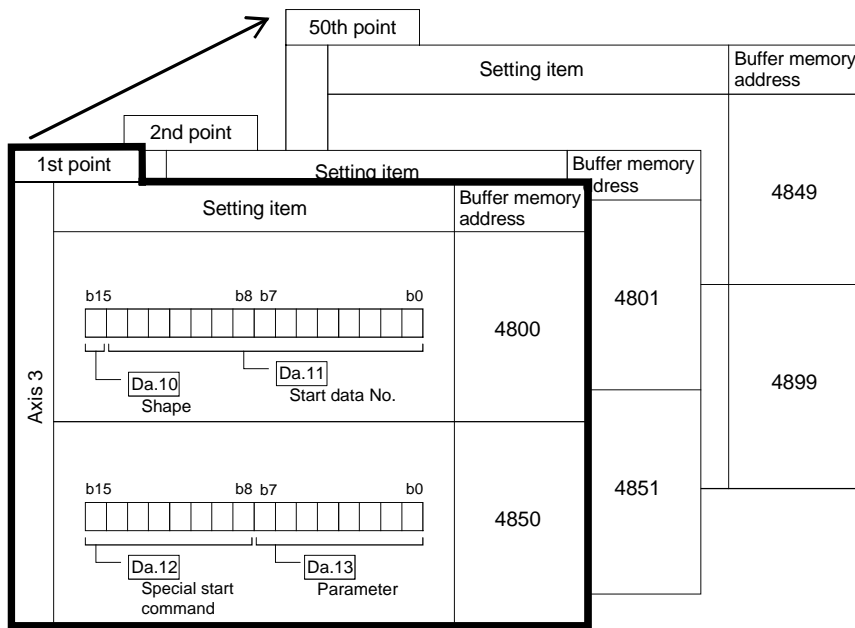

The start block data setting items (Da.10 to Da.13) are explained in the following section.

(The buffer memory addresses for the axis 1 to axis 3 "1st point start block data (block No. 7000)" are shown.)

REMARK

When carrying out advanced positioning control using the "positioning start information", set a number between "7000 and 7010" in "Cd.11 Positioning start No.", and set the "start block data" for the nth point block between "1 and 50" in the "Cd.31 Positioning starting point No."

This number between "7000 and 7010" is called the "block No."

With the AD75, the "start block data (50 points)" and "condition data (10 items)" can be set for each "block No."

* Data corresponding to block No. 7001 to 7010 cannot be set in the buffer memory. The data corresponding to block No. 7001 to 7010 is directly set into the AD75 OS memory from a peripheral device using the AD75 software package.

Block No.	Axis	Start block data	Condition	Buffer memory	AD75 software package
7000	Axis 1	Start block data (1 to 50)	Condition data (1 to 10)	○	○
	Axis 2	Start block data (1 to 50)	Condition data (1 to 10)		
	Axis 3	Start block data (1 to 50)	Condition data (1 to 10)		
7001 to 7010	Axis 1	Start block data (1 to 50)	Condition data (1 to 10)	×	○
	Axis 2	Start block data (1 to 50)	Condition data (1 to 10)		
	Axis 3	Start block data (1 to 50)	Condition data (1 to 10)		

○ : Can be set, × : Cannot be set

Item	Setting value		Default value	Setting value buffer memory address		
	Value set with peripheral device	Value set with sequence program		Axis 1	Axis 2	Axis 3
Da.10 Shape	0 : End	0	0000H	4300	4550	4800
	1 : Continue	1				
Da.11 Start data No.	Positioning data No.: 1 to 600 (01H to 258H)	01H to 258H				
Da.12 Special start command	0 : Normal start	00H	0000H	4350	4600	4850
	1 : Condition start	01H				
	2 : Wait start	02H				
	3 : Simultaneous start	03H				
	4 : Stop	04H				
	5 : FOR loop	05H				
	6 : FOR condition	06H				
	7 : NEXT start	07H				
Da.13 Parameter	Condition data No.: 1 to 10 (01H to 0AH) No. of repetitions: 0 to 255 (00H to FFH)	00H to FFH				

Da.10 Shape

Set whether to carry out only the local "start block data" and then end control, or to execute the "start block data" set in the next point.

Setting value	Setting details
0 : End	Execute the designated point's "start block data", and then complete the control.
1 : Continue	Execute the designated point's "start block data", and after completing control, execute the next point's "start block data".

Da.11 Start data No.

Set the "positioning data No." designated with the "start block data".

Da.12 Special start command

Set the "special start command" for using "advanced positioning control". (Set how to start the positioning data set in [Da.11](#).)

Setting value	Setting details
00H : Block start (Normal start)	Execute the random block positioning data in the set order with one start.
01H : Condition start	Carry out the condition judgment set in "condition data" for the designated positioning data, and when the conditions are established, execute the "start block data". If not established, ignore that "start block data", and then execute the next point's "start block data".
02H : Wait start	Carry out the condition judgment set in "condition data" for the designated positioning data, and when the conditions are established, execute the "start block data". If not established, stop the control (wait) until the conditions are established.
03H : Simultaneous start	Simultaneous execute (output pulses at same timing) the positioning data with the No. designated for the axis designated in the "condition data".
04H : Stop	Stop the positioning operation.
05H : Repeated start (FOR loop)	Repeat the program from the start block data with the "FOR loop" to the start block data with "NEXT" for the designated No. of times.
06H: Repeated start (FOR condition)	Repeat the program from the start block data with the "FOR condition" to the start block data with "NEXT" until the conditions set in the "condition data" are established.
07H : NEXT start	Set the end of the repetition when "05H: Repetition start (FOR loop)" or "06H: Repetition start (FOR condition)" is set.

Refer to "Chapter 10 ADVANCED POSITIONING CONTROL" for details on the control.

Da.13 Parameter

Set the value as required for "Da.12 Special start command".

Da.12 Special start command	Setting value	Setting details
Block start (Normal start)	–	Not used. (There is no need to set.)
Condition start	1 to 10	Set the condition data No. (No. of "condition data" set to perform condition judgment) (For details of the condition data, refer to Section 5.5.)
Wait start		
Simultaneous start		
Stop	–	Not used. (There is no need to set.)
Repeated start (FOR loop)	0 to 255	Set the No. of repetitions.
Repeated start (FOR condition)	1 to 10	Set the condition data No. (No. of "condition data" set to perform condition judgment) (For details of the condition data, refer to Section 5.5.)

5.5 List of condition data

Before explaining the condition data setting items [Da.14] to [Da.18], the configuration of the condition data will be shown below.

The condition data stored in the AD75 buffer memory has the following type of configuration.

		No.10	Setting item		Buffer memory address																								
		No.2			4490																								
		No.1																											
Axis 1	Setting item		Buffer memory address		4410																								
	<table border="1"> <tr> <td>b15</td><td>b12</td><td>b11</td><td>b8</td><td>b7</td><td>b0</td> </tr> <tr> <td> </td><td> </td><td> </td><td> </td><td> </td><td> </td> </tr> <tr> <td colspan="3">[Da.15]</td> <td colspan="3">[Da.14]</td> </tr> <tr> <td colspan="3">Condition operator</td> <td colspan="3">Condition target</td> </tr> </table>		b15	b12		b11	b8	b7	b0							[Da.15]			[Da.14]			Condition operator			Condition target			4400	
	b15	b12	b11	b8	b7	b0																							
	[Da.15]			[Da.14]																									
	Condition operator			Condition target																									
	Open		4401		4412	4491																							
	[Da.16] Address		4402		4413	4492																							
	[Da.17] Parameter 1		4403		4414	4493																							
	[Da.18] Parameter 2		4404		4415	4494																							
Open		4405		4416	4495																								
Open		4406		4417	4496																								
Open		4407		4418	4497																								
Open		4408		4419	4498																								
Open		4409			4499																								

- Up to 10 condition data items can be set (stored) for each axis in the buffer memory address shown on the left.
- One condition data item is configured of the items shown in the bold box.

		No.10	Setting item		Buffer memory address																								
		No.2			4740																								
		No.1																											
Axis 2	Setting item		Buffer memory address		4660																								
	<table border="1"> <tr> <td>b15</td><td>b12</td><td>b11</td><td>b8</td><td>b7</td><td>b0</td> </tr> <tr> <td> </td><td> </td><td> </td><td> </td><td> </td><td> </td> </tr> <tr> <td colspan="3">[Da.15]</td> <td colspan="3">[Da.14]</td> </tr> <tr> <td colspan="3">Condition operator</td> <td colspan="3">Condition target</td> </tr> </table>		b15	b12		b11	b8	b7	b0							[Da.15]			[Da.14]			Condition operator			Condition target			4650	
	b15	b12	b11	b8	b7	b0																							
	[Da.15]			[Da.14]																									
	Condition operator			Condition target																									
	Open		4651		4662	4741																							
	[Da.16] Address		4652		4663	4742																							
	[Da.17] Parameter 1		4653		4664	4743																							
	[Da.18] Parameter 2		4654		4665	4744																							
Open		4655		4666	4745																								
Open		4656		4667	4746																								
Open		4657		4668	4747																								
Open		4658		4669	4748																								
Open		4659			4749																								

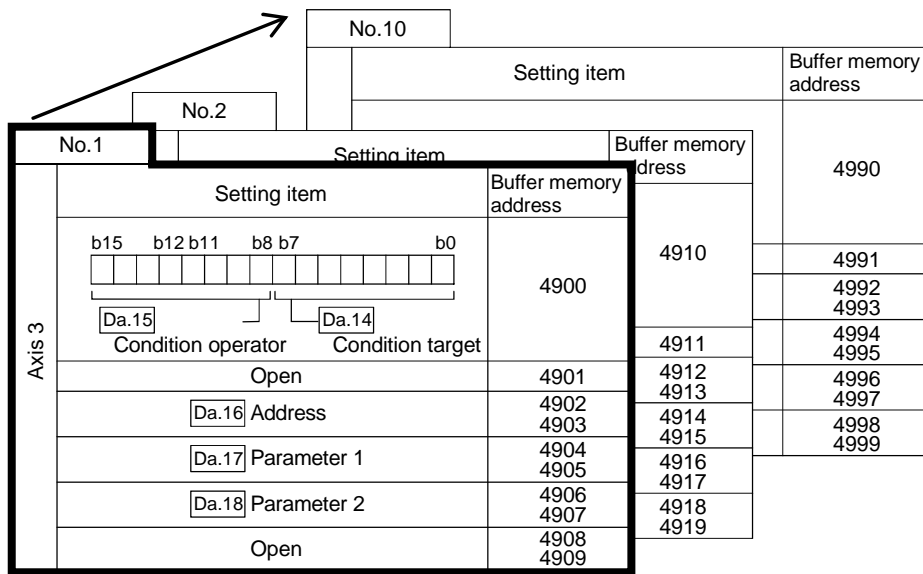

The condition data setting items (Da.14 to Da.18) are explained in the following section.

(The buffer memory addresses for the axis 1 to axis 3 "condition data No. 1 (block No. 7000)" are shown.)

REMARK

When carrying out advanced positioning control using the "positioning start information", set a number between "7000 and 7010" in "Cd.11 Positioning start No.", and set the "start block data" for the nth point block between "1 and 50" in the "Cd.31 Positioning starting point No."

This number between "7000 and 7010" is called the "block No."

With the AD75, the "start block data (50 points)" and "condition data (10 items)" can be set for each "block No."

* Data corresponding to block No. 7001 to 7010 cannot be set in the buffer memory. The data corresponding to block No. 7001 to 7010 is directly set into the AD75 OS memory from a peripheral device using the AD75 software package.

Block No.	Axis	Start block data	Condition	Buffer memory	AD75 software package
7000	Axis 1	Start block data (1 to 50)	Condition data (1 to 10)	○	○
	Axis 2	Start block data (1 to 50)	Condition data (1 to 10)		
	Axis 3	Start block data (1 to 50)	Condition data (1 to 10)		
7001 to 7010	Axis 1	Start block data (1 to 50)	Condition data (1 to 10)	×	○
	Axis 2	Start block data (1 to 50)	Condition data (1 to 10)		
	Axis 3	Start block data (1 to 50)	Condition data (1 to 10)		

○ : Can be set, × : Cannot be set

Item	Setting value		Default value	Setting value buffer memory address			
	Value set with peripheral device	Value set with sequence program		Axis 1	Axis 2	Axis 3	
Condition identifier	Da.14 Condition target	01 : Device X	01H	0000H	4490	4740	4990
		02 : Device Y	02H				
		03 : Buffer memory (1-word)	03H				
		04 : Buffer memory (2-word)	04H				
		05 : Positioning data No.	05H				
	Da.15 Condition operator	01 : **=P1	01H				
		02 : **≠P1	02H				
		03 : **≤P1	03H				
		04 : **>P1	04H				
		05 : P1≤**≤P2	05H				
		06 : **≤P1, P2≤**	06H				
		07 : DEV=ON	07H				
		08 : DEV=OFF	08H				
		09 : Axis 1 designation	09H				
0A : Axis 2 designation	0AH						
0B : Axis 1 and axis 2 designation	0BH						
0C : Axis 3 designation	0CH						
0D : Axis 1 and axis 3 designation	0DH						
0E : Axis 2 and axis 3 designation	0EH						

Da.16	Address	Buffer memory address	Example) <div style="text-align: center;"> </div>	0000H	4492 4493	4742 4743	4992 4993
Da.17	Parameter 1	Value	Example) <div style="text-align: center;"> </div>	0000H	4494 4495	4744 4745	4994 4995
Da.18	Parameter 2	Value	Example) <div style="text-align: center;"> </div>	0000H	4496 4497	4746 4747	4996 4997

Da.14 Condition target

Set the condition target as required for each control.

Setting value	Setting details
01H : Device X 02H : Device Y	Set the input/output signal ON/OFF as the conditions.
03H : Buffer memory (1-word) 04H : Buffer memory (2-word)	Set the value stored in the buffer memory as the condition. 03H: The target buffer memory is "1-word (16 bits)" 04H: The target buffer memory is "2-word (32 bits)"
05H : Positioning data No.	Select only for "simultaneous start".

Da.15 Condition operator

Set the condition operator as required for the "**Da.14** Condition target".

Da.14 Condition target	Setting value	Setting details
01H : Device X 02H : Device Y	07H : DEV=ON 08H : DEV=OFF	When the input/output signal ON/OFF is set as the condition, set "ON" or "OFF".
03H : Buffer memory (1-word) 04H : Buffer memory (2-word)	01H : **=P1 ↓ 06H : **≤P1, P2≤**	Set how to judge the conditions for the value (**) target stored in the buffer memory.
05H : Positioning data No.	09H : Axis 1 designation ↓ 0EH : Axis 2 and axis 3 designation	Set the axis to start simultaneously when "simultaneous start" is selected.

Da.16 Address

Set the address as required for the "**Da.14** Condition target".

Da.14 Condition target	Setting value	Setting details
01H : Device X 02H : Device Y	–	Not used. (There is no need to set.)
03H : Buffer memory (1-word) 04H : Buffer memory (2-word)	Value (Buffer memory address)	Set the target "buffer memory address". (For 2 word, set the low-order buffer memory address.)
05H : Positioning data No.	–	Not used. (There is no need to set.)

Da.17 Parameter 1Set the parameters as required for the "**Da.15** Condition operator".

Da.15 Condition operator	Setting value	Setting details
01H : **=P1	Value	Set the "P1" value.
↓		
06H : **≤P1, P2≤**	Value (Bit No.)	Set the device's bit No. X : 0H to FH, Y : 10H to 1DH
07H : DEV=ON 08H : DEV=OFF		
09H : Axis 1 designation	Value (Positioning data No.)	Set the positioning data No. for starting axis 1 and axis 2. Low-order 16-bit: Axis 1 positioning data No. 1 to 600 (01H to 258H) High-order 16-bit: Axis 2 positioning data No. 1 to 600 (01H to 258H)
↓		
0EH : Axis 2 and axis 3 designation		

Da.18 Parameter 2Set the parameters as required for the "**Da.15** Condition operator".

Da.15 Condition operator	Setting value	Setting details
01H : **=P1	-	Not used. (There is no need to set.)
↓		
04H : **≥P1		
05H : P1≤**≤ P2	Value	Set the "P2" value.
06H : **≤P1, P2≤**	-	Not used. (There is no need to set.)
07H : DEV=ON		
08H : DEV=OFF		
09H : Axis 1 designation		
0AH : Axis 2 designation		
0BH : Axis 1 and axis 2 designation		
0CH : Axis 3 designation	Value (Positioning data No.)	Set the positioning data No. for starting axis 3. Low-order 16-bit: Axis 3 positioning data No. 1 to 600 (01H to 258H) High-order 16-bit: No setting
0DH : Axis 1 and axis 3 designation		
0EH : Axis 2 and axis 3 designation		



5.6 List of monitor data

5.6.1 System monitor data

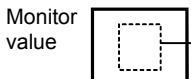
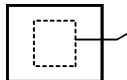
Storage item	Storage details
Md.1 In test mode flag	Whether the mode is the test mode from the peripheral device or not is stored. <ul style="list-style-type: none"> • When not in test mode : OFF • When in test mode : ON
Md.2 Module name	The AD75 module name is stored.
Md.3 OS type	The AD75 OS type is stored. (Stored with an 8-character ASCII code.)
Md.4 OS version	The AD75 OS version is stored. (Stored with a 4-character ASCII code.)
Md.5 Clock data (hour: minute)	The software clock data created by the system in the AD75 is stored. <ul style="list-style-type: none"> • This is used to record the history occurrence time. Note) To utilize the clock data, the correct time must be set from the PLC CPU with Cd.1 to Cd.3. If this setting is not made, the clock data will start counting from "00 hours 00 minutes" when the AD75 power is turned ON.
Md.6 Clock data (second: 100 ms)	The software clock data created by the system in the AD75 is stored. <ul style="list-style-type: none"> • This is used to record the history occurrence time. Note) To utilize the clock data, the correct time must be set from the PLC CPU with Cd.1 to Cd.3. If this setting is not made, the clock data will start counting from "00 seconds 00 ms" when the AD75 power is turned ON.

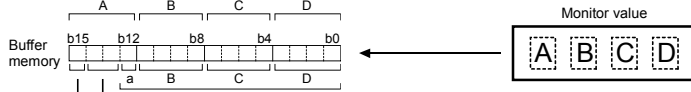
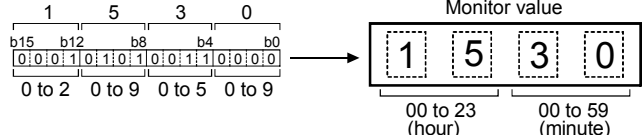
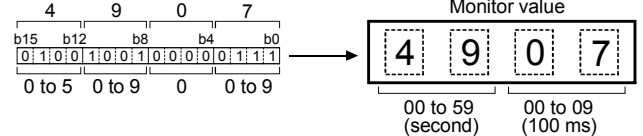

Reading the monitor value	Default value	Storage buffer memory address (common for axis 1 to axis 3)																																												
<p>■ Monitoring is carried out with a decimal.</p> <p>Monitor value </p> <p>● Storage value 0: Not in test mode 1: In test mode</p>	0	450																																												
<p>■ Monitoring is carried out with a decimal.</p> <p>Monitor value </p> <p>● Storage value 0: A1SD75P1-S3/AD75P1-S3 1: A1SD75P2-S3/AD75P2-S3 2: A1SD75P3-S3/AD75P3-S3</p>	- (Corresponding name)	451																																												
<p>■ Monitoring is carried out with a hexadecimal.</p> <p>Example) When name is "AD75" and OS type is "S003".</p> <p>Monitor value</p> <table border="1" data-bbox="582 772 805 1108"> <tr> <td>452</td> <td>3</td> <td>7</td> <td>3</td> <td>5</td> <td rowspan="2">Name → AD75</td> </tr> <tr> <td></td> <td>7</td> <td></td> <td>5</td> <td></td> </tr> <tr> <td>453</td> <td>4</td> <td>1</td> <td>4</td> <td>4</td> <td rowspan="2">A D</td> </tr> <tr> <td></td> <td></td> <td></td> <td></td> <td></td> </tr> <tr> <td>454</td> <td>3</td> <td>0</td> <td>3</td> <td>3</td> <td rowspan="2">OS type → S003</td> </tr> <tr> <td></td> <td>0</td> <td></td> <td>3</td> <td></td> </tr> <tr> <td>455</td> <td>5</td> <td>3</td> <td>3</td> <td>0</td> <td rowspan="2">S 0</td> </tr> <tr> <td></td> <td></td> <td></td> <td></td> <td></td> </tr> </table> <p>(Converted with ASCII code)</p>	452	3	7	3	5	Name → AD75		7		5		453	4	1	4	4	A D						454	3	0	3	3	OS type → S003		0		3		455	5	3	3	0	S 0						- (Corresponding OS name)	452 453 454 455
452	3	7	3	5	Name → AD75																																									
	7		5																																											
453	4	1	4	4	A D																																									
454	3	0	3	3	OS type → S003																																									
	0		3																																											
455	5	3	3	0	S 0																																									
<p>■ Monitoring is carried out with a hexadecimal.</p> <p>Example) When OS version is "V00M".</p> <p>Monitor value</p> <table border="1" data-bbox="454 1265 646 1444"> <tr> <td>456</td> <td>3</td> <td>0</td> <td>4</td> <td>D</td> <td rowspan="2">OS version → V00M</td> </tr> <tr> <td></td> <td>0</td> <td></td> <td>M</td> <td></td> </tr> <tr> <td>457</td> <td>5</td> <td>6</td> <td>3</td> <td>0</td> <td rowspan="2">V 0</td> </tr> <tr> <td></td> <td></td> <td></td> <td></td> <td></td> </tr> </table> <p>(Converted with ASCII code)</p>	456	3	0	4	D	OS version → V00M		0		M		457	5	6	3	0	V 0						- (Corresponding OS version)	456 457																						
456	3	0	4	D	OS version → V00M																																									
	0		M																																											
457	5	6	3	0	V 0																																									
<p>■ Monitoring is carried out with a hexadecimal.</p> <p>Buffer memory (stored with BCD code)</p> <table border="1" data-bbox="247 1579 550 1691"> <tr> <td>1</td> <td>5</td> <td>3</td> <td>0</td> </tr> <tr> <td>b15</td> <td>b12</td> <td>b8</td> <td>b4</td> <td>b0</td> </tr> <tr> <td>0:0:0:1</td> <td>0:1:0:1</td> <td>1:0:0:1</td> <td>1:0:0:1</td> <td>0:0:0:0</td> </tr> <tr> <td>0 to 2</td> <td>0 to 9</td> <td>0 to 5</td> <td>0 to 9</td> <td></td> </tr> </table> <p>Monitor value</p> <table border="1" data-bbox="646 1601 933 1724"> <tr> <td>1</td> <td>5</td> <td>3</td> <td>0</td> </tr> <tr> <td colspan="2">00 to 23 (hour)</td> <td colspan="2">00 to 59 (minute)</td> </tr> </table>	1	5	3	0	b15	b12	b8	b4	b0	0:0:0:1	0:1:0:1	1:0:0:1	1:0:0:1	0:0:0:0	0 to 2	0 to 9	0 to 5	0 to 9		1	5	3	0	00 to 23 (hour)		00 to 59 (minute)		0000	460																	
1	5	3	0																																											
b15	b12	b8	b4	b0																																										
0:0:0:1	0:1:0:1	1:0:0:1	1:0:0:1	0:0:0:0																																										
0 to 2	0 to 9	0 to 5	0 to 9																																											
1	5	3	0																																											
00 to 23 (hour)		00 to 59 (minute)																																												
<p>■ Monitoring is carried out with a hexadecimal.</p> <p>Buffer memory (stored with BCD code)</p> <table border="1" data-bbox="247 1825 550 1937"> <tr> <td>4</td> <td>9</td> <td>0</td> <td>7</td> </tr> <tr> <td>b15</td> <td>b12</td> <td>b8</td> <td>b4</td> <td>b0</td> </tr> <tr> <td>0:1:0:0</td> <td>1:0:0:1</td> <td>0:0:0:0</td> <td>0:1:1:1</td> </tr> <tr> <td>0 to 5</td> <td>0 to 9</td> <td>0</td> <td>0 to 9</td> </tr> </table> <p>Monitor value</p> <table border="1" data-bbox="646 1848 933 1971"> <tr> <td>4</td> <td>9</td> <td>0</td> <td>7</td> </tr> <tr> <td colspan="2">00 to 59 (second)</td> <td colspan="2">00 to 09 (100 ms)</td> </tr> </table>	4	9	0	7	b15	b12	b8	b4	b0	0:1:0:0	1:0:0:1	0:0:0:0	0:1:1:1	0 to 5	0 to 9	0	0 to 9	4	9	0	7	00 to 59 (second)		00 to 09 (100 ms)		0000	461																			
4	9	0	7																																											
b15	b12	b8	b4	b0																																										
0:1:0:0	1:0:0:1	0:0:0:0	0:1:1:1																																											
0 to 5	0 to 9	0	0 to 9																																											
4	9	0	7																																											
00 to 59 (second)		00 to 09 (100 ms)																																												

(Unless noted in particular, the monitor value is saved as binary data.)

Storage item	Storage details	Reading the monitor value																																																													
Md.7 Start axis	The No. of the axis that started is stored.	<p>Monitoring is carried out with a decimal.</p> <p>Monitor value  ● Storage value 1: Axis 1 2: Axis 2 3: Axis 3</p>																																																													
Md.8 Operation type	<p>[Stored contents] The operation information (restart flag, start origin, operation type) is stored.</p> <ul style="list-style-type: none"> Restart flag : Whether the operation restarted after stopping once Start origin : Where the start signal was input from Operation type : What type of operation was carried out <p>[Reading the monitor value] Monitoring is carried out with a hexadecimal.</p>	 <table border="1"> <thead> <tr> <th rowspan="2">Stored contents</th> <th colspan="4">Storage value</th> <th rowspan="2">Remarks (decimal)</th> </tr> <tr> <th>a</th> <th>B</th> <th>C</th> <th>D</th> </tr> </thead> <tbody> <tr> <td rowspan="3">Positioning operation</td> <td>0</td> <td>0</td> <td>0</td> <td>1</td> <td>001</td> </tr> <tr> <td>0</td> <td>2</td> <td>5</td> <td>8</td> <td>600</td> </tr> <tr> <td>1</td> <td>B</td> <td>5</td> <td>8</td> <td>7000</td> </tr> <tr> <td rowspan="2">Block positioning operation</td> <td>1</td> <td>B</td> <td>6</td> <td>2</td> <td>7010</td> </tr> <tr> <td>1</td> <td>F</td> <td>7</td> <td>C</td> <td>8060</td> </tr> <tr> <td>JOG operation</td> <td>1</td> <td>F</td> <td>7</td> <td>D</td> <td>8061</td> </tr> <tr> <td>Manual pulse generator operation</td> <td>1</td> <td>F</td> <td>7</td> <td>3</td> <td>8051</td> </tr> <tr> <td>Machine zero point return</td> <td>1</td> <td>F</td> <td>7</td> <td>4</td> <td>8052</td> </tr> <tr> <td>Current value change</td> <td>1</td> <td>F</td> <td>7</td> <td>5</td> <td>8053</td> </tr> </tbody> </table> <p>a : Binary, B to D: Hexadecimal</p>	Stored contents	Storage value				Remarks (decimal)	a	B	C	D	Positioning operation	0	0	0	1	001	0	2	5	8	600	1	B	5	8	7000	Block positioning operation	1	B	6	2	7010	1	F	7	C	8060	JOG operation	1	F	7	D	8061	Manual pulse generator operation	1	F	7	3	8051	Machine zero point return	1	F	7	4	8052	Current value change	1	F	7	5	8053
Stored contents	Storage value				Remarks (decimal)																																																										
	a	B	C	D																																																											
Positioning operation	0	0	0	1	001																																																										
	0	2	5	8	600																																																										
	1	B	5	8	7000																																																										
Block positioning operation	1	B	6	2	7010																																																										
	1	F	7	C	8060																																																										
JOG operation	1	F	7	D	8061																																																										
Manual pulse generator operation	1	F	7	3	8051																																																										
Machine zero point return	1	F	7	4	8052																																																										
Current value change	1	F	7	5	8053																																																										
Md.9 Start time (Hour: minute)	The starting time is stored. (Software clock data created by system in AD75.)	<p>Monitoring is carried out with a hexadecimal.</p> <p>Buffer memory (stored with BCD code)</p> 																																																													
Md.10 Start time (Second:100 ms)	The starting time is stored. (Software clock data created by system in AD75.)	<p>Monitoring is carried out with a hexadecimal.</p> <p>Buffer memory (stored with BCD code)</p> 																																																													
Md.11 Error judgment	<p>[Stored contents] The error judgment results when starting (shown below) are stored.</p> <ul style="list-style-type: none"> BUSY start warning flag Error flag Error No. <p>[Reading the monitor value] Monitoring is carried out with a hexadecimal.</p>	 <p>● Error flag</p> <table border="1"> <thead> <tr> <th>Stored contents</th> <th>Storage value</th> </tr> </thead> <tbody> <tr> <td>Error flag OFF</td> <td>0</td> </tr> <tr> <td>Error flag ON</td> <td>1</td> </tr> </tbody> </table> <p>● Error No.</p> <p>a, B, C and D are converted into a decimal, which can be confirmed in section "14.2 List of errors".</p> <p>● BUSY start warning</p> <table border="1"> <thead> <tr> <th>Stored contents</th> <th>Storage value</th> </tr> </thead> <tbody> <tr> <td>BUSY start warning OFF</td> <td>0</td> </tr> <tr> <td>BUSY start warning ON</td> <td>1</td> </tr> </tbody> </table>	Stored contents	Storage value	Error flag OFF	0	Error flag ON	1	Stored contents	Storage value	BUSY start warning OFF	0	BUSY start warning ON	1																																																	
Stored contents	Storage value																																																														
Error flag OFF	0																																																														
Error flag ON	1																																																														
Stored contents	Storage value																																																														
BUSY start warning OFF	0																																																														
BUSY start warning ON	1																																																														
Md.12 Starting history pointer	The pointer No. following the pointer No. where the latest start history is stored is indicated.	<p>Monitoring is carried out with a decimal.</p> <p>Monitor value  ● Storage value (Pointer No.) 0 to 15</p>																																																													



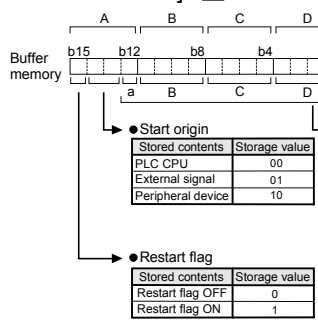
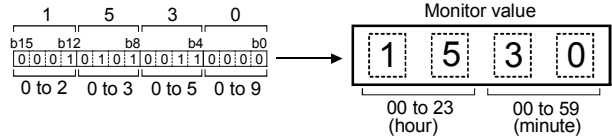
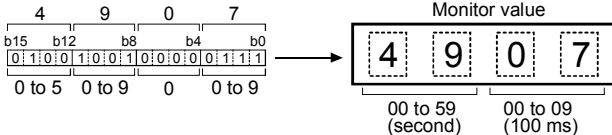
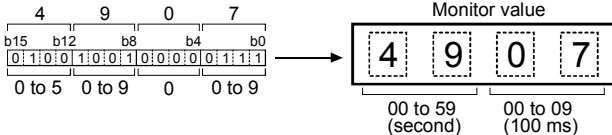
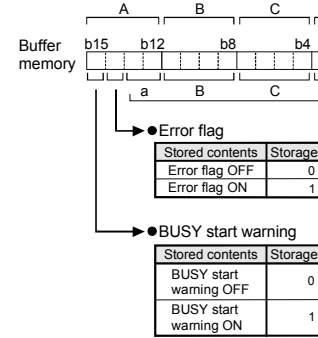

Starting history (up to 16 items can be stored)

Default value	Storage buffer memory address (common for axis 1 to axis 3)																																																																																																							
0																																																																																																								
0000H	<div style="text-align: center;"> <table border="1" style="margin: auto;"> <tr> <td style="padding: 2px;">Md.12</td> <td style="padding: 2px;">Starting history pointer</td> <td style="padding: 2px;">542</td> </tr> </table> <p style="text-align: center;">↑ The pointer No. following the pointer No. where the latest start history is stored is stored.</p> </div>		Md.12	Starting history pointer	542																																																																																																			
Md.12	Starting history pointer	542																																																																																																						
0000	<div style="display: flex; align-items: center;"> <div style="margin-right: 10px;"> <p>Pointer No. ↓</p> </div> <table border="1" style="border-collapse: collapse; text-align: center;"> <tr> <td style="width: 100px; text-align: left;">Starting history</td> <td style="width: 100px;">Pointer No. 0</td> <td style="width: 100px;">1</td> <td style="width: 100px;">2</td> <td style="width: 100px;">3</td> <td style="width: 100px;">4</td> <td style="width: 100px;">5</td> <td style="width: 100px;">6</td> <td style="width: 100px;">7</td> <td style="width: 100px;">8</td> <td style="width: 100px;">9</td> <td style="width: 100px;">10</td> <td style="width: 100px;">11</td> <td style="width: 100px;">12</td> <td style="width: 100px;">13</td> <td style="width: 100px;">14</td> <td style="width: 100px;">15</td> </tr> <tr> <td style="text-align: right;">Md.7 Start axis</td> <td>462</td><td>467</td><td>472</td><td>477</td><td>482</td><td>487</td><td>492</td><td>497</td><td>502</td><td>507</td><td>512</td><td>517</td><td>522</td><td>527</td><td>532</td><td>537</td> </tr> <tr> <td style="text-align: right;">Md.8 Operation type</td> <td>463</td><td>468</td><td>473</td><td>478</td><td>483</td><td>488</td><td>493</td><td>498</td><td>503</td><td>508</td><td>513</td><td>518</td><td>523</td><td>528</td><td>533</td><td>538</td> </tr> <tr> <td style="text-align: right;">Md.9 Start time (Hour: minute)</td> <td>464</td><td>469</td><td>474</td><td>479</td><td>484</td><td>489</td><td>494</td><td>499</td><td>504</td><td>509</td><td>514</td><td>519</td><td>524</td><td>529</td><td>534</td><td>539</td> </tr> <tr> <td style="text-align: right;">Md.10 Start time (Second: 100ms)</td> <td>465</td><td>470</td><td>475</td><td>480</td><td>485</td><td>490</td><td>495</td><td>500</td><td>505</td><td>510</td><td>515</td><td>520</td><td>525</td><td>530</td><td>535</td><td>540</td> </tr> <tr> <td style="text-align: right;">Md.11 Error judgment</td> <td>466</td><td>471</td><td>476</td><td>481</td><td>486</td><td>491</td><td>496</td><td>501</td><td>506</td><td>511</td><td>516</td><td>521</td><td>526</td><td>531</td><td>536</td><td>541</td> </tr> </table> </div>		Starting history	Pointer No. 0	1	2	3	4	5	6	7	8	9	10	11	12	13	14	15	Md.7 Start axis	462	467	472	477	482	487	492	497	502	507	512	517	522	527	532	537	Md.8 Operation type	463	468	473	478	483	488	493	498	503	508	513	518	523	528	533	538	Md.9 Start time (Hour: minute)	464	469	474	479	484	489	494	499	504	509	514	519	524	529	534	539	Md.10 Start time (Second: 100ms)	465	470	475	480	485	490	495	500	505	510	515	520	525	530	535	540	Md.11 Error judgment	466	471	476	481	486	491	496	501	506	511	516	521	526	531	536	541
Starting history	Pointer No. 0	1	2	3	4	5	6	7	8	9	10	11	12	13	14	15																																																																																								
Md.7 Start axis	462	467	472	477	482	487	492	497	502	507	512	517	522	527	532	537																																																																																								
Md.8 Operation type	463	468	473	478	483	488	493	498	503	508	513	518	523	528	533	538																																																																																								
Md.9 Start time (Hour: minute)	464	469	474	479	484	489	494	499	504	509	514	519	524	529	534	539																																																																																								
Md.10 Start time (Second: 100ms)	465	470	475	480	485	490	495	500	505	510	515	520	525	530	535	540																																																																																								
Md.11 Error judgment	466	471	476	481	486	491	496	501	506	511	516	521	526	531	536	541																																																																																								
0000	<div style="display: flex; justify-content: center; gap: 20px;"> <div style="text-align: center;"> <p>↑ Item</p> </div> <div style="text-align: center;"> <p>↑ Buffer memory address</p> </div> </div> <ul style="list-style-type: none"> A "pointer No." is assigned to each block of buffer memory that configures one start history. <p>Example)</p> <ul style="list-style-type: none"> Pointer No. 0 = Buffer memory 462 to 466 Pointer No. 1 = Buffer memory 467 to 471 Pointer No. 2 = Buffer memory 472 to 476 																																																																																																							
0000H	<ul style="list-style-type: none"> The history is stored in order in pointer No. "0" to "15". If the No. of history items exceeds this, the history will return to "0" and be stored in order. (When newly storing history items, the previous history will be cleared.) 																																																																																																							
0	542																																																																																																							

Storage item	Storage details	Reading the monitor value																																																																												
Md.13 Start axis	The No. of the axis for which an error was detected when starting is stored.	<p>■ Monitoring is carried out with a decimal.</p> <p>Monitor value </p> <p>● Storage value 1: Axis 1 2: Axis 2 3: Axis 3</p>																																																																												
Md.14 Operation type	<p>[Stored contents] The operation information (restart flag, start origin, operation type) is stored.</p> <ul style="list-style-type: none"> Restart flag : Whether the operation restarted after stopping once Start origin : Where the start signal was input from Operation type : What type of operation was carried out <p>[Reading the monitor value] ■ Monitoring is carried out with a hexadecimal.</p>  <table border="1" data-bbox="646 750 837 817"> <thead> <tr> <th>Stored contents</th> <th>Storage value</th> </tr> </thead> <tbody> <tr> <td>PLC CPU</td> <td>00</td> </tr> <tr> <td>External signal</td> <td>01</td> </tr> <tr> <td>Peripheral device</td> <td>10</td> </tr> </tbody> </table> <table border="1" data-bbox="646 873 837 929"> <thead> <tr> <th>Stored contents</th> <th>Storage value</th> </tr> </thead> <tbody> <tr> <td>Restart flag OFF</td> <td>0</td> </tr> <tr> <td>Restart flag ON</td> <td>1</td> </tr> </tbody> </table> <table border="1" data-bbox="869 750 1316 974"> <thead> <tr> <th rowspan="2">Stored contents</th> <th colspan="4">Storage value</th> <th rowspan="2">Remarks (decimal)</th> </tr> <tr> <th>a</th> <th>B</th> <th>C</th> <th>D</th> </tr> </thead> <tbody> <tr> <td rowspan="2">Positioning operation</td> <td>0</td> <td>0</td> <td>0</td> <td>1</td> <td>001</td> </tr> <tr> <td>0</td> <td>2</td> <td>5</td> <td>8</td> <td>600</td> </tr> <tr> <td rowspan="2">Block positioning operation</td> <td>1</td> <td>B</td> <td>5</td> <td>8</td> <td>7000</td> </tr> <tr> <td>1</td> <td>B</td> <td>6</td> <td>2</td> <td>7010</td> </tr> <tr> <td>JOG operation</td> <td>1</td> <td>F</td> <td>7</td> <td>C</td> <td>8060</td> </tr> <tr> <td>Manual pulse generator operation</td> <td>1</td> <td>F</td> <td>7</td> <td>D</td> <td>8061</td> </tr> <tr> <td>Machine zero point return</td> <td>1</td> <td>F</td> <td>7</td> <td>3</td> <td>8051</td> </tr> <tr> <td>High-speed zero point return</td> <td>1</td> <td>F</td> <td>7</td> <td>4</td> <td>8052</td> </tr> <tr> <td>Current value change</td> <td>1</td> <td>F</td> <td>7</td> <td>5</td> <td>8053</td> </tr> </tbody> </table> <p>a : Binary, B to D: Hexadecimal</p>	Stored contents	Storage value	PLC CPU	00	External signal	01	Peripheral device	10	Stored contents	Storage value	Restart flag OFF	0	Restart flag ON	1	Stored contents	Storage value				Remarks (decimal)	a	B	C	D	Positioning operation	0	0	0	1	001	0	2	5	8	600	Block positioning operation	1	B	5	8	7000	1	B	6	2	7010	JOG operation	1	F	7	C	8060	Manual pulse generator operation	1	F	7	D	8061	Machine zero point return	1	F	7	3	8051	High-speed zero point return	1	F	7	4	8052	Current value change	1	F	7	5	8053	<p>■ Monitoring is carried out with a hexadecimal.</p> <p>Buffer memory (stored with BCD code)</p>  <p>Monitor value</p> <p>1 5 3 0</p> <p>00 to 23 (hour) 00 to 59 (minute)</p>
Stored contents	Storage value																																																																													
PLC CPU	00																																																																													
External signal	01																																																																													
Peripheral device	10																																																																													
Stored contents	Storage value																																																																													
Restart flag OFF	0																																																																													
Restart flag ON	1																																																																													
Stored contents	Storage value				Remarks (decimal)																																																																									
	a	B	C	D																																																																										
Positioning operation	0	0	0	1	001																																																																									
	0	2	5	8	600																																																																									
Block positioning operation	1	B	5	8	7000																																																																									
	1	B	6	2	7010																																																																									
JOG operation	1	F	7	C	8060																																																																									
Manual pulse generator operation	1	F	7	D	8061																																																																									
Machine zero point return	1	F	7	3	8051																																																																									
High-speed zero point return	1	F	7	4	8052																																																																									
Current value change	1	F	7	5	8053																																																																									
Md.15 Start time (Hour: minute)	The error detection time is stored. (Software clock data created by system in AD75.)	<p>■ Monitoring is carried out with a hexadecimal.</p> <p>Buffer memory (stored with BCD code)</p>  <p>Monitor value</p> <p>4 9 0 7</p> <p>00 to 59 (second) 00 to 09 (100 ms)</p>																																																																												
Md.16 Start time (Second:100 ms)	The error detection time is stored. (Software clock data created by system in AD75.)	<p>■ Monitoring is carried out with a hexadecimal.</p> <p>Buffer memory (stored with BCD code)</p>  <p>Monitor value</p> <p>4 9 0 7</p> <p>00 to 59 (second) 00 to 09 (100 ms)</p>																																																																												
Md.17 Error judgment	<p>[Stored contents] The error judgment results when starting (shown below) are stored.</p> <ul style="list-style-type: none"> BUSY start warning flag Error flag Error No. <p>[Reading the monitor value] ■ Monitoring is carried out with a hexadecimal.</p>  <table border="1" data-bbox="678 1691 885 1758"> <thead> <tr> <th>Stored contents</th> <th>Storage value</th> </tr> </thead> <tbody> <tr> <td>Error flag OFF</td> <td>0</td> </tr> <tr> <td>Error flag ON</td> <td>1</td> </tr> </tbody> </table> <table border="1" data-bbox="678 1792 885 1892"> <thead> <tr> <th>Stored contents</th> <th>Storage value</th> </tr> </thead> <tbody> <tr> <td>BUSY start warning OFF</td> <td>0</td> </tr> <tr> <td>BUSY start warning ON</td> <td>1</td> </tr> </tbody> </table> <p>a, B, C and D are converted into a decimal, which can be confirmed in section "14.2 List of errors".</p>	Stored contents	Storage value	Error flag OFF	0	Error flag ON	1	Stored contents	Storage value	BUSY start warning OFF	0	BUSY start warning ON	1	<p>■ Monitoring is carried out with a decimal.</p> <p>Monitor value </p> <p>● Storage value (Pointer No.) 0 to 15</p>																																																																
Stored contents	Storage value																																																																													
Error flag OFF	0																																																																													
Error flag ON	1																																																																													
Stored contents	Storage value																																																																													
BUSY start warning OFF	0																																																																													
BUSY start warning ON	1																																																																													
Md.18 Starting history pointer at error	The pointer No. following the pointer No. where the latest start history during errors is stored is indicated.	<p>■ Monitoring is carried out with a decimal.</p> <p>Monitor value </p> <p>● Storage value (Pointer No.) 0 to 15</p>																																																																												



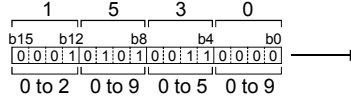

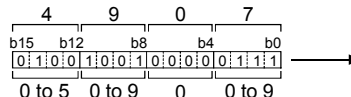
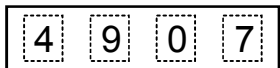
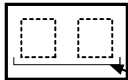
Error at start history (up to 16 items can be stored)

Default value	Storage buffer memory address (common for axis 1 to axis 3)																																																																																																							
0																																																																																																								
0000H	<div style="text-align: center;"> <table border="1" style="margin: auto;"> <tr> <td style="padding: 2px;">Md.18</td> <td style="padding: 2px;">Starting history pointer at error</td> <td style="padding: 2px;">623</td> </tr> </table> <p style="text-align: center;">▲ The pointer No. following the pointer No. where the latest start history during errors is stored is stored.</p> </div>		Md.18	Starting history pointer at error	623																																																																																																			
Md.18	Starting history pointer at error	623																																																																																																						
0000	<div style="display: flex; align-items: center;"> <div style="margin-right: 10px;"> <p>Pointer No. ↓</p> </div> <table border="1" style="border-collapse: collapse; text-align: center;"> <tr> <td style="width: 20px; height: 20px;"></td> <td style="width: 20px; height: 20px;">0</td> <td style="width: 20px; height: 20px;">1</td> <td style="width: 20px; height: 20px;">2</td> <td style="width: 20px; height: 20px;">3</td> <td style="width: 20px; height: 20px;">4</td> <td style="width: 20px; height: 20px;">5</td> <td style="width: 20px; height: 20px;">6</td> <td style="width: 20px; height: 20px;">7</td> <td style="width: 20px; height: 20px;">8</td> <td style="width: 20px; height: 20px;">9</td> <td style="width: 20px; height: 20px;">10</td> <td style="width: 20px; height: 20px;">11</td> <td style="width: 20px; height: 20px;">12</td> <td style="width: 20px; height: 20px;">13</td> <td style="width: 20px; height: 20px;">14</td> <td style="width: 20px; height: 20px;">15</td> </tr> </table> </div> <table border="1" style="border-collapse: collapse; text-align: center;"> <tr> <td style="width: 20px; height: 20px;"></td> <td style="width: 20px; height: 20px;">0</td> <td style="width: 20px; height: 20px;">1</td> <td style="width: 20px; height: 20px;">2</td> <td style="width: 20px; height: 20px;">3</td> <td style="width: 20px; height: 20px;">4</td> <td style="width: 20px; height: 20px;">5</td> <td style="width: 20px; height: 20px;">6</td> <td style="width: 20px; height: 20px;">7</td> <td style="width: 20px; height: 20px;">8</td> <td style="width: 20px; height: 20px;">9</td> <td style="width: 20px; height: 20px;">10</td> <td style="width: 20px; height: 20px;">11</td> <td style="width: 20px; height: 20px;">12</td> <td style="width: 20px; height: 20px;">13</td> <td style="width: 20px; height: 20px;">14</td> <td style="width: 20px; height: 20px;">15</td> </tr> <tr> <td style="width: 20px; height: 20px;"></td> <td style="width: 20px; height: 20px;">543</td> <td style="width: 20px; height: 20px;">548</td> <td style="width: 20px; height: 20px;">553</td> <td style="width: 20px; height: 20px;">558</td> <td style="width: 20px; height: 20px;">563</td> <td style="width: 20px; height: 20px;">568</td> <td style="width: 20px; height: 20px;">573</td> <td style="width: 20px; height: 20px;">578</td> <td style="width: 20px; height: 20px;">583</td> <td style="width: 20px; height: 20px;">588</td> <td style="width: 20px; height: 20px;">593</td> <td style="width: 20px; height: 20px;">598</td> <td style="width: 20px; height: 20px;">603</td> <td style="width: 20px; height: 20px;">608</td> <td style="width: 20px; height: 20px;">613</td> <td style="width: 20px; height: 20px;">618</td> </tr> <tr> <td style="width: 20px; height: 20px; vertical-align: middle;">Start history during errors</td> <td style="width: 20px; height: 20px;">Md.7</td> <td style="width: 20px; height: 20px;">Md.8</td> <td style="width: 20px; height: 20px;">Md.9</td> <td style="width: 20px; height: 20px;">Md.10</td> <td style="width: 20px; height: 20px;">Md.11</td> <td style="width: 20px; height: 20px;"></td> <td style="width: 20px; height: 20px;"></td> <td style="width: 20px; height: 20px;"></td> <td style="width: 20px; height: 20px;"></td> <td style="width: 20px; height: 20px;"></td> <td style="width: 20px; height: 20px;"></td> <td style="width: 20px; height: 20px;"></td> <td style="width: 20px; height: 20px;"></td> <td style="width: 20px; height: 20px;"></td> <td style="width: 20px; height: 20px;"></td> <td style="width: 20px; height: 20px;"></td> </tr> <tr> <td style="width: 20px; height: 20px;"></td> <td style="width: 20px; height: 20px;">Start axis</td> <td style="width: 20px; height: 20px;">Operation type</td> <td style="width: 20px; height: 20px;">Start time (Hour: minute)</td> <td style="width: 20px; height: 20px;">Start time (Second: 100ms)</td> <td style="width: 20px; height: 20px;">Error judgment</td> <td style="width: 20px; height: 20px;"></td> <td style="width: 20px; height: 20px;"></td> <td style="width: 20px; height: 20px;"></td> <td style="width: 20px; height: 20px;"></td> <td style="width: 20px; height: 20px;"></td> <td style="width: 20px; height: 20px;"></td> <td style="width: 20px; height: 20px;"></td> <td style="width: 20px; height: 20px;"></td> <td style="width: 20px; height: 20px;"></td> <td style="width: 20px; height: 20px;"></td> <td style="width: 20px; height: 20px;"></td> </tr> <tr> <td style="width: 20px; height: 20px;"></td> <td style="width: 20px; height: 20px;">543</td> <td style="width: 20px; height: 20px;">544</td> <td style="width: 20px; height: 20px;">545</td> <td style="width: 20px; height: 20px;">546</td> <td style="width: 20px; height: 20px;">547</td> <td style="width: 20px; height: 20px;">548</td> <td style="width: 20px; height: 20px;">549</td> <td style="width: 20px; height: 20px;">550</td> <td style="width: 20px; height: 20px;">551</td> <td style="width: 20px; height: 20px;">552</td> <td style="width: 20px; height: 20px;">553</td> <td style="width: 20px; height: 20px;">554</td> <td style="width: 20px; height: 20px;">555</td> <td style="width: 20px; height: 20px;">556</td> <td style="width: 20px; height: 20px;">557</td> <td style="width: 20px; height: 20px;">558</td> </tr> </table>			0	1	2	3	4	5	6	7	8	9	10	11	12	13	14	15		0	1	2	3	4	5	6	7	8	9	10	11	12	13	14	15		543	548	553	558	563	568	573	578	583	588	593	598	603	608	613	618	Start history during errors	Md.7	Md.8	Md.9	Md.10	Md.11													Start axis	Operation type	Start time (Hour: minute)	Start time (Second: 100ms)	Error judgment													543	544	545	546	547	548	549	550	551	552	553	554	555	556	557	558
	0	1	2	3	4	5	6	7	8	9	10	11	12	13	14	15																																																																																								
	0	1	2	3	4	5	6	7	8	9	10	11	12	13	14	15																																																																																								
	543	548	553	558	563	568	573	578	583	588	593	598	603	608	613	618																																																																																								
Start history during errors	Md.7	Md.8	Md.9	Md.10	Md.11																																																																																																			
	Start axis	Operation type	Start time (Hour: minute)	Start time (Second: 100ms)	Error judgment																																																																																																			
	543	544	545	546	547	548	549	550	551	552	553	554	555	556	557	558																																																																																								
0000	<div style="display: flex; justify-content: center; gap: 20px;"> <div style="text-align: center;"> <p>↑</p> <p>Item</p> </div> <div style="text-align: center;"> <p>↑</p> <p>Buffer memory address</p> </div> </div> <ul style="list-style-type: none"> • A "pointer No." is assigned to each block of buffer memory that configures one start history. <p>Example)</p> <p>Pointer No. 0 = Buffer memory 543 to 547</p> <p>Pointer No. 1 = Buffer memory 548 to 552</p> <p>Pointer No. 2 = Buffer memory 553 to 557</p> <p style="text-align: center;">⋮</p> <ul style="list-style-type: none"> • The history is stored in order in pointer No. "0" to "15". If the No. of history items exceeds this, the history will return to "0" and be stored in order. (When newly storing history items, the previous history will be cleared.) 																																																																																																							
0000H																																																																																																								
0	623																																																																																																							

Storage item	Storage details	Reading the monitor value
<p>Md.19 Axis in which the error occurred</p>	<p>The axis No. for which an error was detected is stored.</p>	<p>■ Monitoring is carried out with a decimal.</p> <p>Monitor value  ● Storage value 1: Axis 1 2: Axis 2 3: Axis 3</p>
<p>Md.20 Axis error No.</p>	<p>The axis error No. is stored</p>	<p>■ Monitoring is carried out with a decimal.</p> <p>Monitor value  ● Error No. Refer to section "14.2 List of errors" for details on the error Nos. (error codes).</p>
<p>Md.21 Axis error occurrence time (Hour: minute)</p>	<p>The axis error detection time is stored. (Software clock data created by system in AD75.)</p>	<p>■ Monitoring is carried out with a hexadecimal.</p> <p>Buffer memory (stored with BCD code)</p> <p></p> <p>Monitor value  00 to 23 (hour) 00 to 59 (minute)</p>
<p>Md.22 Axis error occurrence time (Second: 100 ms)</p>	<p>The axis error detection time is stored. (Software clock data created by system in AD75.)</p>	<p>■ Monitoring is carried out with a hexadecimal.</p> <p>Buffer memory (stored with BCD code)</p> <p></p> <p>Monitor value  00 to 59 (second) 00 to 09 (100 ms)</p>
<p>Md.23 Error history pointer</p>	<p>The pointer No. following the pointer No. where the latest error history is stored is indicated.</p>	<p>■ Monitoring is carried out with a decimal.</p> <p>Monitor value  ● Storage value (Pointer No.) 0 to 15</p>

Error history (up to 16 items can be stored)

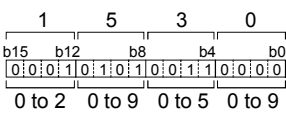
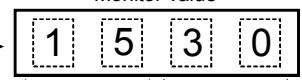
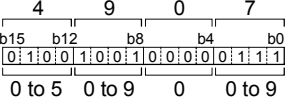
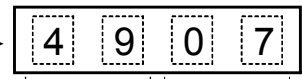
Default value	Storage buffer memory address (common for axis 1 to axis 3)																																																																																							
0	<div style="text-align: center;"> <table border="1" style="margin: auto;"> <tr> <td style="padding: 5px;">Md.23</td> <td style="padding: 5px;">Error history pointer</td> <td style="padding: 5px;">688</td> </tr> </table> <p style="text-align: center;">▲ The pointer No. following the pointer No. where the latest error history is stored.</p> </div>		Md.23	Error history pointer	688																																																																																			
Md.23	Error history pointer	688																																																																																						
0	<p>Pointer No. ↓</p> <table border="1" style="width: 100%; border-collapse: collapse;"> <thead> <tr> <th style="width: 15%;">Pointer No.</th> <th style="width: 10%;">0</th> <th style="width: 10%;">1</th> <th style="width: 10%;">2</th> <th style="width: 10%;">3</th> <th style="width: 10%;">4</th> <th style="width: 10%;">5</th> <th style="width: 10%;">6</th> <th style="width: 10%;">7</th> <th style="width: 10%;">8</th> <th style="width: 10%;">9</th> <th style="width: 10%;">10</th> <th style="width: 10%;">11</th> <th style="width: 10%;">12</th> <th style="width: 10%;">13</th> <th style="width: 10%;">14</th> <th style="width: 10%;">15</th> </tr> </thead> <tbody> <tr> <td rowspan="4" style="writing-mode: vertical-rl; transform: rotate(180deg);">Error history</td> <td style="padding: 5px;">Md.19 Axis in which the error occurred</td> <td style="padding: 5px;">624</td> <td style="padding: 5px;">628</td> <td style="padding: 5px;">632</td> <td style="padding: 5px;">636</td> <td style="padding: 5px;">640</td> <td style="padding: 5px;">644</td> <td style="padding: 5px;">648</td> <td style="padding: 5px;">652</td> <td style="padding: 5px;">656</td> <td style="padding: 5px;">660</td> <td style="padding: 5px;">664</td> <td style="padding: 5px;">668</td> <td style="padding: 5px;">672</td> <td style="padding: 5px;">676</td> <td style="padding: 5px;">680</td> <td style="padding: 5px;">684</td> </tr> <tr> <td style="padding: 5px;">Md.20 Axis error No.</td> <td style="padding: 5px;">625</td> <td style="padding: 5px;">629</td> <td style="padding: 5px;">633</td> <td style="padding: 5px;">637</td> <td style="padding: 5px;">641</td> <td style="padding: 5px;">645</td> <td style="padding: 5px;">649</td> <td style="padding: 5px;">653</td> <td style="padding: 5px;">657</td> <td style="padding: 5px;">661</td> <td style="padding: 5px;">665</td> <td style="padding: 5px;">669</td> <td style="padding: 5px;">673</td> <td style="padding: 5px;">677</td> <td style="padding: 5px;">681</td> <td style="padding: 5px;">685</td> </tr> <tr> <td style="padding: 5px;">Md.21 Axis error occurrence time (Hour: minute)</td> <td style="padding: 5px;">626</td> <td style="padding: 5px;">630</td> <td style="padding: 5px;">634</td> <td style="padding: 5px;">638</td> <td style="padding: 5px;">642</td> <td style="padding: 5px;">646</td> <td style="padding: 5px;">650</td> <td style="padding: 5px;">654</td> <td style="padding: 5px;">658</td> <td style="padding: 5px;">662</td> <td style="padding: 5px;">666</td> <td style="padding: 5px;">670</td> <td style="padding: 5px;">674</td> <td style="padding: 5px;">678</td> <td style="padding: 5px;">682</td> <td style="padding: 5px;">686</td> </tr> <tr> <td style="padding: 5px;">Md.21 Axis error occurrence time (Second: 100ms)</td> <td style="padding: 5px;">627</td> <td style="padding: 5px;">631</td> <td style="padding: 5px;">635</td> <td style="padding: 5px;">639</td> <td style="padding: 5px;">643</td> <td style="padding: 5px;">647</td> <td style="padding: 5px;">651</td> <td style="padding: 5px;">655</td> <td style="padding: 5px;">659</td> <td style="padding: 5px;">663</td> <td style="padding: 5px;">667</td> <td style="padding: 5px;">671</td> <td style="padding: 5px;">675</td> <td style="padding: 5px;">679</td> <td style="padding: 5px;">683</td> <td style="padding: 5px;">687</td> </tr> </tbody> </table> <p style="text-align: center;"> ↑ Item ↑ Buffer memory address </p>		Pointer No.	0	1	2	3	4	5	6	7	8	9	10	11	12	13	14	15	Error history	Md.19 Axis in which the error occurred	624	628	632	636	640	644	648	652	656	660	664	668	672	676	680	684	Md.20 Axis error No.	625	629	633	637	641	645	649	653	657	661	665	669	673	677	681	685	Md.21 Axis error occurrence time (Hour: minute)	626	630	634	638	642	646	650	654	658	662	666	670	674	678	682	686	Md.21 Axis error occurrence time (Second: 100ms)	627	631	635	639	643	647	651	655	659	663	667	671	675	679	683	687
Pointer No.	0	1	2	3	4	5	6	7	8	9	10	11	12	13	14	15																																																																								
Error history	Md.19 Axis in which the error occurred	624	628	632	636	640	644	648	652	656	660	664	668	672	676	680	684																																																																							
	Md.20 Axis error No.	625	629	633	637	641	645	649	653	657	661	665	669	673	677	681	685																																																																							
	Md.21 Axis error occurrence time (Hour: minute)	626	630	634	638	642	646	650	654	658	662	666	670	674	678	682	686																																																																							
	Md.21 Axis error occurrence time (Second: 100ms)	627	631	635	639	643	647	651	655	659	663	667	671	675	679	683	687																																																																							
0000	<ul style="list-style-type: none"> • A "pointer No." is assigned to each block of buffer memory that configures one start history. <p>Example)</p> <p style="margin-left: 20px;">Pointer No. 0 = Buffer memory 624 to 627</p> <p style="margin-left: 20px;">Pointer No. 1 = Buffer memory 628 to 631</p> <p style="margin-left: 20px;">Pointer No. 2 = Buffer memory 632 to 635</p> <p style="margin-left: 20px;">⋮</p> <ul style="list-style-type: none"> • The history is stored in order in pointer No. "0" to "15". If the No. of history items exceeds this, the history will return to "0" and be stored in order. (When newly storing history items, the previous history will be cleared.) 																																																																																							
0	688																																																																																							

	Storage item	Storage details	Reading the monitor value	
Warning history (up to 16 items can be stored)	<p>Md.24 Axis in which the warning occurred</p>	<p>The axis No. for which a warning was detected is stored.</p>	<p>■ Monitoring is carried out with a decimal.</p> <p>Monitor value  ● Storage value 1: Axis 1 2: Axis 2 3: Axis 3</p>	
	<p>Md.25 Axis warning No.</p>	<p>The axis warning No. is stored.</p>	<p>■ Monitoring is carried out with a decimal.</p> <p>Monitor value  ● Warning No. Refer to section "14.3 List of warnings" for details on the warning Nos. (error codes).</p>	
	<p>Md.26 Axis warning occurrence time (Hour: minute)</p>	<p>The axis warning detection time is stored. (Software clock data created by system in AD75.)</p>	<p>■ Monitoring is carried out with a hexadecimal.</p> <p>Buffer memory (stored with BCD code)</p> <p> → Monitor value  00 to 23 (hour) 00 to 59 (minute)</p>	
	<p>Md.27 Axis warning occurrence time (Second: 100 ms)</p>	<p>The axis warning detection time is stored. (Software clock data created by system in AD75.)</p>	<p>■ Monitoring is carried out with a hexadecimal.</p> <p>Buffer memory (stored with BCD code)</p> <p> → Monitor value  00 to 59 (second) 00 to 09 (100 ms)</p>	
	<p>Md.28 Warning history pointer</p>	<p>The pointer No. following the pointer No. where the latest warning history is stored is indicated.</p>	<p>■ Monitoring is carried out with a decimal.</p> <p>Monitor value  ● Storage value (Pointer No.) 0 to 15</p>	



Default value	Storage buffer memory address (common for axis 1 to axis 3)																																																																																						
0	<div style="text-align: center;"> <table border="1" style="margin: auto;"> <tr> <td style="padding: 2px;">Md.28</td> <td style="padding: 2px;">Warning history pointer</td> <td style="padding: 2px;">753</td> </tr> </table> </div>		Md.28	Warning history pointer	753																																																																																		
Md.28	Warning history pointer	753																																																																																					
0	<p>Pointer No. ↓</p> <table border="1" style="margin: auto;"> <tr> <td style="text-align: center;">Pointer No.</td> <td>0</td><td>1</td><td>2</td><td>3</td><td>4</td><td>5</td><td>6</td><td>7</td><td>8</td><td>9</td><td>10</td><td>11</td><td>12</td><td>13</td><td>14</td><td>15</td> </tr> <tr> <td style="text-align: center;">Md.24 Axis in which the warning occurred</td> <td>689</td><td>693</td><td>697</td><td>701</td><td>705</td><td>709</td><td>713</td><td>717</td><td>721</td><td>725</td><td>729</td><td>733</td><td>737</td><td>741</td><td>745</td><td>749</td> </tr> <tr> <td style="text-align: center;">Md.25 Axis warning No.</td> <td>690</td><td>694</td><td>698</td><td>702</td><td>706</td><td>710</td><td>714</td><td>718</td><td>722</td><td>726</td><td>730</td><td>734</td><td>738</td><td>742</td><td>746</td><td>750</td> </tr> <tr> <td style="text-align: center;">Md.26 Axis warning occurrence time (Hour: minute)</td> <td>691</td><td>695</td><td>699</td><td>703</td><td>707</td><td>711</td><td>715</td><td>719</td><td>723</td><td>727</td><td>731</td><td>735</td><td>739</td><td>743</td><td>747</td><td>751</td> </tr> <tr> <td style="text-align: center;">Md.27 Axis warning occurrence time (Second: 100ms)</td> <td>692</td><td>696</td><td>700</td><td>704</td><td>708</td><td>712</td><td>716</td><td>720</td><td>724</td><td>728</td><td>732</td><td>736</td><td>740</td><td>744</td><td>748</td><td>752</td> </tr> </table> <p style="text-align: center;">↑ Item ↑ Buffer memory address</p>		Pointer No.	0	1	2	3	4	5	6	7	8	9	10	11	12	13	14	15	Md.24 Axis in which the warning occurred	689	693	697	701	705	709	713	717	721	725	729	733	737	741	745	749	Md.25 Axis warning No.	690	694	698	702	706	710	714	718	722	726	730	734	738	742	746	750	Md.26 Axis warning occurrence time (Hour: minute)	691	695	699	703	707	711	715	719	723	727	731	735	739	743	747	751	Md.27 Axis warning occurrence time (Second: 100ms)	692	696	700	704	708	712	716	720	724	728	732	736	740	744	748	752
Pointer No.	0	1	2	3	4	5	6	7	8	9	10	11	12	13	14	15																																																																							
Md.24 Axis in which the warning occurred	689	693	697	701	705	709	713	717	721	725	729	733	737	741	745	749																																																																							
Md.25 Axis warning No.	690	694	698	702	706	710	714	718	722	726	730	734	738	742	746	750																																																																							
Md.26 Axis warning occurrence time (Hour: minute)	691	695	699	703	707	711	715	719	723	727	731	735	739	743	747	751																																																																							
Md.27 Axis warning occurrence time (Second: 100ms)	692	696	700	704	708	712	716	720	724	728	732	736	740	744	748	752																																																																							
0000	<ul style="list-style-type: none"> • A "pointer No." is assigned to each block of buffer memory that configures one start history. <p>Example)</p> <p style="margin-left: 20px;">Pointer No. 0 = Buffer memory 689 to 692 Pointer No. 1 = Buffer memory 693 to 696 Pointer No. 2 = Buffer memory 697 to 700 ⋮</p> <ul style="list-style-type: none"> • The history is stored in order in pointer No. "0" to "15". If the No. of history items exceeds this, the history will return to "0" and be stored in order. (When newly storing history items, the previous history will be cleared.) 																																																																																						
0	753																																																																																						

5.6.2 Axis monitor data

Storage item	Storage details
<p>[Md.29] Current feed value</p>	<p>The currently commanded address is stored. (Different from the actual motor position during operation)</p> <p>The current position address is stored.</p> <ul style="list-style-type: none"> • Update timing : 56.8ms • The zero point address is stored when the machine zero point return is completed. • When the current value is changed with the current value charge function, the changed value is stored.
<p>[Md.30] Machine feed value</p>	<p>The address of the current position obtained with the machine coordinates is stored. (Different from the actual motor position during operation)</p> <ul style="list-style-type: none"> • Machine coordinates: Characteristic coordinates determined with machine • Update timing: 56.8ms
<p>[Md.31] Feedrate</p>	<p>The output speed commanded by the AD75 is stored. (May be different from the actual motor speed during operation)</p> <ul style="list-style-type: none"> • During interpolation operation, the speed is stored in the following manner. Reference axis : Composite speed or reference axis speed (Set with [Pr.21]) Interpolation axis : 0 • Update timing: 56.8ms
<p>[Md.32] Valid M code</p>	<p>The currently valid M code (set in the positioning data currently operating) is stored.</p> <ul style="list-style-type: none"> • Update timing : When M code ON signal turns ON
<p>[Md.33] Axis error No.</p>	<p>When an axis error is detected, the error code corresponding to the error details is stored.</p> <ul style="list-style-type: none"> • The latest error code is always stored. (When a new axis error occurs, the error code is overwritten.) • When "axis error reset" (axis control data) turns ON, the axis error No. is cleared (set to 0).

Reading the monitor value	Default value	Storage buffer memory address																						
		Axis 1	Axis 2	Axis 3																				
<p>■ Monitoring is carried out with a hexadecimal.</p> <p>Low-order buffer memory Example) 800 b15 b12 b8 b4 b0 E F G H</p> <p>High-order buffer memory Example) 801 b31 b28 b24 b20 b16 A B C D</p> <p>Monitor value</p> <p>◇ Sorting</p> <p>(High-order buffer memory) (Low-order buffer memory) A B C D E F G H</p> <p>◇ Converted from hexadecimal to decimal</p> <p>Decimal integer value R</p> <p>◇ Unit conversion $R \times 10^n$</p> <p>Actual value</p> <ul style="list-style-type: none"> [Md.29] Current feed value [Md.30] Machine feed value [Md.31] Feedrate <p>• Unit conversion table ([Md.29] [Md.30])</p> <table border="1"> <thead> <tr> <th>n</th> <th>Unit</th> </tr> </thead> <tbody> <tr> <td>-1</td> <td>mm</td> </tr> <tr> <td>-5</td> <td>inch</td> </tr> <tr> <td>-5</td> <td>degree</td> </tr> <tr> <td>0</td> <td>pulse</td> </tr> </tbody> </table> <p>• Unit conversion table ([Md.31])</p> <table border="1"> <thead> <tr> <th>n</th> <th>Unit</th> </tr> </thead> <tbody> <tr> <td>-2</td> <td>mm/min</td> </tr> <tr> <td>-3</td> <td>inch/min</td> </tr> <tr> <td>-3</td> <td>degree/min</td> </tr> <tr> <td>0</td> <td>pulse/s</td> </tr> </tbody> </table>	n	Unit	-1	mm	-5	inch	-5	degree	0	pulse	n	Unit	-2	mm/min	-3	inch/min	-3	degree/min	0	pulse/s	0000H	800 801	900 901	1000 1001
n	Unit																							
-1	mm																							
-5	inch																							
-5	degree																							
0	pulse																							
n	Unit																							
-2	mm/min																							
-3	inch/min																							
-3	degree/min																							
0	pulse/s																							
	0000H	802 803	902 903	1002 1003																				
	0000H	804 805	904 905	1004 1005																				
<p>■ Monitoring is carried out with a decimal.</p> <p>Monitor value</p> <p>• M code No. (0 to 32767)</p>	0	806	906	1006																				
<p>■ Monitoring is carried out with a decimal.</p> <p>Monitor value</p> <p>• Error No. Refer to section "14.2 List of errors" for details on the error Nos. (error codes).</p>	0	807	907	1007																				

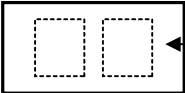
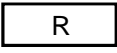
Storage item	Storage details
<p>[Md.34] Axis warning No.</p>	<p>When an axis warning is detected, the warning code corresponding to the details of the warning is stored.</p> <ul style="list-style-type: none"> • The latest warning code is always stored. (When a new axis warning occurs, the warning code is overwritten.) • When "[Cd.12] Axis error reset" (axis control data) turns ON, the axis warning No. is cleared (set to 0).
<p>[Md.35] Axis operation status</p>	<p>The axis operation state is stored.</p>
<p>[Md.36] Current speed</p>	<p>"[Da.7] Command speed" of positioning data currently execution is stored.</p> <ul style="list-style-type: none"> • When "-1" is set for "[Da.7] Command speed": The command speed of the previous positioning data is stored. • When a value other than "-1" is set for "[Da.7] Command speed": The command speed of the positioning data currently being executed is stored. • When the speed change function is executed : "[Cd.16] New speed value" is stored. (For details of the speed change function, refer to Section 12.5.1.)

Reading the monitor value	Default value	Storage buffer memory address												
		Axis 1	Axis 2	Axis 3										
<p>■ Monitoring is carried out with a decimal.</p> <p>Monitor value  ● Warning No. Refer to section "14.3 List of warnings" for details on the warning Nos. (warning codes).</p>	0	808	908	1008										
<p>■ Monitoring is carried out with a decimal.</p> <p>Monitor value  ● Axis operation state</p> <ul style="list-style-type: none"> -4 : Step error occurring -3 : Step stopped -2 : In step wait -1 : Error occurring 0 : Waiting 1 : Stopped 2 : Interpolating 3 : In JOG operation 4 : In manual pulse generator operation 5 : Analyzing 6 : Special start waiting 7 : In zero point return 8 : In position control 9 : In speed control 10 : In speed control for speed/position control 11 : In position control for speed/position control 	0	809	909	1009										
<p>■ Monitoring is carried out with a decimal.</p> <p>Monitor value  (Decimal integer value)</p> <p>◇ Unit conversion $R \times 10^n$</p> <p>Actual value </p> <p>● Unit conversion table (Md.36)</p> <table border="1" data-bbox="726 1713 949 1870"> <thead> <tr> <th>n</th> <th>Unit</th> </tr> </thead> <tbody> <tr> <td>-2</td> <td>mm/min</td> </tr> <tr> <td>-3</td> <td>inch/min</td> </tr> <tr> <td>-3</td> <td>degree/min</td> </tr> <tr> <td>0</td> <td>pulse/s</td> </tr> </tbody> </table>	n	Unit	-2	mm/min	-3	inch/min	-3	degree/min	0	pulse/s	0	810	910	1010
n	Unit													
-2	mm/min													
-3	inch/min													
-3	degree/min													
0	pulse/s													

Storage item	Storage details	
<p>[Md.37] Axis feedrate</p>	<ul style="list-style-type: none"> • The output speed commanded by the AD75 to each axis is stored. (May be different from the actual motor speed.) • "0" is stored when the axis is stopped. 	
<p>[Md.38] Speed/position changeover control positioning amount</p>	<ul style="list-style-type: none"> • The value set as the movement amount for the position control to end after changing to position control with the speed/position changeover control is stored. 	
<p>[Md.39] External input/output signal</p>	<p>The ON/OFF state of the external input/output signal is stored. The following items are stored.</p> <ul style="list-style-type: none"> • Drive unit READY signal • Zero point signal • In-position signal • Near-point signal • Stop signal • Upper limit signal • Lower limit signal • External start signal • Speed/position changeover signal • Deviation counter clear signal 	

Reading the monitor value	Default value	Storage buffer memory address																										
		Axis 1	Axis 2	Axis 3																								
<p>■ Monitoring is carried out with a hexadecimal.</p> <p>Low-order buffer memory Example) 812 b15 b12 b8 b4 b0 E F G H</p> <p>High-order buffer memory Example) 813 b31 b28 b24 b20 b16 A B C D</p> <p>Monitor value: E F G H, A B C D</p> <p>◇ Sorting</p> <p>(High-order buffer memory) (Low-order buffer memory) A B C D E F G H</p> <p>◇ Converted from hexadecimal to decimal</p> <p>Decimal integer value: R</p> <p>◇ Unit conversion $R \times 10^n$</p> <p>Actual value: Md.37 Axis feedrate Md.38 Speed/position changeover control positioning amount</p> <p>• Unit conversion table (Md.37)</p> <table border="1"> <thead> <tr> <th>n</th> <th>Unit</th> </tr> </thead> <tbody> <tr> <td>-2</td> <td>mm/min</td> </tr> <tr> <td>-3</td> <td>inch/min</td> </tr> <tr> <td>-3</td> <td>degree/min</td> </tr> <tr> <td>0</td> <td>pulse/s</td> </tr> </tbody> </table> <p>• Unit conversion table (Md.38)</p> <table border="1"> <thead> <tr> <th>n</th> <th>Unit</th> </tr> </thead> <tbody> <tr> <td>-1</td> <td>mm</td> </tr> <tr> <td>-5</td> <td>inch</td> </tr> <tr> <td>-5</td> <td>degree</td> </tr> <tr> <td>0</td> <td>pulse</td> </tr> </tbody> </table>	n	Unit	-2	mm/min	-3	inch/min	-3	degree/min	0	pulse/s	n	Unit	-1	mm	-5	inch	-5	degree	0	pulse	0000H	812 813	912 913	1012 1013				
n	Unit																											
-2	mm/min																											
-3	inch/min																											
-3	degree/min																											
0	pulse/s																											
n	Unit																											
-1	mm																											
-5	inch																											
-5	degree																											
0	pulse																											
<p>■ Monitoring is carried out with a hexadecimal.</p> <p>Monitor value: 0</p> <p>Buffer memory: b15 b12 b8 b4 b0 0 0 0 0 0 0 0 0 0 0 0 0 0 0 0 0</p> <p>Not used</p> <table border="1"> <thead> <tr> <th>Stored items</th> <th>Default value</th> <th>Meaning</th> </tr> </thead> <tbody> <tr> <td>b0 Drive unit READY signal</td> <td>0</td> <td rowspan="10">0: OFF 1: ON</td> </tr> <tr> <td>b1 Zero point signal</td> <td>0</td> </tr> <tr> <td>b2 In-position signal</td> <td>0</td> </tr> <tr> <td>b3 Near-point signal</td> <td>0</td> </tr> <tr> <td>b4 Stop signal</td> <td>0</td> </tr> <tr> <td>b5 Upper limit signal</td> <td>0</td> </tr> <tr> <td>b6 Lower limit signal</td> <td>0</td> </tr> <tr> <td>b7 External start signal</td> <td>0</td> </tr> <tr> <td>b8 Speed/position changeover signal</td> <td>0</td> </tr> <tr> <td>b9 Deviation counter clear signal</td> <td>0</td> </tr> </tbody> </table>	Stored items	Default value	Meaning	b0 Drive unit READY signal	0	0: OFF 1: ON	b1 Zero point signal	0	b2 In-position signal	0	b3 Near-point signal	0	b4 Stop signal	0	b5 Upper limit signal	0	b6 Lower limit signal	0	b7 External start signal	0	b8 Speed/position changeover signal	0	b9 Deviation counter clear signal	0	0000H	816	916	1016
Stored items	Default value	Meaning																										
b0 Drive unit READY signal	0	0: OFF 1: ON																										
b1 Zero point signal	0																											
b2 In-position signal	0																											
b3 Near-point signal	0																											
b4 Stop signal	0																											
b5 Upper limit signal	0																											
b6 Lower limit signal	0																											
b7 External start signal	0																											
b8 Speed/position changeover signal	0																											
b9 Deviation counter clear signal	0																											

Storage item	Storage details
<p>[Md.40] Status</p>	<p>The ON/OFF state of each flag is stored. The following items are stored.</p> <ul style="list-style-type: none"> ● In speed control flag : This signal is used to judge whether the system is in speed control or position control. This turns ON during speed control. This signal is OFF when the power is turned ON, during position control, during JOG operation and during manual pulse generator operation. During speed/position changeover control, this signal turns ON during speed control, and turns OFF when speed control to position control changeover is executed with the speed/position changeover signal. ● Speed/position changeover latch flag : This signal is used for the movement amount change enable interlock during speed/position changeover control. This signal turns ON when position control is changed to during speed/position changeover control. This signal turns OFF when the next positioning data is executed, during JOG operation and during manual pulse generator operation. ● Command in-position flag : This signal turns ON when the remaining distance is less than the command in-position range (set with the detailed parameters). The position is checked every 56.8ms, and is not checked during speed control or controlling speed of speed/position changeover control. This signal turns OFF during axis movement in each operation. ● Zero point return request flag : This signal turns ON when the drive unit READY signal is OFF, when the PLC READY signal [Y1D] is ON and during machine zero point return start. This signal turns OFF when machine zero point return is completed. ● Zero point return complete flag : This signal turns ON when machine zero point return is completed normally. It turns OFF when operation is started and when the drive unit READY signal is OFF. ● Axis warning detection : This signal turns ON when an axis warning occurs, and turns OFF when axis error reset is turned ON. ● Speed change 0 flag : This signal turns ON when a speed change is requested at the new speed value 0, and turns OFF when the speed change is requested at a new speed value other than 0. ● Zero point absolute position overflow/underflow flag : This turns ON if the zero point absolute position overflows or underflows when the current value change function is executed. This turns OFF when the current value change function is executed in the reverse direction of the flowing direction.
<p>[Md.41] Target value</p>	<p>The target value ([Da.5] Positioning address/movement amount) during positioning operation is stored.</p> <ul style="list-style-type: none"> • During positioning start : The "[Da.5] Positioning address/movement amount" is stored. • Other times : "0" is stored.

Reading the monitor value	Default value	Storage buffer memory address																									
		Axis 1	Axis 2	Axis 3																							
<p>■ Monitoring is carried out with a hexadecimal.</p> <table border="1"> <thead> <tr> <th>Stored items</th> <th>Default value</th> <th>Meaning</th> </tr> </thead> <tbody> <tr> <td>b0</td> <td>0</td> <td rowspan="8">0: OFF 1: ON</td> </tr> <tr> <td>b1</td> <td>0</td> </tr> <tr> <td>b2</td> <td>0</td> </tr> <tr> <td>b3</td> <td>0</td> </tr> <tr> <td>b4</td> <td>0</td> </tr> <tr> <td>b9</td> <td>0</td> </tr> <tr> <td>b10</td> <td>0</td> </tr> <tr> <td>b11</td> <td>0</td> </tr> <tr> <td>b12</td> <td>0</td> <td>Zero point absolute position underflow flag</td> </tr> </tbody> </table>	Stored items	Default value	Meaning	b0	0	0: OFF 1: ON	b1	0	b2	0	b3	0	b4	0	b9	0	b10	0	b11	0	b12	0	Zero point absolute position underflow flag	0000H	817	917	1017
Stored items	Default value	Meaning																									
b0	0	0: OFF 1: ON																									
b1	0																										
b2	0																										
b3	0																										
b4	0																										
b9	0																										
b10	0																										
b11	0																										
b12	0	Zero point absolute position underflow flag																									
<p>■ Monitoring is carried out with a decimal.</p> <table border="1"> <thead> <tr> <th>n</th> <th>Unit</th> </tr> </thead> <tbody> <tr> <td>-1</td> <td>mm</td> </tr> <tr> <td>-5</td> <td>inch</td> </tr> <tr> <td>-5</td> <td>degree</td> </tr> <tr> <td>0</td> <td>pulse</td> </tr> </tbody> </table>	n	Unit	-1	mm	-5	inch	-5	degree	0	pulse	0	818 819	918 919	1018 1019													
n	Unit																										
-1	mm																										
-5	inch																										
-5	degree																										
0	pulse																										



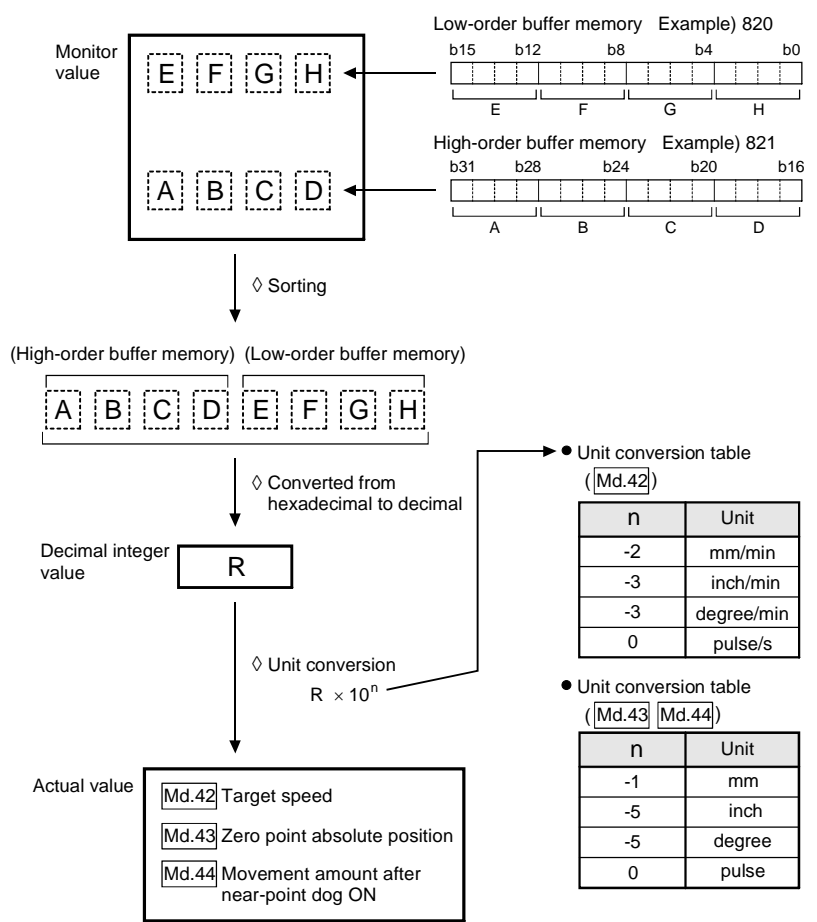
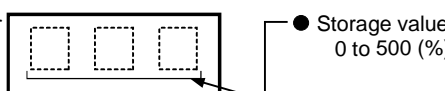

Storage item	Storage details
<p>[Md.42] Target speed</p>	<ul style="list-style-type: none"> • During operation with positioning data : The actual target speed, considering the override and speed limit value, etc., is stored. "0" is stored when positioning is completed. • During interpolation : The composite speed or reference axis speed is stored in the reference axis address, and "0" is stored in the interpolation axis address. • During JOG operation : The actual target speed, considering the JOG speed limit value for the JOG speed, is stored. • During manual pulse generator operation : "0" is stored.
<p>[Md.43] Zero point absolute position</p>	<ul style="list-style-type: none"> • The "zero point absolute position" address is stored. • "0" is stored when the power is turned ON, and the zero point return basic parameter "[Pr.47] Zero point address" is stored when the machine zero point return is completed. • The zero point absolute position value is changed when the current value charge function is executed.
<p>[Md.44] Movement amount after near-point dog ON</p>	<ul style="list-style-type: none"> • "0" is stored when machine zero point return starts. • After machine zero point return starts, the movement amount from the near-point dog ON to the machine zero point return completion is stored. (Movement amount: Movement amount to machine zero point return completion using near-point dog ON as "0".) • "0" is always stored when not using the near-point dog, or when using the stopper stop method.
<p>[Md.45] Torque limit stored value</p>	<p>The "[Pr.18] Torque limit setting value" or "[Cd.30] New torque value" is stored.</p> <ul style="list-style-type: none"> • During positioning start, JOG operation start, manual pulse generator operation ...The "[Pr.18] Torque limit setting value" is stored. • When value is changed to "[Cd.30] New torque value" during operation ...The "[Cd.30] New torque value" is stored.

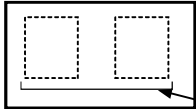
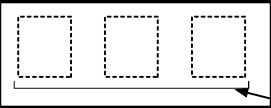
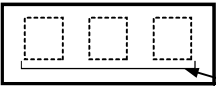
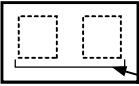
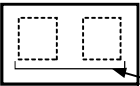
Reading the monitor value	Default value	Storage buffer memory address																						
		Axis 1	Axis 2	Axis 3																				
<p>■ Monitoring is carried out with a hexadecimal display.</p> 	0000H	820 821	920 921	1020 1021																				
<p>◇ Sorting</p> <p>(High-order buffer memory) (Low-order buffer memory)</p> <p>◇ Converted from hexadecimal to decimal</p> <p>Decimal integer value</p> <p>R</p> <p>◇ Unit conversion $R \times 10^n$</p> <p>Actual value</p> <ul style="list-style-type: none"> [Md.42] Target speed [Md.43] Zero point absolute position [Md.44] Movement amount after near-point dog ON <p>• Unit conversion table ([Md.42])</p> <table border="1"> <thead> <tr> <th>n</th> <th>Unit</th> </tr> </thead> <tbody> <tr> <td>-2</td> <td>mm/min</td> </tr> <tr> <td>-3</td> <td>inch/min</td> </tr> <tr> <td>-3</td> <td>degree/min</td> </tr> <tr> <td>0</td> <td>pulse/s</td> </tr> </tbody> </table> <p>• Unit conversion table ([Md.43] [Md.44])</p> <table border="1"> <thead> <tr> <th>n</th> <th>Unit</th> </tr> </thead> <tbody> <tr> <td>-1</td> <td>mm</td> </tr> <tr> <td>-5</td> <td>inch</td> </tr> <tr> <td>-5</td> <td>degree</td> </tr> <tr> <td>0</td> <td>pulse</td> </tr> </tbody> </table>	n	Unit	-2	mm/min	-3	inch/min	-3	degree/min	0	pulse/s	n	Unit	-1	mm	-5	inch	-5	degree	0	pulse	0000H	822 823	922 923	1022 1023
n	Unit																							
-2	mm/min																							
-3	inch/min																							
-3	degree/min																							
0	pulse/s																							
n	Unit																							
-1	mm																							
-5	inch																							
-5	degree																							
0	pulse																							
<p>■ Monitoring is carried out with a decimal display.</p> <p>Monitor value</p>  <p>• Storage value 0 to 500 (%)</p>	0	826	926	1026																				

Storage item	Storage details	
<p>[Md.46] Special start data command code setting value</p>	<ul style="list-style-type: none"> The "command code" used with special start and indicated by the start data pointer currently being executed is stored. 	
<p>[Md.47] Special start data command parameter setting value</p>	<p>The "command parameter" used with special start and indicated by the start data pointer currently being executed is stored. The stored value differs according to the value set for [Md.46].</p>	
<p>[Md.48] Start positioning data No. setting value</p>	<ul style="list-style-type: none"> The "positioning data No." indicated by the start data pointer currently being executed is stored. 	
<p>[Md.49] In speed limit flag</p>	<ul style="list-style-type: none"> If the speed exceeds the "[Pr.7] Speed limit value" due to a speed change or override, the speed limit functions, and the in speed limit flag turns ON. When the speed drops to less than "[Pr.7] Speed limit value", or when the axis stops, the in speed limit flag turns OFF. 	
<p>[Md.50] In speed change processing flag</p>	<ul style="list-style-type: none"> The speed change process flag turns ON when the speed is changed during positioning control. After the speed change process is completed or when deceleration starts with the stop signal during the speed change process, the in speed change process flag turns OFF. 	

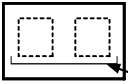
Reading the monitor value	Default value	Storage buffer memory address														
		Axis 1	Axis 2	Axis 3												
<p>■ Monitoring is carried out with a decimal display.</p> <p>Monitor value </p> <p>● Storage value 00: Block start (Normal start) 01: Condition start 02: Wait start 03: Simultaneous start 04: Stop 05: FOR loop 06: FOR condition 07: NEXT</p>	0	827	927	1027												
<p>■ Monitoring is carried out with a decimal display.</p> <p>Monitor value </p> <p>● Storage value</p> <table border="1" data-bbox="544 808 1015 1104"> <thead> <tr> <th>Md.46 setting value</th> <th>Stored contents</th> <th>Storage value</th> </tr> </thead> <tbody> <tr> <td>00 04 07</td> <td>None</td> <td>None</td> </tr> <tr> <td>01 02 03 06</td> <td>Condition data No.</td> <td>1 to 10</td> </tr> <tr> <td>05</td> <td>No. of repetitions</td> <td>0 to 255</td> </tr> </tbody> </table>	Md.46 setting value	Stored contents	Storage value	00 04 07	None	None	01 02 03 06	Condition data No.	1 to 10	05	No. of repetitions	0 to 255	0	828	928	1028
Md.46 setting value	Stored contents	Storage value														
00 04 07	None	None														
01 02 03 06	Condition data No.	1 to 10														
05	No. of repetitions	0 to 255														
<p>■ Monitoring is carried out with a decimal display.</p> <p>Monitor value </p> <p>● Storage value 1 to 600</p>	0	829	929	1029												
<p>■ Monitoring is carried out with a decimal display.</p> <p>Monitor value </p> <p>● Storage value 0: Not in speed limit (OFF) 1: In speed limit (ON)</p>	0	830	930	1030												
<p>■ Monitoring is carried out with a decimal display.</p> <p>Monitor value </p> <p>● Storage value 0: Not in speed change (OFF) 1: In speed change (ON)</p>	0	831	931	1031												

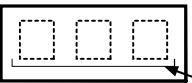
Storage item	Storage details	
<p>[Md.51] Start data pointer being executed</p>	<ul style="list-style-type: none"> • The point No. (1 to 50) of the start data currently being executed is stored. • "0" is stored when positioning is completed. 	
<p>[Md.52] Last executed positioning data No.</p>	<ul style="list-style-type: none"> • The positioning data No. executed last is stored. • The value is held until the next positioning is executed. 	
<p>[Md.53] Repeat counter</p>	<ul style="list-style-type: none"> • During "repetitive" execution, the remaining No. of repetitions is stored. • This value is decremented (-1) at the end of the repetition loop. • The loop ends when "0" is reached. • "0" is stored for an infinite loop. 	
<p>[Md.54] Positioning data No. being executed</p>	<ul style="list-style-type: none"> • The positioning data No. currently being executed is stored. • For an indirectly specified positioning data No., the data No. converted to 1 to 600 is stored. 	
<p>[Md.55] Block No. being executed</p>	<ul style="list-style-type: none"> • When controlling using the "start block data", the block No. "7000" to "7010" currently being executed is stored. • In all other cases, "0" is stored. 	
<p>[Md.56] Positioning data being executed</p>	<ul style="list-style-type: none"> • The details of the positioning data currently being executed (data of positioning data No. stored in [Md.54]) are stored in the addresses shown on the right. 	

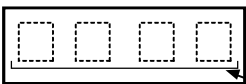
Reading the monitor value	Default value	Storage buffer memory address																																																								
		Axis 1	Axis 2	Axis 3																																																						
<p>■ Monitoring is carried out with a decimal display.</p> <p>Monitor value  ● Storage value 1 to 50</p>	0	832	932	1032																																																						
<p>■ Monitoring is carried out with a decimal display.</p> <p>Monitor value  ● Storage value 1 to 600</p>	0	833	933	1033																																																						
<p>■ Monitoring is carried out with a decimal display.</p> <p>Monitor value  ● Storage value 0 to 255</p>	0	834	934	1034																																																						
<p>■ Monitoring is carried out with a decimal display.</p> <p>Monitor value  ● Storage value 1 to 600</p>	0	835	935	1035																																																						
<p>■ Monitoring is carried out with a decimal display.</p> <p>Monitor value  ● Storage value 0, 7000 to 7010</p>	0	836	936	1036																																																						
<p>Each storage item is stored in the following storage address.</p> <table border="1" data-bbox="301 1505 880 1975"> <thead> <tr> <th colspan="3">Storage address</th> <th rowspan="2">Stored item</th> <th rowspan="2">Reference</th> </tr> <tr> <th>Axis 1</th> <th>Axis 2</th> <th>Axis 3</th> </tr> </thead> <tbody> <tr> <td>838</td> <td>938</td> <td>1038</td> <td>Positioning identifier</td> <td>Da.1 to Da.4</td> </tr> <tr> <td>839</td> <td>939</td> <td>1039</td> <td>M code</td> <td>Da.9</td> </tr> <tr> <td>840</td> <td>940</td> <td>1040</td> <td>Dwell time</td> <td>Da.8</td> </tr> <tr> <td>841</td> <td>941</td> <td>1041</td> <td>Not used</td> <td></td> </tr> <tr> <td>842</td> <td>942</td> <td>1042</td> <td rowspan="2">Command speed</td> <td rowspan="2">Da.7</td> </tr> <tr> <td>843</td> <td>943</td> <td>1043</td> </tr> <tr> <td>844</td> <td>944</td> <td>1044</td> <td>Positioning address</td> <td>Da.5</td> </tr> <tr> <td>845</td> <td>945</td> <td>1045</td> <td rowspan="2">Arc address</td> <td rowspan="2">Da.6</td> </tr> <tr> <td>846</td> <td>946</td> <td>1046</td> </tr> <tr> <td>847</td> <td>947</td> <td>1047</td> <td></td> <td></td> </tr> </tbody> </table>	Storage address			Stored item	Reference	Axis 1	Axis 2	Axis 3	838	938	1038	Positioning identifier	Da.1 to Da.4	839	939	1039	M code	Da.9	840	940	1040	Dwell time	Da.8	841	941	1041	Not used		842	942	1042	Command speed	Da.7	843	943	1043	844	944	1044	Positioning address	Da.5	845	945	1045	Arc address	Da.6	846	946	1046	847	947	1047			0	838 to 847	938 to 947	1038 to 1047
Storage address			Stored item			Reference																																																				
Axis 1	Axis 2	Axis 3																																																								
838	938	1038	Positioning identifier	Da.1 to Da.4																																																						
839	939	1039	M code	Da.9																																																						
840	940	1040	Dwell time	Da.8																																																						
841	941	1041	Not used																																																							
842	942	1042	Command speed	Da.7																																																						
843	943	1043																																																								
844	944	1044	Positioning address	Da.5																																																						
845	945	1045	Arc address	Da.6																																																						
846	946	1046																																																								
847	947	1047																																																								

5.7 List of control data

5.7.1 System control data

Setting item	Setting details
<p><input type="checkbox"/> Cd.1 Clock data setting (hour)</p>	<ul style="list-style-type: none"> • The clock data (hour) from the PLC CPU is set after the AD75 power is turned ON.
<p><input type="checkbox"/> Cd.2 Clock data setting (minute, second)</p>	<ul style="list-style-type: none"> • The clock data (minute, second) from the PLC CPU is set after the AD75 power is turned ON.
<p><input type="checkbox"/> Cd.3 Clock data writing</p>	<ul style="list-style-type: none"> • After setting the clock data in <input type="checkbox"/> Cd.1 and <input type="checkbox"/> Cd.2, when setting the data in <input type="checkbox"/> Md.5 and <input type="checkbox"/> Md.6 as the AD75 clock data, set "1". • When the setting is completed, the OS sets "0".
<p><input type="checkbox"/> Cd.4 Target axis*</p>	<ul style="list-style-type: none"> • Set the axis targeted for reading or writing.

* Cd.4 to Cd.8 are data used to transmit the positioning data between the OS memory and buffer memory. (Refer to section "7.2 Data transmission process".)

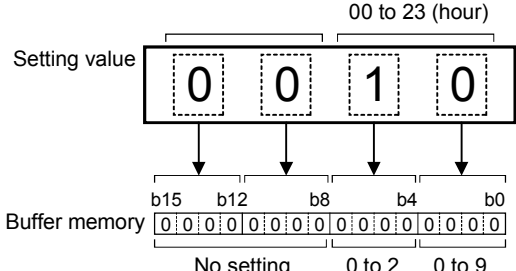
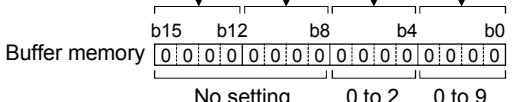
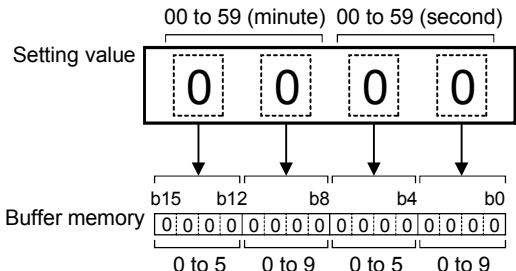
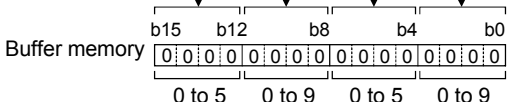
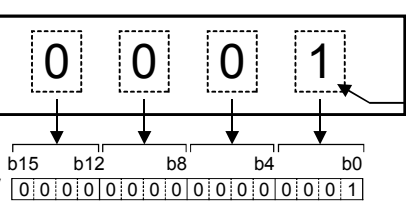
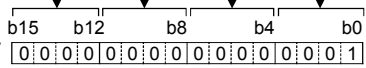
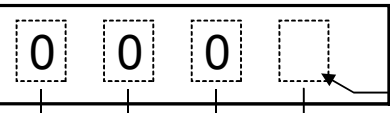
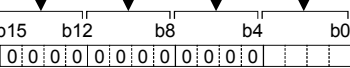
Setting value	Default value	Storage buffer memory address (common for axis 1 to axis 3)
<p>■ Set with a BCD code.</p> <p style="text-align: center;">00 to 23 (hour)</p> <p>Setting value </p> <p>Buffer memory </p>	0000	1100
<p>■ Set with a BCD code.</p> <p style="text-align: center;">00 to 59 (minute) 00 to 59 (second)</p> <p>Setting value </p> <p>Buffer memory </p>	0000	1101
<p>■ Set with a hexadecimal.</p> <p>Setting value </p> <p>Buffer memory </p> <p style="text-align: right;">● Clock data write 1: Clock data write request</p> <p style="text-align: center;">When the clock data is written, "0" is stored from the OS.</p>	0000H	1102
<p>■ Set with a hexadecimal.</p> <p>Setting value </p> <p>Buffer memory </p> <p style="text-align: right;">● Target axis 1: Axis 1 2: Axis 2 3: Axis 3 4: Axis 1 and axis 2 interpolation 5: Axis 2 and axis 3 interpolation 6: Axis 3 and axis 1 interpolation</p>	0000H	1103

Cd.

Setting item	Setting details
<p><input type="text" value="Cd.5"/> Positioning data No.</p>	<ul style="list-style-type: none"> • Set the positioning data No. targeted for reading or writing.
<p><input type="text" value="Cd.6"/> Write pattern</p>	<ul style="list-style-type: none"> • When writing the positioning data stored in the <input type="text" value="Cd.8"/> data storage address into the positioning data designated with <input type="text" value="Cd.5"/>, set the type of the data targeted for writing. <ul style="list-style-type: none"> * When reading, all data types are unconditionally read. ● Address field <p>Set how to write data into the positioning address and arc address of the positioning data.</p> ● Positioning data field <p>Set how to write the data other than the positioning address and arc address in the positioning data.</p>
<p><input type="text" value="Cd.7"/> Read/write request</p>	<ul style="list-style-type: none"> • When reading the positioning data, set "1". When writing, set "2". • Reading and writing are also carried out simultaneously for the interpolation axis. • Issue the write or read request when the PLC READY signal is OFF.

* to are data used to transmit the positioning data between the OS memory and buffer memory. (Refer to section "7.2 Data transmission process".)

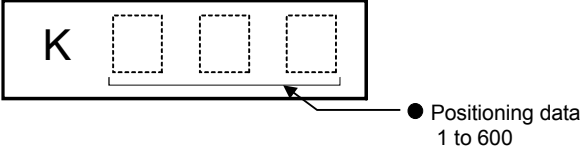
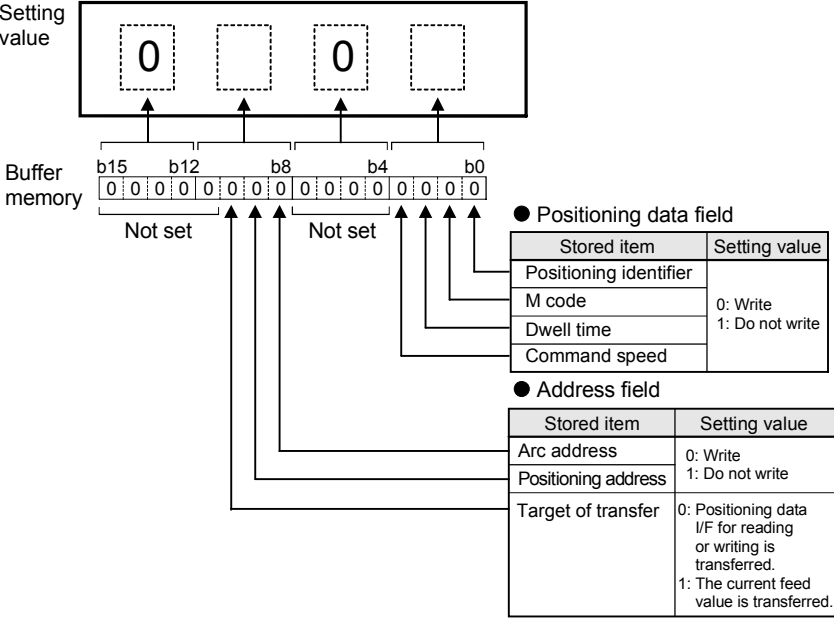
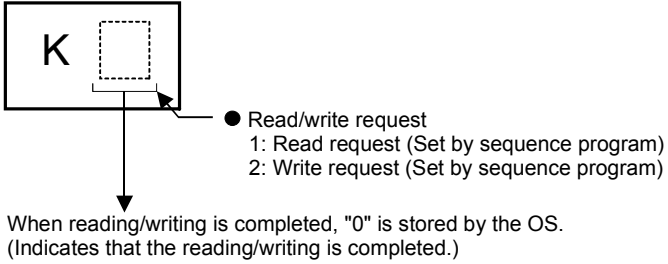
Setting value	Default value	Storage buffer memory address (common for axis 1 to axis 3)																		
<p>■ Set with a decimal.</p> <p>Setting value</p> 	0	1104																		
<p>■ Set with a hexadecimal.</p> <p>Setting value</p>  <p>Buffer memory</p> <p>● Positioning data field</p> <table border="1" data-bbox="695 1043 1015 1182"> <thead> <tr> <th>Stored item</th> <th>Setting value</th> </tr> </thead> <tbody> <tr> <td>Positioning identifier</td> <td></td> </tr> <tr> <td>M code</td> <td>0: Write 1: Do not write</td> </tr> <tr> <td>Dwell time</td> <td></td> </tr> <tr> <td>Command speed</td> <td></td> </tr> </tbody> </table> <p>● Address field</p> <table border="1" data-bbox="695 1218 1023 1429"> <thead> <tr> <th>Stored item</th> <th>Setting value</th> </tr> </thead> <tbody> <tr> <td>Arc address</td> <td>0: Write 1: Do not write</td> </tr> <tr> <td>Positioning address</td> <td></td> </tr> <tr> <td>Target of transfer</td> <td>0: Positioning data I/F for reading or writing is transferred. 1: The current feed value is transferred.</td> </tr> </tbody> </table>	Stored item	Setting value	Positioning identifier		M code	0: Write 1: Do not write	Dwell time		Command speed		Stored item	Setting value	Arc address	0: Write 1: Do not write	Positioning address		Target of transfer	0: Positioning data I/F for reading or writing is transferred. 1: The current feed value is transferred.	0000H	1105
Stored item	Setting value																			
Positioning identifier																				
M code	0: Write 1: Do not write																			
Dwell time																				
Command speed																				
Stored item	Setting value																			
Arc address	0: Write 1: Do not write																			
Positioning address																				
Target of transfer	0: Positioning data I/F for reading or writing is transferred. 1: The current feed value is transferred.																			
<p>■ Set with a decimal.</p> <p>Setting value</p>  <p>● Read/write request</p> <p>1: Read request (Set by sequence program) 2: Write request (Set by sequence program)</p> <p>When reading/writing is completed, "0" is stored by the OS. (Indicates that the reading/writing is completed.)</p>	0	1106																		

Setting item	Setting details			
<p><input type="checkbox"/> Cd.8 Read/write positioning data I/F</p>	<ul style="list-style-type: none"> • Store the data when reading or writing. 			
<p><input type="checkbox"/> Cd.9 Flash ROM write request</p>	<ul style="list-style-type: none"> • Write the OS memory contents into the flash ROM. 			
<p><input type="checkbox"/> Cd.10 Parameter initialization request</p>	<ul style="list-style-type: none"> • Set whether the setting data will be initialized or not. Initialization: Indicates that the setting values of the setting data are returned to the default values. Note) After completion of the setting data initialization processing, reset the PLC CPU or power on the PLC again. <p>Initialized setting data</p> <table border="1" data-bbox="587 1585 1102 1704"> <tr> <td>Parameter (<input type="checkbox"/> Pr.1 to <input type="checkbox"/> Pr.58)</td> </tr> <tr> <td>Positioning data (No. 1 to 600)</td> </tr> <tr> <td>Positioning start information (No. 7000 to 7010)</td> </tr> </table>	Parameter (<input type="checkbox"/> Pr.1 to <input type="checkbox"/> Pr.58)	Positioning data (No. 1 to 600)	Positioning start information (No. 7000 to 7010)
Parameter (<input type="checkbox"/> Pr.1 to <input type="checkbox"/> Pr.58)				
Positioning data (No. 1 to 600)				
Positioning start information (No. 7000 to 7010)				

* Cd.4 to Cd.8 are data used to transmit the positioning data between the OS memory and buffer memory. (Refer to section "7.2 Data transmission process".)

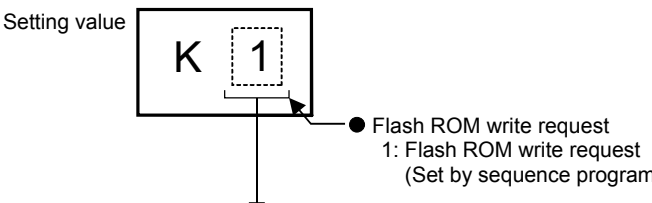
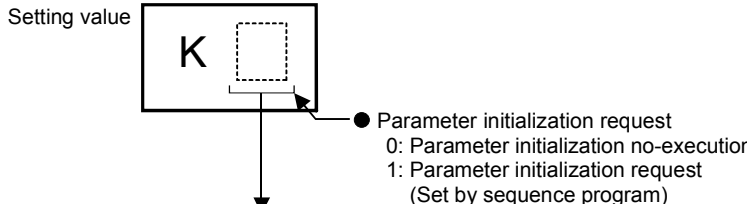
Setting value	Default value	Storage buffer memory address (common for axis 1 to axis 3)																																																				
<p>Each stored item is stored in the following storage address.</p> <table border="1" data-bbox="316 450 892 864"> <thead> <tr> <th colspan="3">Storage address</th> <th rowspan="2">Stored item</th> <th rowspan="2">Reference</th> </tr> <tr> <th>Axis 1</th> <th>Axis 2</th> <th>Axis 3</th> </tr> </thead> <tbody> <tr> <td>1108</td> <td>1118</td> <td>1128</td> <td>Positioning identifier</td> <td>Da.1 to Da.4</td> </tr> <tr> <td>1109</td> <td>1119</td> <td>1129</td> <td>M code</td> <td>Da.9</td> </tr> <tr> <td>1110</td> <td>1120</td> <td>1130</td> <td>Dwell time</td> <td>Da.8</td> </tr> <tr> <td>1111</td> <td>1121</td> <td>1131</td> <td>Not used</td> <td></td> </tr> <tr> <td>1112</td> <td>1122</td> <td>1132</td> <td rowspan="2">Command speed</td> <td rowspan="2">Da.7</td> </tr> <tr> <td>1113</td> <td>1123</td> <td>1133</td> </tr> <tr> <td>1114</td> <td>1124</td> <td>1134</td> <td rowspan="2">Positioning address</td> <td rowspan="2">Da.5</td> </tr> <tr> <td>1115</td> <td>1125</td> <td>1135</td> </tr> <tr> <td>1116</td> <td>1126</td> <td>1136</td> <td rowspan="2">Arc address</td> <td rowspan="2">Da.6</td> </tr> <tr> <td>1117</td> <td>1127</td> <td>1137</td> </tr> </tbody> </table>	Storage address			Stored item	Reference	Axis 1	Axis 2	Axis 3	1108	1118	1128	Positioning identifier	Da.1 to Da.4	1109	1119	1129	M code	Da.9	1110	1120	1130	Dwell time	Da.8	1111	1121	1131	Not used		1112	1122	1132	Command speed	Da.7	1113	1123	1133	1114	1124	1134	Positioning address	Da.5	1115	1125	1135	1116	1126	1136	Arc address	Da.6	1117	1127	1137	0	1108 to 1137
Storage address			Stored item			Reference																																																
Axis 1	Axis 2	Axis 3																																																				
1108	1118	1128	Positioning identifier	Da.1 to Da.4																																																		
1109	1119	1129	M code	Da.9																																																		
1110	1120	1130	Dwell time	Da.8																																																		
1111	1121	1131	Not used																																																			
1112	1122	1132	Command speed	Da.7																																																		
1113	1123	1133																																																				
1114	1124	1134	Positioning address	Da.5																																																		
1115	1125	1135																																																				
1116	1126	1136	Arc address	Da.6																																																		
1117	1127	1137																																																				
<p>■ Set with a decimal.</p> <p>Setting value</p>  <p>● Flash ROM write request 1: Flash ROM write request (Set by sequence program)</p> <p>After writing is completed, "0" is stored by the OS. (Indicates that the writing is completed.)</p>	0	1138																																																				
<p>■ Set with a decimal.</p> <p>Setting value</p>  <p>● Parameter initialization request 0: Parameter initialization no-execution 1: Parameter initialization request (Set by sequence program)</p> <p>After initialization, "0" is stored by the OS. (Indicates that the writing is completed.)</p>	0	1139																																																				

5.7.2 Axis control data

Setting item	Setting details
<p>[Cd.11] Positioning start No.</p>	<ul style="list-style-type: none"> • Set the positioning start No.
<p>[Cd.12] Axis error reset</p>	<ul style="list-style-type: none"> • Clears the axis error detection, axis error No., axis warning detection and axis warning No. • When the AD75 axis operation state is "in error occurrence", the error is cleared and the AD75 is returned to the "waiting" state.
<p>[Cd.13] Restart command</p>	<ul style="list-style-type: none"> • When positioning is stopped for any reason (when axis operation state is "stopped"), set "1" in [Cd.13]. Positioning will be carried out again from the stopped position to the end point of the stopped positioning data.
<p>[Cd.14] M code OFF request</p>	<ul style="list-style-type: none"> • The M code ON signal turns OFF.

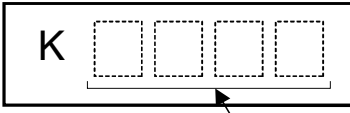
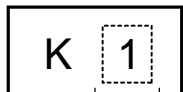
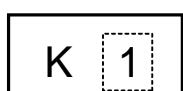
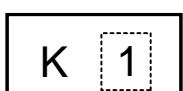
Setting value	Default value	Storage buffer memory address		
		Axis 1	Axis 2	Axis 3
<p>■ Set with a decimal.</p> <p>Setting value</p>  <ul style="list-style-type: none"> ● Positioning data No. - 1 to 600 : Positioning data No. - 7000 to 7010 : Block start designation - 8001 to 8050 : Indirectly specification - 9001 : Machine zero point return - 9002 : High-speed zero point return - 9003 : Current value change 	0	1150	1200	1250
<p>■ Set with a decimal.</p> <p>Setting value</p>  <ul style="list-style-type: none"> ● Error reset request Axis 1: Axis error is reset. (Set by sequence program) <p>After the axis error reset is completed, "0" is stored by the OS. (Indicates that the axis error reset is completed.)</p>	0	1151	1201	1251
<p>■ Set with a decimal.</p> <p>Setting value</p>  <ul style="list-style-type: none"> ● Restart command 1: Restarts (Set by sequence program) <p>After restart acceptance is completed, "0" is stored by the OS. (Indicates that the restart acceptance is completed.)</p>	0	1152	1202	1252
<p>■ Set with a decimal.</p> <p>Setting value</p>  <ul style="list-style-type: none"> ● M code OFF request 1: M code ON signal turns OFF (Set by sequence program) <p>After the M code ON signal turns OFF, "0" is stored by the OS. (Indicates that the OFF request is completed.)</p>	0	1153	1203	1253



Setting item	Setting details																	
<p>[Cd.15] New current value</p>	<ul style="list-style-type: none"> When changing the current feed value using the start No. "9003", set the new current feed value. The value is set within the following range. <table border="1" data-bbox="584 483 1407 748"> <thead> <tr> <th data-bbox="584 483 751 562"> <table border="1"> <tr> <td data-bbox="584 483 751 517">Pr.11</td> <td data-bbox="751 483 911 517">Pr.1</td> </tr> </table> </th> <th data-bbox="751 483 911 562">mm ($\times 10^{-1}\mu\text{m}$)</th> <th data-bbox="911 483 1070 562">inch ($\times 10^{-5}\text{inch}$)</th> <th data-bbox="1070 483 1230 562">degree ($\times 10^{-5}\text{degree}$)</th> <th data-bbox="1230 483 1407 562">pulse (pulse)</th> </tr> </thead> <tbody> <tr> <td data-bbox="584 562 751 651">Standard mode</td> <td data-bbox="751 562 911 651">-2147483648 to +2147483647</td> <td data-bbox="911 562 1070 651">-2147483648 to +2147483647</td> <td data-bbox="1070 562 1230 651">0 to 35999999</td> <td data-bbox="1230 562 1407 651">-2147483648 to +2147483647</td> </tr> <tr> <td data-bbox="584 651 751 748">Stepping motor mode</td> <td data-bbox="751 651 911 748">-134217728 to +134217727</td> <td data-bbox="911 651 1070 748">-134217728 to +134217727</td> <td data-bbox="1070 651 1230 748">0 to 35999999</td> <td data-bbox="1230 651 1407 748">-134217728 to +134217727</td> </tr> </tbody> </table>	<table border="1"> <tr> <td data-bbox="584 483 751 517">Pr.11</td> <td data-bbox="751 483 911 517">Pr.1</td> </tr> </table>	Pr.11	Pr.1	mm ($\times 10^{-1}\mu\text{m}$)	inch ($\times 10^{-5}\text{inch}$)	degree ($\times 10^{-5}\text{degree}$)	pulse (pulse)	Standard mode	-2147483648 to +2147483647	-2147483648 to +2147483647	0 to 35999999	-2147483648 to +2147483647	Stepping motor mode	-134217728 to +134217727	-134217728 to +134217727	0 to 35999999	-134217728 to +134217727
<table border="1"> <tr> <td data-bbox="584 483 751 517">Pr.11</td> <td data-bbox="751 483 911 517">Pr.1</td> </tr> </table>	Pr.11	Pr.1	mm ($\times 10^{-1}\mu\text{m}$)	inch ($\times 10^{-5}\text{inch}$)	degree ($\times 10^{-5}\text{degree}$)	pulse (pulse)												
Pr.11	Pr.1																	
Standard mode	-2147483648 to +2147483647	-2147483648 to +2147483647	0 to 35999999	-2147483648 to +2147483647														
Stepping motor mode	-134217728 to +134217727	-134217728 to +134217727	0 to 35999999	-134217728 to +134217727														
<p>[Cd.16] New speed value</p>	<ul style="list-style-type: none"> When changing the speed, set the new speed. The operation will stop when "0" is set. The value is set within the following range. <table border="1" data-bbox="584 909 1407 1146"> <thead> <tr> <th data-bbox="584 909 751 1010"> <table border="1"> <tr> <td data-bbox="584 909 751 943">Pr.11</td> <td data-bbox="751 909 911 943">Pr.1</td> </tr> </table> </th> <th data-bbox="751 909 911 1010">mm ($\times 10^{-2}\text{mm/min}$)</th> <th data-bbox="911 909 1070 1010">inch ($\times 10^{-3}\text{inch/min}$)</th> <th data-bbox="1070 909 1230 1010">degree ($\times 10^{-3}\text{degree/min}$)</th> <th data-bbox="1230 909 1407 1010">pulse (pulse/s)</th> </tr> </thead> <tbody> <tr> <td data-bbox="584 1010 751 1077">Standard mode</td> <td data-bbox="751 1010 911 1077">0 to 600000000</td> <td data-bbox="911 1010 1070 1077">0 to 600000000</td> <td data-bbox="1070 1010 1230 1077">0 to 600000000</td> <td data-bbox="1230 1010 1407 1077">0 to 1000000</td> </tr> <tr> <td data-bbox="584 1077 751 1146">Stepping motor mode</td> <td data-bbox="751 1077 911 1146">0 to 37500000</td> <td data-bbox="911 1077 1070 1146">0 to 37500000</td> <td data-bbox="1070 1077 1230 1146">0 to 37500000</td> <td data-bbox="1230 1077 1407 1146">0 to 62500</td> </tr> </tbody> </table>	<table border="1"> <tr> <td data-bbox="584 909 751 943">Pr.11</td> <td data-bbox="751 909 911 943">Pr.1</td> </tr> </table>	Pr.11	Pr.1	mm ($\times 10^{-2}\text{mm/min}$)	inch ($\times 10^{-3}\text{inch/min}$)	degree ($\times 10^{-3}\text{degree/min}$)	pulse (pulse/s)	Standard mode	0 to 600000000	0 to 600000000	0 to 600000000	0 to 1000000	Stepping motor mode	0 to 37500000	0 to 37500000	0 to 37500000	0 to 62500
<table border="1"> <tr> <td data-bbox="584 909 751 943">Pr.11</td> <td data-bbox="751 909 911 943">Pr.1</td> </tr> </table>	Pr.11	Pr.1	mm ($\times 10^{-2}\text{mm/min}$)	inch ($\times 10^{-3}\text{inch/min}$)	degree ($\times 10^{-3}\text{degree/min}$)	pulse (pulse/s)												
Pr.11	Pr.1																	
Standard mode	0 to 600000000	0 to 600000000	0 to 600000000	0 to 1000000														
Stepping motor mode	0 to 37500000	0 to 37500000	0 to 37500000	0 to 62500														
<p>[Cd.17] Speed change request</p>	<p>To request the speed change process (to validate the [Cd.16] value) after setting the "[Cd.16] New speed value", set "1".</p>																	
<p>[Cd.18] Positioning operation speed override</p>	<ul style="list-style-type: none"> When applying an override on the speed during positioning operation, set the "override" value. <p>* Refer to section "12.5.2 Override function" for details on the "override".</p>																	

Setting value	Default value	Storage buffer memory address																						
		Axis 1	Axis 2	Axis 3																				
<p>■ Set with a decimal.</p> <p>Actual value</p> <div style="border: 1px solid black; padding: 5px; display: inline-block;"> Cd.15 New current value Cd.16 New speed value </div> <p style="margin-left: 40px;">↓</p> <p>◇ Integer value $\times 10^n$ → ● Unit conversion table (Cd.15)</p> <table border="1" style="margin-left: 100px;"> <thead> <tr><th>n</th><th>Unit</th></tr> </thead> <tbody> <tr><td>1</td><td>mm</td></tr> <tr><td>5</td><td>inch</td></tr> <tr><td>5</td><td>degree</td></tr> <tr><td>0</td><td>pulse</td></tr> </tbody> </table> <p>● Unit conversion table (Cd.16)</p> <table border="1" style="margin-left: 100px;"> <thead> <tr><th>n</th><th>Unit</th></tr> </thead> <tbody> <tr><td>2</td><td>mm/min</td></tr> <tr><td>3</td><td>inch/min</td></tr> <tr><td>3</td><td>degree/min</td></tr> <tr><td>0</td><td>pulse/s</td></tr> </tbody> </table> <p>Setting value (decimal) R</p> <div style="border: 1px dashed black; padding: 5px; margin-top: 10px;"> <p>Example)</p> <p>When setting "10000.00mm/min" in the "Cd.16 New speed value", set "1000000" in the buffer memory.</p> </div>	n	Unit	1	mm	5	inch	5	degree	0	pulse	n	Unit	2	mm/min	3	inch/min	3	degree/min	0	pulse/s	0	1154 1155	1204 1205	1254 1255
n	Unit																							
1	mm																							
5	inch																							
5	degree																							
0	pulse																							
n	Unit																							
2	mm/min																							
3	inch/min																							
3	degree/min																							
0	pulse/s																							
<p>■ Set with a decimal.</p> <p>Setting value K 1</p> <p style="margin-left: 40px;">● Cd.17 Speed change request 1: Change speed (Set by sequence program)</p> <p style="margin-left: 40px;">↓</p> <p>After accepting the speed change, "0" is stored by the OS. (Indicates that the speed change acceptance is completed.)</p>	0	1158	1208	1258																				
<p>■ Set with a decimal.</p> <p>Setting value K □ □ □</p> <p style="margin-left: 40px;">● Override value (%) 1 to 300</p>	0	1159	1209	1259																				

Setting item	Setting details																									
<p>Cd.19 JOG speed</p>	<ul style="list-style-type: none"> • Set the JOG speed for JOG operation. • The value is set within the following range. <table border="1" data-bbox="584 564 1407 797"> <thead> <tr> <th data-bbox="584 564 751 667"> <table border="1"> <tr> <td data-bbox="584 564 751 618">Pr.1</td> <td data-bbox="751 564 919 667">mm ($\times 10^{-2}$mm/min)</td> <td data-bbox="919 564 1086 667">inch ($\times 10^{-3}$ inch/min)</td> <td data-bbox="1086 564 1254 667">degree ($\times 10^{-3}$ degree/min)</td> <td data-bbox="1254 564 1407 667">pulse (pulse/s)</td> </tr> <tr> <td data-bbox="584 618 751 667">Pr.11</td> <td></td> <td></td> <td></td> <td></td> </tr> </table> </th> <th data-bbox="751 564 919 667"></th> <th data-bbox="919 564 1086 667"></th> <th data-bbox="1086 564 1254 667"></th> <th data-bbox="1254 564 1407 667"></th> </tr> </thead> <tbody> <tr> <td data-bbox="584 667 751 734">Standard mode</td> <td data-bbox="751 667 919 734">0 to 600000000</td> <td data-bbox="919 667 1086 734">0 to 600000000</td> <td data-bbox="1086 667 1254 734">0 to 600000000</td> <td data-bbox="1254 667 1407 734">0 to 1000000</td> </tr> <tr> <td data-bbox="584 734 751 797">Stepping motor mode</td> <td data-bbox="751 734 919 797">0 to 37500000</td> <td data-bbox="919 734 1086 797">0 to 37500000</td> <td data-bbox="1086 734 1254 797">0 to 37500000</td> <td data-bbox="1254 734 1407 797">0 to 62500</td> </tr> </tbody> </table>	<table border="1"> <tr> <td data-bbox="584 564 751 618">Pr.1</td> <td data-bbox="751 564 919 667">mm ($\times 10^{-2}$mm/min)</td> <td data-bbox="919 564 1086 667">inch ($\times 10^{-3}$ inch/min)</td> <td data-bbox="1086 564 1254 667">degree ($\times 10^{-3}$ degree/min)</td> <td data-bbox="1254 564 1407 667">pulse (pulse/s)</td> </tr> <tr> <td data-bbox="584 618 751 667">Pr.11</td> <td></td> <td></td> <td></td> <td></td> </tr> </table>	Pr.1	mm ($\times 10^{-2}$ mm/min)	inch ($\times 10^{-3}$ inch/min)	degree ($\times 10^{-3}$ degree/min)	pulse (pulse/s)	Pr.11									Standard mode	0 to 600000000	0 to 600000000	0 to 600000000	0 to 1000000	Stepping motor mode	0 to 37500000	0 to 37500000	0 to 37500000	0 to 62500
<table border="1"> <tr> <td data-bbox="584 564 751 618">Pr.1</td> <td data-bbox="751 564 919 667">mm ($\times 10^{-2}$mm/min)</td> <td data-bbox="919 564 1086 667">inch ($\times 10^{-3}$ inch/min)</td> <td data-bbox="1086 564 1254 667">degree ($\times 10^{-3}$ degree/min)</td> <td data-bbox="1254 564 1407 667">pulse (pulse/s)</td> </tr> <tr> <td data-bbox="584 618 751 667">Pr.11</td> <td></td> <td></td> <td></td> <td></td> </tr> </table>	Pr.1	mm ($\times 10^{-2}$ mm/min)	inch ($\times 10^{-3}$ inch/min)	degree ($\times 10^{-3}$ degree/min)	pulse (pulse/s)	Pr.11																				
Pr.1	mm ($\times 10^{-2}$ mm/min)	inch ($\times 10^{-3}$ inch/min)	degree ($\times 10^{-3}$ degree/min)	pulse (pulse/s)																						
Pr.11																										
Standard mode	0 to 600000000	0 to 600000000	0 to 600000000	0 to 1000000																						
Stepping motor mode	0 to 37500000	0 to 37500000	0 to 37500000	0 to 62500																						
<p>Cd.20 Speed/position changeover enable flag</p>	<ul style="list-style-type: none"> • Set whether to validate the control signal (speed/position changeover signal) from an external source. 																									
<p>Cd.21 Speed/position changeover control movement amount change register</p>	<ul style="list-style-type: none"> • To change the movement amount for the position control during speed control of speed/position changeover control, set the movement amount after changing to position control. • Make the setting during the speed control of speed/positioning changeover control. • The setting value is cleared to 0 at the next start. • Set the value within the following range. <table border="1" data-bbox="584 1592 1407 1803"> <thead> <tr> <th data-bbox="584 1592 751 1666"> <table border="1"> <tr> <td data-bbox="584 1592 751 1637">Pr.1</td> <td data-bbox="751 1592 919 1666">mm ($\times 10^{-1}$$\mu$mm)</td> <td data-bbox="919 1592 1086 1666">inch ($\times 10^{-5}$inch)</td> <td data-bbox="1086 1592 1254 1666">degree ($\times 10^{-5}$degree)</td> <td data-bbox="1254 1592 1407 1666">pulse (pulse)</td> </tr> <tr> <td data-bbox="584 1637 751 1666">Pr.11</td> <td></td> <td></td> <td></td> <td></td> </tr> </table> </th> <th data-bbox="751 1592 919 1666"></th> <th data-bbox="919 1592 1086 1666"></th> <th data-bbox="1086 1592 1254 1666"></th> <th data-bbox="1254 1592 1407 1666"></th> </tr> </thead> <tbody> <tr> <td data-bbox="584 1666 751 1733">Standard mode</td> <td data-bbox="751 1666 919 1733">0 to 2147483647</td> <td data-bbox="919 1666 1086 1733">0 to 2147483647</td> <td data-bbox="1086 1666 1254 1733">0 to 2147483647</td> <td data-bbox="1254 1666 1407 1733">0 to 2147483647</td> </tr> <tr> <td data-bbox="584 1733 751 1803">Stepping motor mode</td> <td data-bbox="751 1733 919 1803">0 to 134217727</td> <td data-bbox="919 1733 1086 1803">0 to 134217727</td> <td data-bbox="1086 1733 1254 1803">0 to 134217727</td> <td data-bbox="1254 1733 1407 1803">0 to 134217727</td> </tr> </tbody> </table>	<table border="1"> <tr> <td data-bbox="584 1592 751 1637">Pr.1</td> <td data-bbox="751 1592 919 1666">mm ($\times 10^{-1}$$\mu$mm)</td> <td data-bbox="919 1592 1086 1666">inch ($\times 10^{-5}$inch)</td> <td data-bbox="1086 1592 1254 1666">degree ($\times 10^{-5}$degree)</td> <td data-bbox="1254 1592 1407 1666">pulse (pulse)</td> </tr> <tr> <td data-bbox="584 1637 751 1666">Pr.11</td> <td></td> <td></td> <td></td> <td></td> </tr> </table>	Pr.1	mm ($\times 10^{-1}$ μ mm)	inch ($\times 10^{-5}$ inch)	degree ($\times 10^{-5}$ degree)	pulse (pulse)	Pr.11									Standard mode	0 to 2147483647	0 to 2147483647	0 to 2147483647	0 to 2147483647	Stepping motor mode	0 to 134217727	0 to 134217727	0 to 134217727	0 to 134217727
<table border="1"> <tr> <td data-bbox="584 1592 751 1637">Pr.1</td> <td data-bbox="751 1592 919 1666">mm ($\times 10^{-1}$$\mu$mm)</td> <td data-bbox="919 1592 1086 1666">inch ($\times 10^{-5}$inch)</td> <td data-bbox="1086 1592 1254 1666">degree ($\times 10^{-5}$degree)</td> <td data-bbox="1254 1592 1407 1666">pulse (pulse)</td> </tr> <tr> <td data-bbox="584 1637 751 1666">Pr.11</td> <td></td> <td></td> <td></td> <td></td> </tr> </table>	Pr.1	mm ($\times 10^{-1}$ μ mm)	inch ($\times 10^{-5}$ inch)	degree ($\times 10^{-5}$ degree)	pulse (pulse)	Pr.11																				
Pr.1	mm ($\times 10^{-1}$ μ mm)	inch ($\times 10^{-5}$ inch)	degree ($\times 10^{-5}$ degree)	pulse (pulse)																						
Pr.11																										
Standard mode	0 to 2147483647	0 to 2147483647	0 to 2147483647	0 to 2147483647																						
Stepping motor mode	0 to 134217727	0 to 134217727	0 to 134217727	0 to 134217727																						

Setting value	Default value	Storage buffer memory address												
		Axis 1	Axis 2	Axis 3										
<p>■ Set with a decimal.</p> <p>Actual value Cd.19 JOG speed</p> <p style="text-align: center;">◇ Integer value × 10ⁿ</p> <p>Setting value (decimal) R</p> <p style="text-align: right;">● Unit conversion table (Cd.19)</p> <table border="1" style="margin-left: auto;"> <thead> <tr> <th>n</th> <th>Unit</th> </tr> </thead> <tbody> <tr> <td>2</td> <td>mm/min</td> </tr> <tr> <td>3</td> <td>inch/min</td> </tr> <tr> <td>3</td> <td>degree/min</td> </tr> <tr> <td>0</td> <td>pulse/s</td> </tr> </tbody> </table> <div style="border: 1px dashed black; padding: 5px; margin-top: 10px;"> <p>Example)</p> <p>When setting "20000.00mm/min" in the "Cd.19 JOG speed", set "2000000" in the buffer memory.</p> </div>	n	Unit	2	mm/min	3	inch/min	3	degree/min	0	pulse/s	0	1160 1161	1210 1211	1260 1261
n	Unit													
2	mm/min													
3	inch/min													
3	degree/min													
0	pulse/s													
<p>■ Set with a decimal.</p> <p>Setting value K </p> <p style="text-align: right;">● Cd.20 Speed/position changeover enable flag</p> <p>0: Even if the speed/position changeover signal turns ON, the control does not change from speed to position control.</p> <p>1: When the speed/position changeover signal turns ON, the control changes from speed to position control.</p>	0	1163	1213	1263										
<p>■ Set with a decimal.</p> <p>Actual value Cd.21 Speed/position changeover control movement amount change register</p> <p style="text-align: center;">◇ Integer value × 10ⁿ</p> <p>Setting value (decimal) R</p> <p style="text-align: right;">● Unit conversion table (Cd.21)</p> <table border="1" style="margin-left: auto;"> <thead> <tr> <th>n</th> <th>Unit</th> </tr> </thead> <tbody> <tr> <td>1</td> <td>mm</td> </tr> <tr> <td>5</td> <td>inch</td> </tr> <tr> <td>5</td> <td>degree</td> </tr> <tr> <td>0</td> <td>pulse</td> </tr> </tbody> </table> <div style="border: 1px dashed black; padding: 5px; margin-top: 10px;"> <p>Example)</p> <p>When setting "20000.0mm" in the "Cd.21 Speed/position changeover control movement amount change register", set "200000" in the buffer memory.</p> </div>	n	Unit	1	mm	5	inch	5	degree	0	pulse	0	1164 1165	1214 1215	1264 1265
n	Unit													
1	mm													
5	inch													
5	degree													
0	pulse													

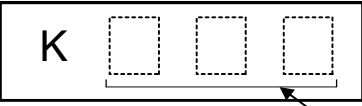

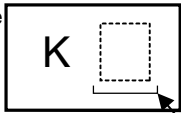
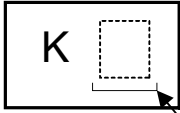
Setting item	Setting details	
<p>[Cd.22] Manual pulse generator enable flag</p>	<ul style="list-style-type: none"> • Set whether or not to carry out manual pulse generator operation. 	
<p>[Cd.23] Manual pulse generator 1 pulse input magnification</p>	<ul style="list-style-type: none"> • Set the magnification of the No. of pulses input from the manual pulse generator. • When setting value is 0 or less: Processed as "1" • When setting value is 101 or more: Processed as "100" 	
<p>[Cd.24] Zero point return request flag OFF request</p>	<ul style="list-style-type: none"> • When the zero point return request flag is ON, set the request to turn this OFF forcibly with the sequence program. 	
<p>[Cd.25] External start valid</p>	<ul style="list-style-type: none"> • Set whether external starting is valid. 	
<p>[Cd.26] Step valid flag</p>	<ul style="list-style-type: none"> • Set whether to carry out step operation. 	

Setting value	Default value	Storage buffer memory address		
		Axis 1	Axis 2	Axis 3
<p>■ Set with a decimal.</p> <p>Setting value </p> <p>● Manual pulse generator enable flag 0: Disable manual pulse generator operation 1: Enable manual pulse generator operation</p>	0	1167	1217	1267
<p>■ Set with a decimal.</p> <p>Setting value </p> <p>● Manual pulse generator 1 pulse input magnification 1 to 100</p>	1	1168 1169	1218 1219	1268 1269
<p>■ Set with a decimal.</p> <p>Setting value </p> <p>● Zero point return request flag OFF request 1: Turn OFF the "zero point return request flag" that is ON. (Set by sequence program)</p> <p>After the zero point return request turns OFF, "0" is stored by the OS. (Indicates that the zero point return request flag OFF request is completed.)</p>	0	1170	1220	1270
<p>■ Set with a decimal.</p> <p>Setting value </p> <p>● External start valid 0: Invalidate external start 1: Validate external start</p>	0	1171	1221	1271
<p>■ Set with a decimal.</p> <p>Setting value </p> <p>● Step valid flag 0: Do not carry out step operation 1: Carry out step operation</p>	0	1172	1222	1272

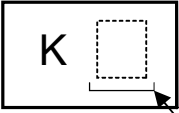
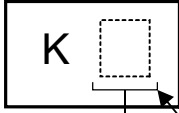
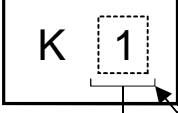
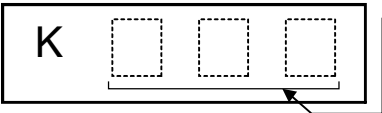
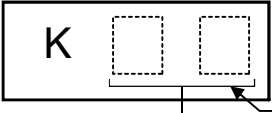
Setting item	Setting details	
[Cd.27] Step mode	<ul style="list-style-type: none"> • When using step operation, set which unit to step with. 	
[Cd.28] Step start information	<ul style="list-style-type: none"> • When using step operation, set whether to continue or restart operation. 	
[Cd.29] Skip command	<ul style="list-style-type: none"> • Set "1" to skip the current positioning. 	
[Cd.30] New torque value	<ul style="list-style-type: none"> • To change the "[Md.45] Torque limit stored value", set the new estimated torque limit stored value. • Set the value within the "[Pr.18] Torque limit setting value" range. 	
[Cd.31] Positioning starting point No.	<ul style="list-style-type: none"> • Set the "start point No. (1 to 50)" for executing block start (positioning). (If setting the value other than 1 to 50, process it as "1".) 	

Setting value	Default value	Storage buffer memory address		
		Axis 1	Axis 2	Axis 3
<p>■ Set with a decimal.</p> <p>Setting value</p>  <p>● Step mode 0: Carry out step operation with deceleration unit 1: Carry out step operation with data No. unit</p>	0	1173	1223	1273
<p>■ Set with a decimal.</p> <p>Setting value</p>  <p>● Step start information 1: Step continue 2: Restart</p> <p>After the step start request is accepted, "0" is stored by the OS.</p>	0	1174	1224	1274
<p>■ Set with a decimal.</p> <p>Setting value</p>  <p>● Skip command 1: Decelerate to a stop, and then carry out the next positioning. (Skip request) (Set by sequence program)</p> <p>After the skip request is accepted, "0" is stored by the OS.</p>	0	1175	1225	1275
<p>■ Set with a decimal.</p> <p>Setting value</p>  <p>● New torque value 1 to [Pr.18] Torque limit setting value</p>	0	1176	1226	1276
<p>■ Set with a decimal.</p> <p>Setting value</p>  <p>● Positioning starting point No. 1 to 50</p> <p>When continuous operation is interrupted, "0" is stored automatically.</p>	0	1178	1228	1278

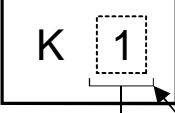
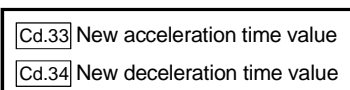
Setting item	Setting details						
<p>Cd.32 Interrupt request during continuous operation</p>	<ul style="list-style-type: none"> • To interrupt the operation during continuous operation, set "1". • If the interrupt request is received after setting "1", "0" will be automatically stored by the OS. 						
<p>Cd.33 New acceleration time value</p>	<ul style="list-style-type: none"> • When changing the acceleration time during speed change, set the new acceleration time. <table border="1" data-bbox="596 882 1251 1025"> <thead> <tr> <th data-bbox="596 882 874 949">Pr.25 setting</th> <th data-bbox="874 882 1251 949">Cd.33 setting range (unit)</th> </tr> </thead> <tbody> <tr> <td data-bbox="596 949 874 987">1-word type</td> <td data-bbox="874 949 1251 987">0 to 65535 (mm)</td> </tr> <tr> <td data-bbox="596 987 874 1025">2-word type</td> <td data-bbox="874 987 1251 1025">0 to 8388608 (ms)</td> </tr> </tbody> </table>	Pr.25 setting	Cd.33 setting range (unit)	1-word type	0 to 65535 (mm)	2-word type	0 to 8388608 (ms)
Pr.25 setting	Cd.33 setting range (unit)						
1-word type	0 to 65535 (mm)						
2-word type	0 to 8388608 (ms)						
<p>Cd.34 New deceleration time value</p>	<ul style="list-style-type: none"> • When changing the deceleration time during speed change, set the new deceleration time. <table border="1" data-bbox="596 1225 1251 1368"> <thead> <tr> <th data-bbox="596 1225 874 1292">Pr.25 setting</th> <th data-bbox="874 1225 1251 1292">Cd.33 setting range (unit)</th> </tr> </thead> <tbody> <tr> <td data-bbox="596 1292 874 1330">1-word type</td> <td data-bbox="874 1292 1251 1330">0 to 65535 (mm)</td> </tr> <tr> <td data-bbox="596 1330 874 1368">2-word type</td> <td data-bbox="874 1330 1251 1368">0 to 8388608 (ms)</td> </tr> </tbody> </table>	Pr.25 setting	Cd.33 setting range (unit)	1-word type	0 to 65535 (mm)	2-word type	0 to 8388608 (ms)
Pr.25 setting	Cd.33 setting range (unit)						
1-word type	0 to 65535 (mm)						
2-word type	0 to 8388608 (ms)						
<p>Cd.35 Acceleration/deceleration time change during speed change, enable/disable selection</p>	<ul style="list-style-type: none"> • Set whether to enable/disable the acceleration/deceleration time change during speed change. 						

Setting value	Default value	Storage buffer memory address		
		Axis 1	Axis 2	Axis 3
<p>■ Set with a decimal.</p> <p>Setting value </p> <p>● Continuous operation interrupt request 1: Interrupt continuous control or continuous path control. (Set by sequence program)</p> <p>After the control interrupt request is accepted, "0" is stored by the OS. (Indicates that the continuous operation interrupt request is completed.)</p>	0	1181	1231	1281
<p>■ Set with a decimal.</p> <p>Setting value </p> <p>Example)</p> <p>To set "60000ms" for the "Cd.33 New acceleration time value", set "60000" in the buffer memory.</p>	0	1184 1185	1234 1235	1284 1285
<p>■ Set with a decimal.</p> <p>Setting value </p> <p>● Acceleration/deceleration time change during speed change, enable/disable selection</p> <p>1: Enable acceleration/deceleration time change Other than 1: Disable acceleration/deceleration time change</p>	0	1186 1187	1236 1237	1286 1287
<p>■ Set with a decimal.</p> <p>Setting value </p> <p>● Acceleration/deceleration time change during speed change, enable/disable selection</p> <p>1: Enable acceleration/deceleration time change Other than 1: Disable acceleration/deceleration time change</p>	0	1188	1238	1288

MEMO

Chapter 6

SEQUENCE PROGRAM USED FOR POSITIONING CONTROL

The programs required to carry out positioning control with the AD75 are explained in this chapter.

The sequence program required for control is created allowing for the "start conditions", "start time chart", "device settings" and general control configuration. (The parameters, positioning data, start block data and condition data, etc., must be set in the AD75 according to the control to be executed, and program for setting the control data or a program for starting the various control must be created.)

The first half of this chapter explains the program configuration of general control, and the latter half explains the program details. Create the required program while referring to the various control details explained in "SECTION 2", and to "Chapter 5 DATA USED FOR POSITIONING CONTROL".

6.1	Precautions for creating program	6- 2
6.2	List of devices used	6- 4
6.3	Creating a program	6- 8
6.3.1	General configuration of program	6- 8
6.3.2	Positioning control operation program	6- 9
6.4	Positioning program examples.....	6- 12
6.5	Program details	6- 21
6.5.1	Initialization program.....	6- 21
6.5.2	Start details setting program.....	6- 22
6.5.3	Start program	6- 23
6.5.4	Continuous operation interrupt program	6- 31
6.5.5	Restart program	6- 33
6.5.6	Stop program	6- 36

6.1 Precautions for creating program

The common precautions to be taken when writing data from the PLC CPU to the AD75 buffer memory are described below.

When diverting any of the program examples introduced in this manual to the actual system, fully verify that there are no problems in the controllability of the target system.

(1) Reading/writing the data

Setting the data explained in this chapter (various parameters, positioning data, positioning start information) should be set using the AD75 software package. When set with the sequence program, many sequence programs and devices must be used. This will not only complicate the program, but will also increase the scan time.

When rewriting the positioning data during continuous path control or continuous positioning control, rewrite the data four positioning data items before the actual execution. If the positioning data is not rewritten before the positioning data four items earlier is executed, the process will be carried out as if the data was not rewritten.

(2) Programming with the A0J2CPU

When using the AD75 with the A0J2CPU, there are commands that cannot be used, such as TOP/FROMP.

Change these as shown below.

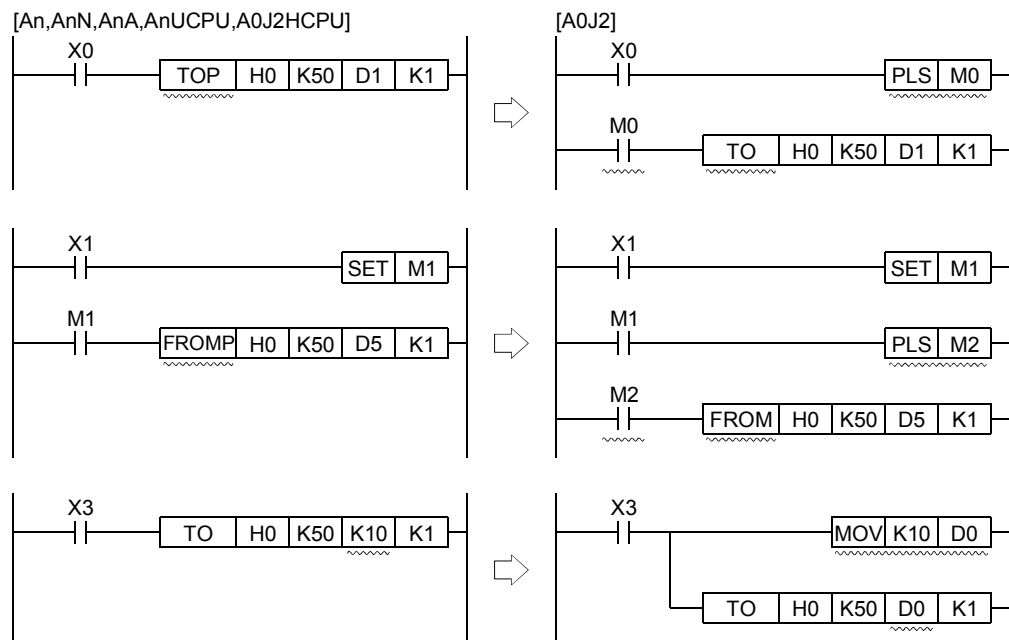

(3) Restrictions to No. of FROM/TO commands executed in one scan

The FROM/TO command (during 16-bit data transmission) and DFRO/DTO command (during 32-bit data transmission) that can be executed with one PLC CPU scan using the AD75 are as follow.

- (a) With the 1-axis and 2-axis module, the FROM/TO command and DFRO/DTO command can be executed up to ten times per axis.

- (b) With the 3-axis module, the No. of FROM/TO command and DFRO/DTO command executions differs according to the function to be executed.
- When carrying out circular interpolation control and S-curve acceleration/deceleration : 4 times/axis
 - When CHG input is input simultaneously for two axes during speed/position changeover control : 4 times/axis
 - When not carrying out the above control : 10 times/axis

	Circular interpolation control	S-curve acceleration/deceleration	Speed/position changeover control (CHG input simultaneously for two axes)	Control other than that on left
A1SD75P1-S3 AD75P1-S3	10 times/axis	10 times/axis	10 times/axis	10 times/axis
A1SD75P2-S3 AD75P2-S3	10 times/axis	10 times/axis	10 times/axis	10 times/axis
A1SD75P3-S3 AD75P3-S3	4 times/axis	4 times/axis	4 times/axis	10 times/axis

(4) Restrictions to speed change execution interval

Provide an interval of 100ms or more when changing the speed with the AD75.

(5) Process during overrun

Overrun is prevented with the AD75's upper and lower stroke limit. However, this applies only when the AD75 is operating correctly. In terms of the entire system's safety, it is recommended to provide a boundary limit switch and provide an external circuit that will power OFF the motor when the limit switch operates.

(6) AD75 mounting position

Unless particularly designated following this chapter, the sequence program for the following conditions is shown.

- PLC CPU module : A3UCPU
- AD75 input/output signal : X/Y00H to X/Y1FH
(When AD75 is mounted in slot 0 of the main base unit.)

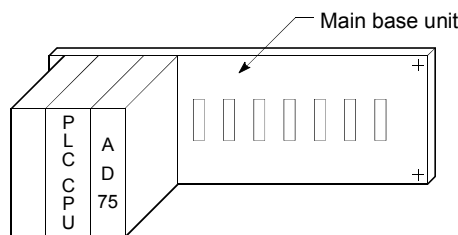

POINT

During the various processes of the special function module, the access from the PLC CPU is processed as a priority. Thus, if the special function module's buffer memory is frequently accessed from the PLC CPU, the PLC CPU scan time will increase and a delay will occur in the special function module's processes. Access the buffer memory from the PLC CPU with the FROM/TO command, etc., only when necessary.

6.2 List of devices used

The application of the input/output Nos. [X] [Y], internal relays [M] and data registers [D] used in this chapter are shown below.

Device name	Device			Application	Details when ON	
	Axis 1	Axis 2	Axis 3			
AD75	Input	X0		AD75 READY signal	Preparation incomplete/WDT error	
		X1	X2	X3	Positioning start complete signal	Start completed
		X4	X5	X6	BUSY signal	BUSY (operating)
		X7	X8	X9	Positioning complete signal	Positioning completed
		XA	XB	XC	Error detection signal	Error detected
		XD	XE	XF	M code ON signal	Outputting M code
	Output	Y10	Y11	Y12	Positioning start signal	Requesting start
		Y13	Y14	Y1C	Axis stop signal	Requesting stop
		Y16	Y18	Y1A	Forward run JOG start signal	Starting forward run JOG
		Y17	Y19	Y1B	Reverse run JOG start signal	Starting reverse run JOG
	Y1D		PLC READY signal	PLC CPU preparation completed		
Command	X20	—		Zero point return request OFF command	Commanding zero point return request OFF	
	X21	—		External start valid setting command	Commanding external start valid setting	
	X22	—		External start invalid command	Commanding external start invalid command	
	X23	—		Machine zero point return command	Commanding machine zero point return	
	X24	—		High-speed zero point return command	Commanding high-speed zero point return	
	X25	—		Positioning start command	Commanding positioning start	
	X26	—		Speed/position changeover operation command	Commanding speed/position changeover operation	
	X27	—		Speed/position changeover enable command	Commanding speed/position changeover enable	
	X28	—		Speed/position changeover prohibit command	Commanding speed/position changeover prohibit	
	X29	—		Movement amount change command	Commanding movement amount change	
	X2A	—		Advanced positioning control start command	Commanding advanced positioning control start	
	X2B	—		Positioning start command	Commanding positioning start	
	X2C	—		M code OFF command	Commanding M code OFF	
	X2D	—		JOG operation speed setting command	Commanding JOG operation speed setting	
	X2E	—		Forward run JOG command	Commanding forward run JOG operation	
	X2F	—		Reverse run JOG command	Commanding reverse run JOG	
	X30	—		Manual pulse generator operation enable command	Commanding manual pulse generator operation enable	
	X31	—		Manual pulse generator operation disable command	Commanding manual pulse generator operation disable	
X32	—		Speed change command	Commanding speed change		
X33	—		Override command	Commanding override		
X34	—		Acceleration/deceleration time change command	Commanding acceleration/deceleration time change		

Device name	Device			Application	Details when ON	
	Axis 1	Axis 2	Axis 3			
Command	X35	-		Acceleration/deceleration time change disable command	Commanding acceleration/deceleration time change disable	
	X36			Torque change command	Commanding torque change	
	X37			Step operation command	Commanding step operation	
	X38			Skip command	Commanding skip	
	X39			Teaching command	Commanding teaching	
	X3A			Continuous operation interrupt command	Commanding continuous operation interrupt	
	X3B			Restart command	Commanding restart	
	X3C			Parameter initialization command	Commanding parameter initialization	
	X3D			Flash ROM write command	Commanding flash ROM write	
	X3E			-		Error reset command
	X3F	Stop command	Commanding stop			
Internal relay	M0	-		Zero point return request OFF command	Commanding zero point return request OFF	
	M1			Zero point return request OFF command pulse	Zero point return request OFF commanded	
	M2			Zero point return request OFF command storage	Zero point return request OFF command held	
	M3			Clock data write command pulse	Clock data write commanded	
	M4			Clock data write command storage	Clock data write command held	
	M5	-		High-speed zero point return command	Requesting high-speed zero point return	
	M6			High-speed zero point return command storage	High-speed zero point return command held	
	M7			Positioning start command pulse	Positioning start commanded	
	M8			Positioning start command storage	Positioning start command held	
	M9			In JOG flag	In JOG flag	
	M10			Manual pulse generator operation enable command	Requesting manual pulse generator operation enable	
	M11			Manual pulse generator operating flag	Manual pulse generator operating flag	
	M12			Manual pulse generator operation disable command	Requesting manual pulse generator operation disable	
	M13			Speed change command pulse	Speed change commanded	
	M14			Speed change command storage	Speed change command held	
	M15			Override command	Requesting override	
	M16			Acceleration/deceleration time change command	Requesting acceleration/deceleration time change	
	M17			Torque change command	Requesting torque change	
	M18			Step operation command pulse	Step operation commanded	
	M19			Skip operation command pulse	Skip operation commanded	
	M20			Skip operation command storage	Skip operation command held	
	M21			Teaching command pulse	Teaching commanded	
	M22			Teaching command storage	Teaching command held	
	M23			Continuous operation interrupt command	Requesting continuous operation interrupt	
	M24			Restart command	Requesting restart	
M25	Restart command storage	Restart command held				

Device name	Device			Application	Details when ON		
	Axis 1	Axis 2	Axis 3				
Internal relay	M26			Parameter initialization command pulse	Parameter initialization commanded		
	M27			Parameter initialization command storage	Parameter initialization command held		
	M28			Flash ROM write command pulse	Flash ROM write commanded		
	M29			Flash ROM write command storage	Flash ROM write command held		
	M30	-		Error code read complete	Error code read completed		
	M31			Error reset	Error reset completed		
	M32			Stop command pulse	Stop commanded		
	M9028			Clock data read command	Requesting clock data read		
	M9036			Always ON contact	Always ON contact		
	M9038			1 scan ON after RUN	1 scan turned ON after RUN		
	M9039			1 scan OFF after RUN	1 scan turned OFF after RUN		
Data register	D0	-		Status information	([Md.40] Status)		
	D1			Zero point return request flag	([Md.40] Status (bit3))		
	D2			Zero point return request OFF results	([Cd.24] Zero point return request flag OFF request)		
	D3			Date/hour data	PLC CPU clock data		
	D4			Minute/second data			
	D5	-		Clock data write request	([Cd.3] Clock data writing)		
	D6			Clock data write results	([Cd.3] Clock data writing)		
	D7			Positioning data No.	Positioning data No.		
	D8			Movement amount (low-order 16 bits)	([Cd.21] Speed/position changeover control movement amount change register)		
	D9			Movement amount (high-order 16 bits)			
	D10			JOG operation speed (low-order 16 bits)	([Cd.19] JOG speed)		
	D11			JOG operation speed (high-order 16 bits)			
	D12			Manual pulse generator 1 pulse input magnification (low-order)	([Cd.23] Manual pulse generator 1 pulse input magnification)		
	D13			Manual pulse generator 1 pulse input magnification (high-order)			
	D14			Speed change value (low-order 16 bits)	([Cd.16] New speed value)		
	D15			Speed change value (high-order 16 bits)			
	D16			Speed change request	([Cd.17] Speed change request)		
	D17			Speed change result	([Cd.17] Speed change request)		
	D18			Override value	([Cd.18] Positioning operation speed override)		
	D19			Acceleration time setting (low-order 16 bits)	([Cd.33] New acceleration time value)		
	D20			Acceleration time setting (high-order 16 bits)			
	D21			Deceleration time setting (low-order 16 bits)	([Cd.34] New deceleration time value)		
	D22			Deceleration time setting (high-order 16 bits)			
	D23			Torque limit value	([Md.45] Torque Limit stored value)		
	D24			Step valid flag	([Cd.26] Step valid flag)		
	D25			Step mode	([Cd.27] Step mode)		
	D26			Skip operation results	([Cd.29] Skip command)		
	D27			Target axis	([Cd.4] Target axis)		
	D28			Positioning data No.	([Cd.5] Positioning data No.)		
D29				Write pattern	([Cd.6] Write pattern)		

Device name	Device			Application	Details when ON	
	Axis 1	Axis 2	Axis 3			
Data register		D30		Read/write request	([Cd.7] Read/write request)	
		D31		Teaching results	([Cd.7] Read/write request)	
		D32		Axis state	([Md.35] Axis operation status)	
		D33		Restart request	([Cd.13] Restart command)	
		D34		Parameter initialization results	([Cd.10] Parameter initialization request)	
		D35		Flash ROM write results	([Cd.9] Flash ROM write request)	
		D36		Error code	([Md.33] Axis error No.)	
		D40		Positioning identifier	([Da.1] to [Da.4])	
		D41		M code	([Da.9] M code)	
		D42		Dwell time	([Da.8] Dwell time)	
		D43		Blank	Blank	
		D44		Speed command (low-order 16 bits)	([Da.7] Command speed)	
		D45		Speed command (high-order 16 bits)		
		D50		Unit setting	([Pr.1] Unit setting)	
		D51		No. of pulses per rotation	([Pr.2] No. of pulses per rotation)	
		D52		Movement amount per rotation	([Pr.3] Movement amount per rotation)	
		D53		Unit magnification	([Pr.4] Unit magnification)	
		D54		Pulse output mode	([Pr.5] Pulse output mode)	
		D55		Rotation direction setting	([Pr.6] Rotation direction setting)	
		D56		Positioning identifier	([Da.1] Operation pattern)	
					([Da.2] Control method)	
					([Da.3] Acceleration time No.)	
					([Da.4] Deceleration time No.)	
		D57	-	M code	([Da.9] M code)	
		D58		Dwell time	([Da.8] Dwell time)	
		D59		(Dummy)	-	
		D60		Command speed (low-order 16 bits)	([Da.7] Command speed)	
		D61		Command speed (high-order 16 bits)		
		D62		Positioning address/movement amount	([Da.5] Positioning address/movement amount)	
		D63				(low-order 16 bits)
		D64		Arc address	([Da.6] Arc address)	
		D65				(high-order 16 bits)
		D66		1st point (Shape, start No.)	([Da.10] Shape) ([Da.11] Start data No.) ([Da.12] Special start command) ([Da.13] Parameter)	
		D67		2nd point (Shape, start No.)		
		D68		3rd point (Shape, start No.)		
		D69		4th point (Shape, start No.)		
		D70		5th point (Shape, start No.)		
		D71		1st point (Special start command)		
		D72		2nd point (Special start command)		
		D73		3rd point (Special start command)		
		D74		4th point (Special start command)		
		D75		5th point (Special start command)		
		D9026		Date/hour data		Clock data
		D9027		Minute/second data		
	Timer	T0		PLC READY signal OFF confirmation		PLC READY signal OFF
T1			PLC READY signal OFF confirmation			

6.3 Creating a program

The "positioning control operation program" actually used is explained in this chapter. The functions and programs explained in "SECTION 2" are assembled into the "positioning control operation program" explained here. (To monitor the control, add the required monitor program that matches the system. Refer to section "5.6 List of monitor data" for details on the monitor items.)

6.3.1 General configuration of program

The general configuration of the "positioning control operation program" is shown below.

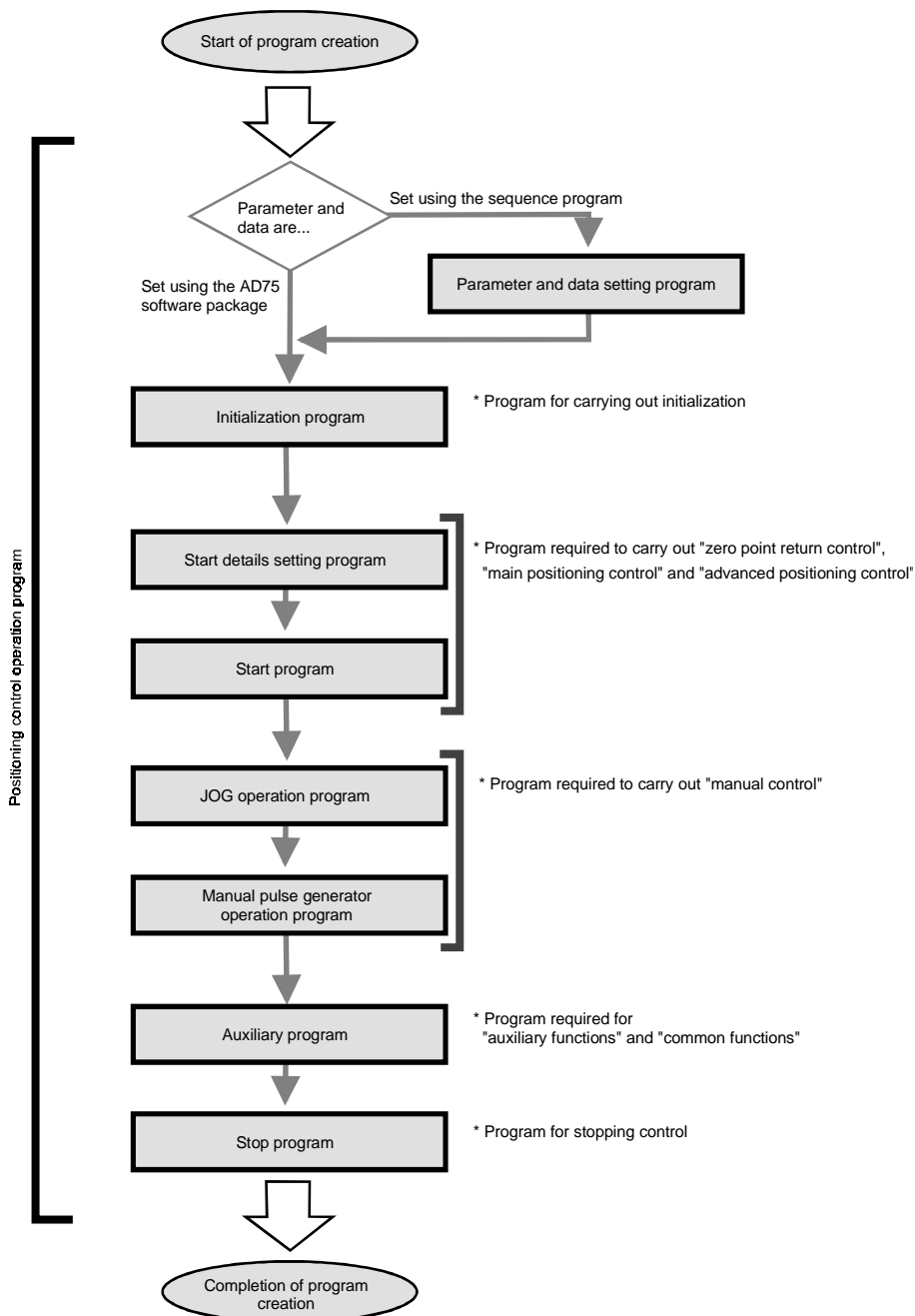

6.3.2 Positioning control operation program

The various programs that configure the "positioning control operation program" are shown below. When creating the program, refer to the explanation of each program and section "6.4 Positioning program examples", and create an operation program that matches the positioning system. (Numbers are assigned to the following programs. Configuring the program in the order of these numbers is recommended.)

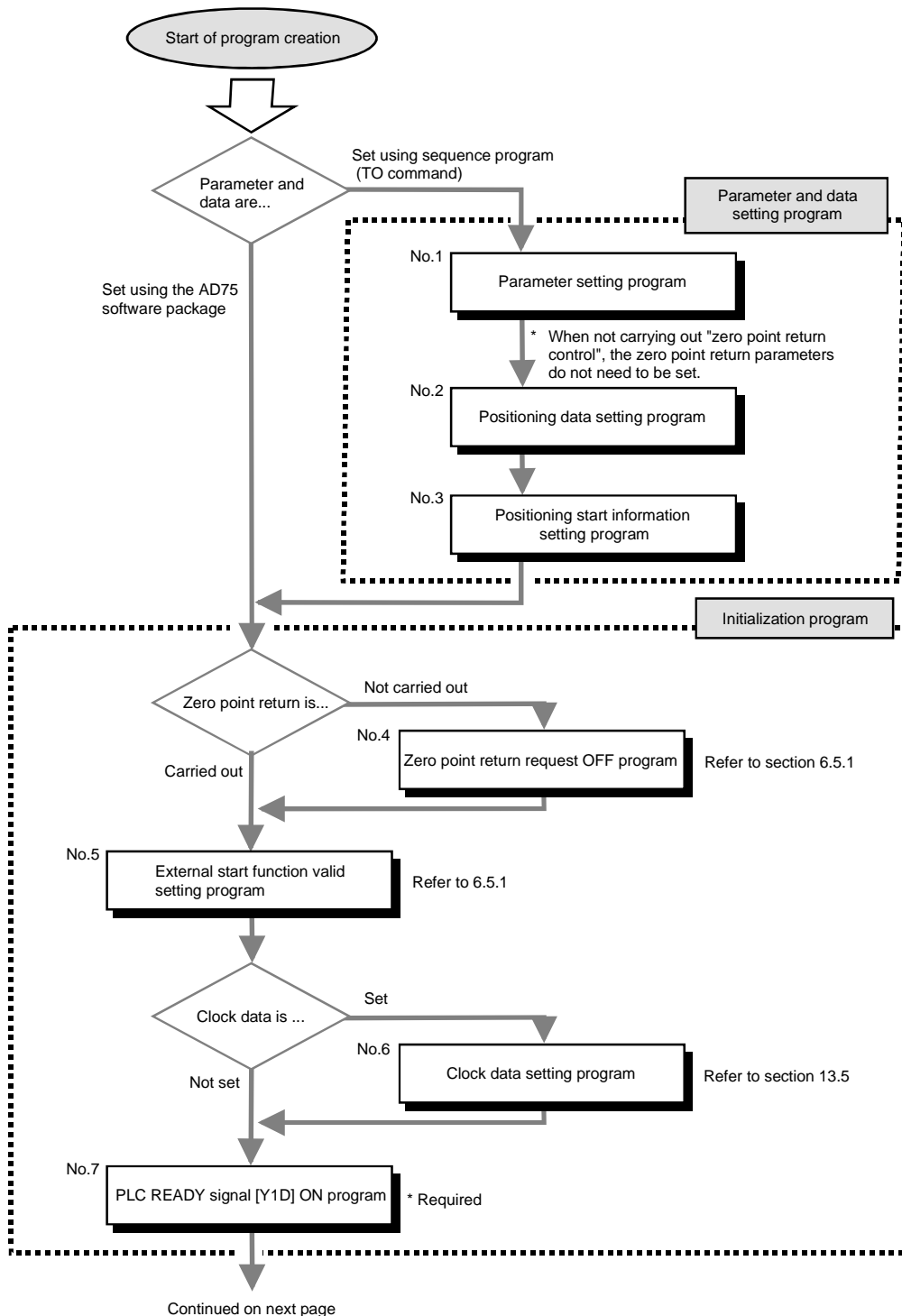

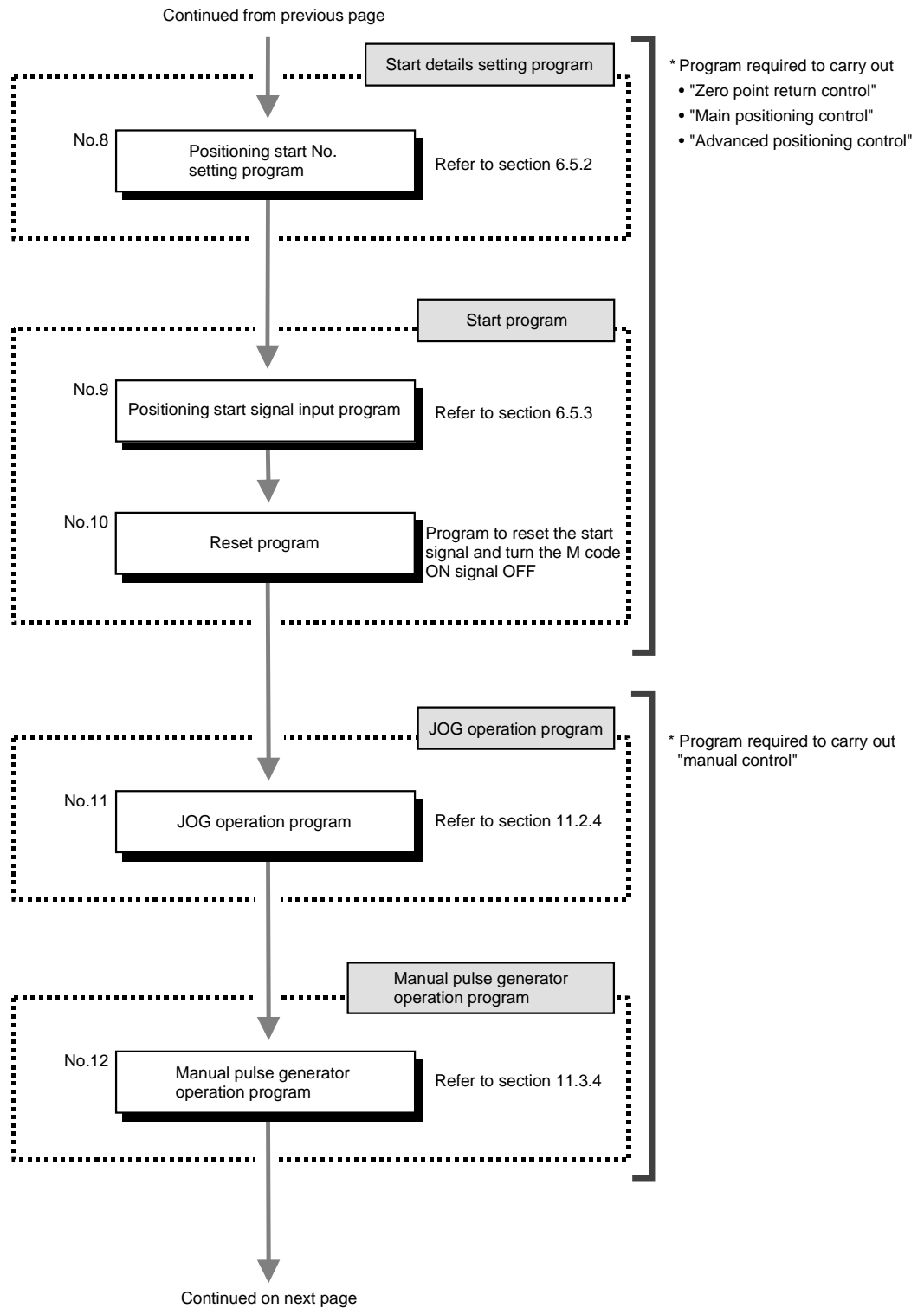

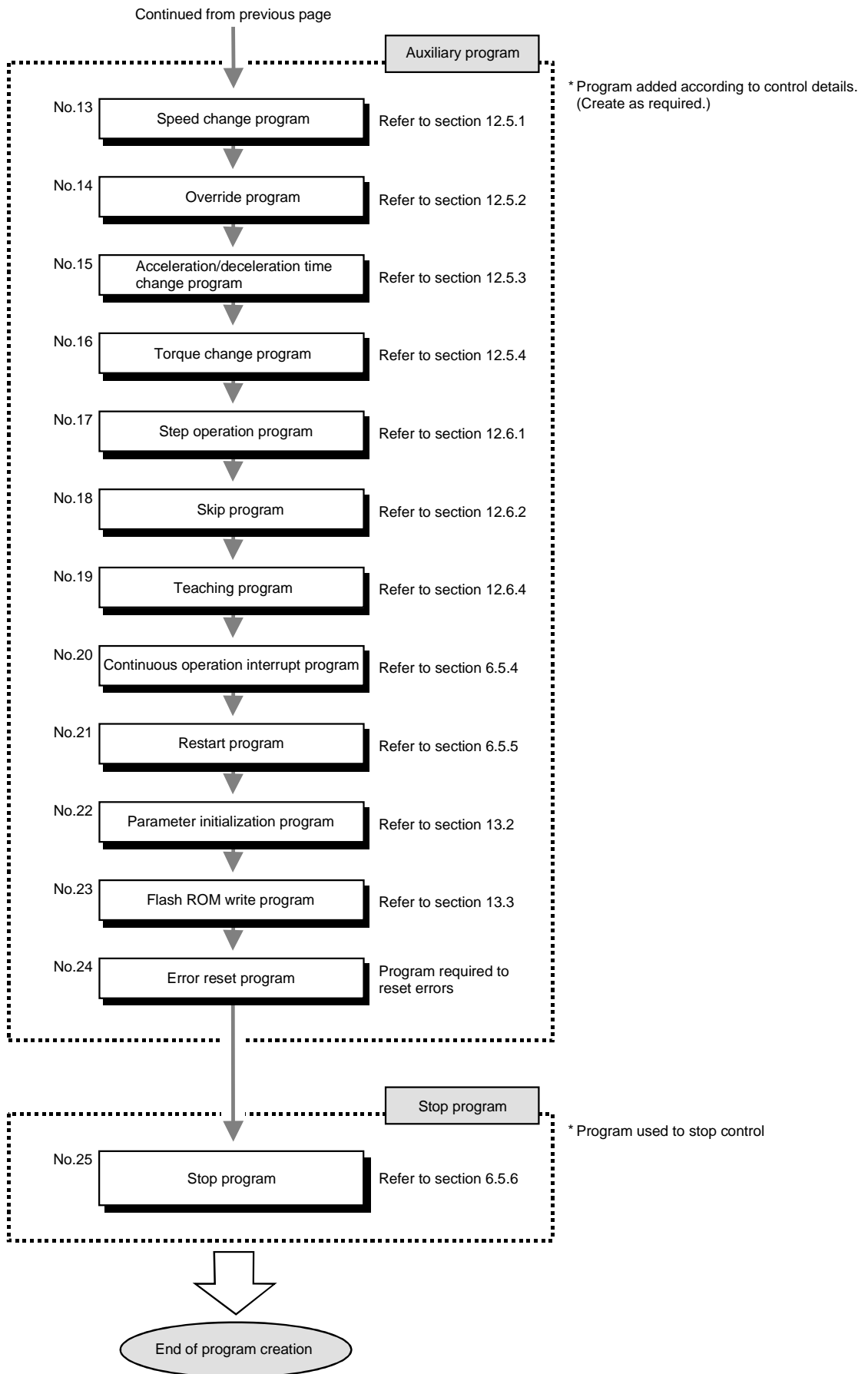

6.4 Positioning program examples

An example of the "Axis 1" positioning program is given in this section.

----- [No. 1] to [No. 3] parameter and data setting program -----

* When setting the parameters or data with the sequence program, set them in the AD75 using the TO command from the PLC CPU. (Carry out the settings while the PLC READY signal [Y1D] is OFF.)

* When setting the parameters or data with the AD75 software package, the [No. 1] to [No. 3] program is not necessary.

* No.1 Parameter setting program
 * (For basic parameter 1 axis 1)

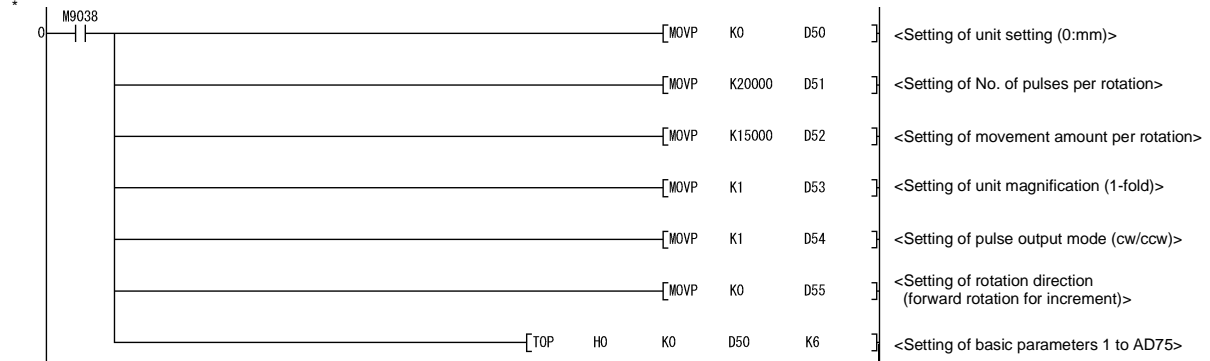

* No.2 Positioning data setting program
 * (For positioning data No.1 axis 1)

<Positioning identifier>
 * Operation pattern : Positioning complete
 * Control method : 1-axis liner control (ABS)
 * Acceleration time No.:1, Deceleration time No.:2

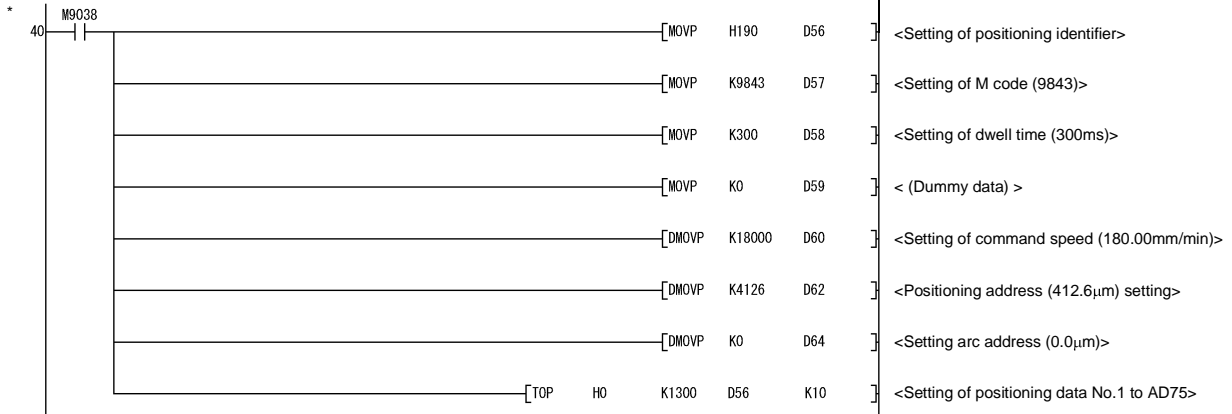

*
 * No.3 Positioning start information setting program
 * Start block data of block No.7000 (axis 1)
 * For setting of points 1 to 5
 * (Conditions)
 * Shapes: Continued at points 1 to 4, ended at point 5
 * Special start command : Normal start at all of points 1 to 5
 * <Positioning data are already preset>

* [Setting of shape and start data No.]

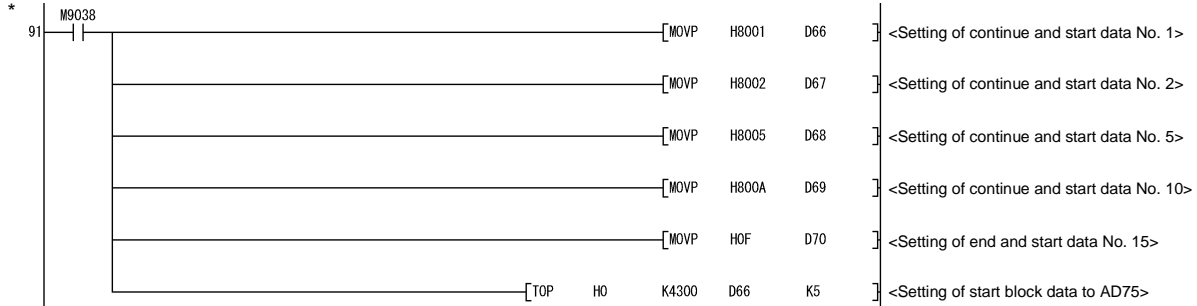

* [Setting of special start command to normal start]

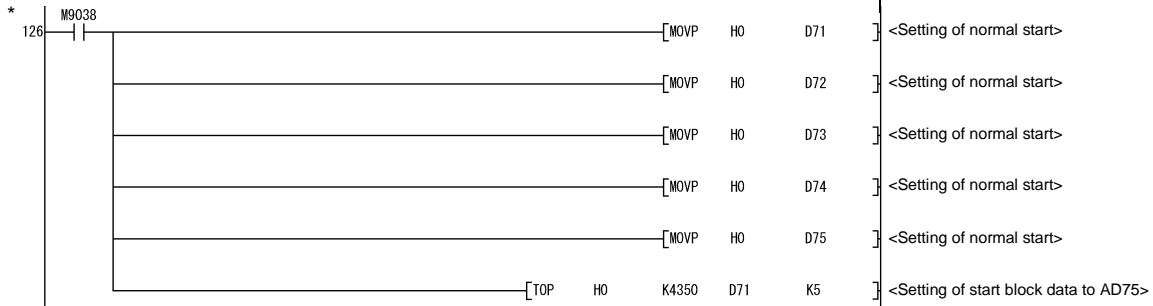

* No.4 Zero point return request OFF program

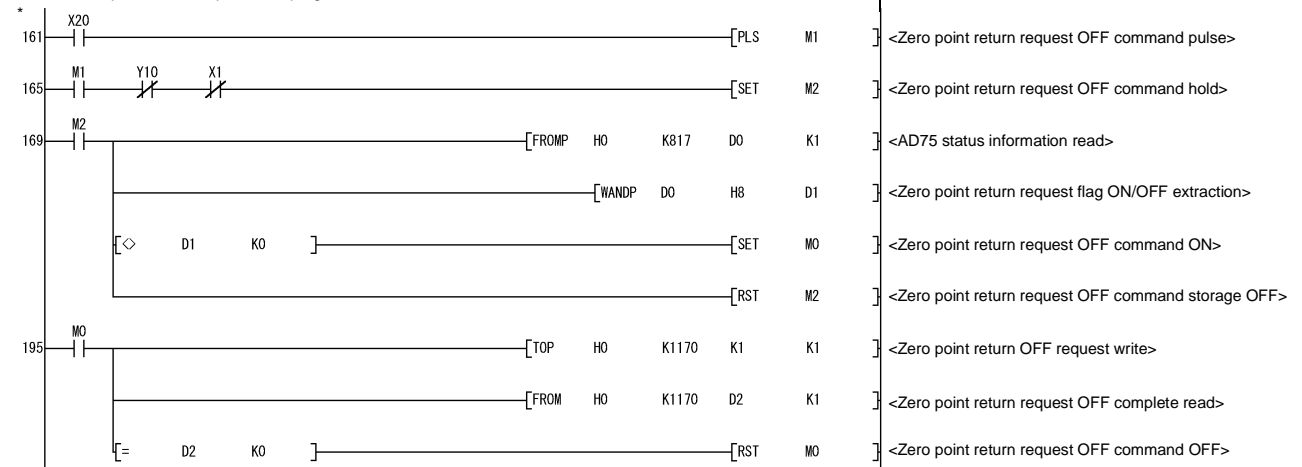

* No.5 External start function valid setting program

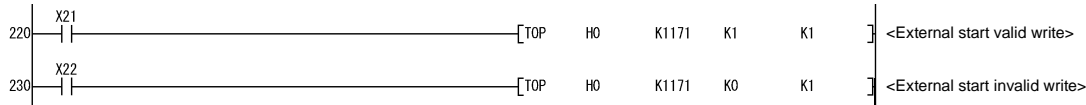

* No.6 Clock data setting program

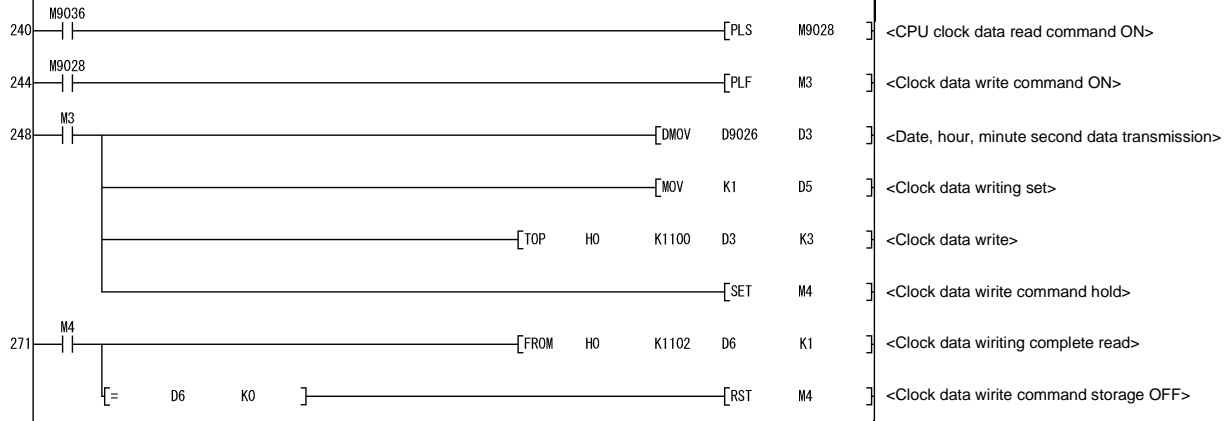

* No.7 PLC READY signal [Y1D] ON program
 * (The M27 contact is not required when the parameters are not be initialized.)
 * (The M29 contact is not required when not writing to the flash ROM.)

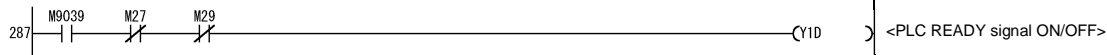

* No.8 Positioning start No. setting program

* (1) Machine zero point return

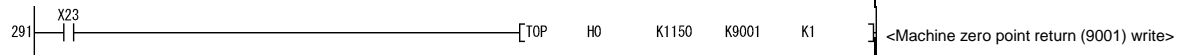

* (2) High-speed zero point return

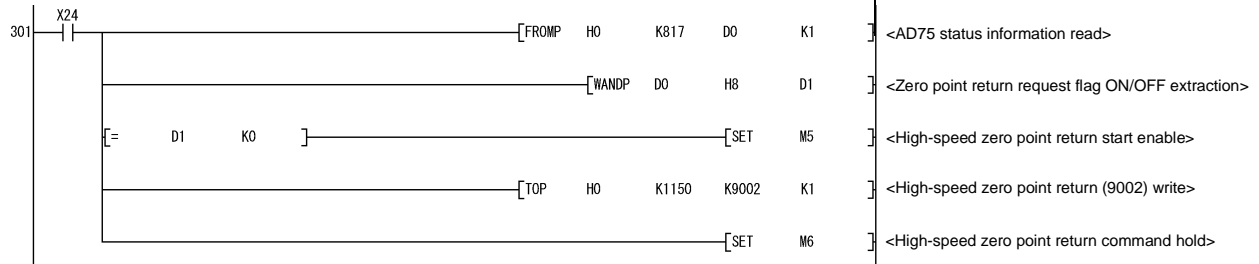

* (3) Positioning with positioning data No.1 (Control other than speed/position changeover control)

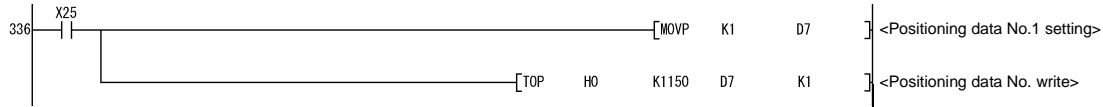

* (4) Positioning with positioning data No.1 (Speed/position changeover control)

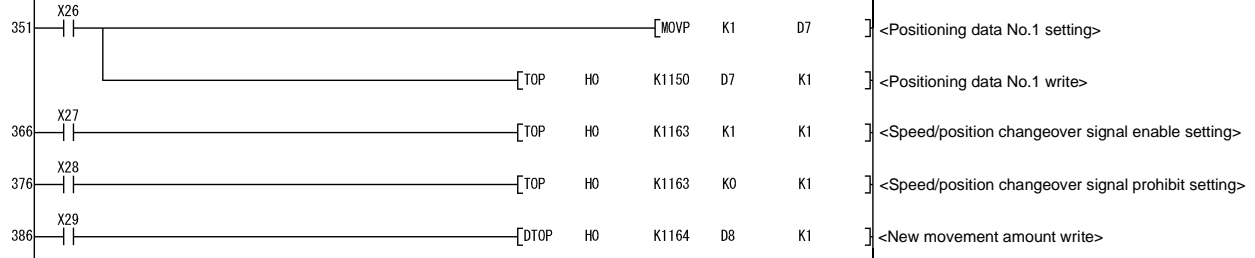

* (5) Advanced positioning control

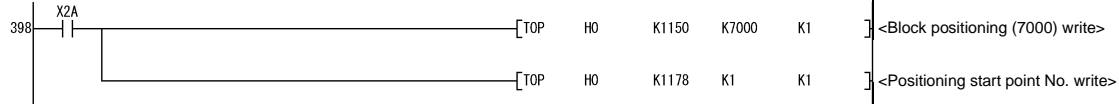

* (6) High-speed zero point return command and high-speed zero point return command storage OFF
 (Not required when high-speed zero point return is not used)

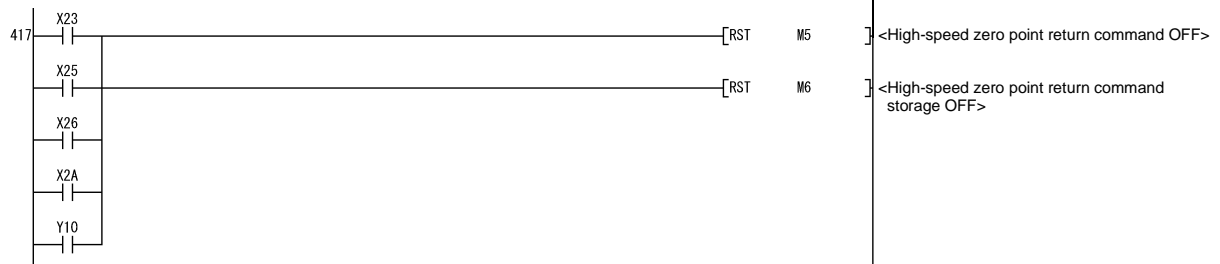

* No.9 Positioning start signal input program

- * (When high-speed zero point return is not made, contacts of M5 and M6 are not needed.)
- * (When M code is not used, contact of X0D is not needed.)
- * (When JOG operation is not performed, contact of M9 is not needed.)
- * (When manual pulse generator operation is not performed, contact of M11 is not needed.)

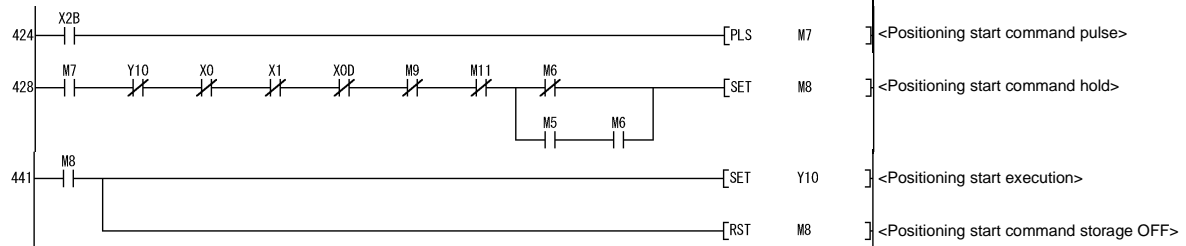

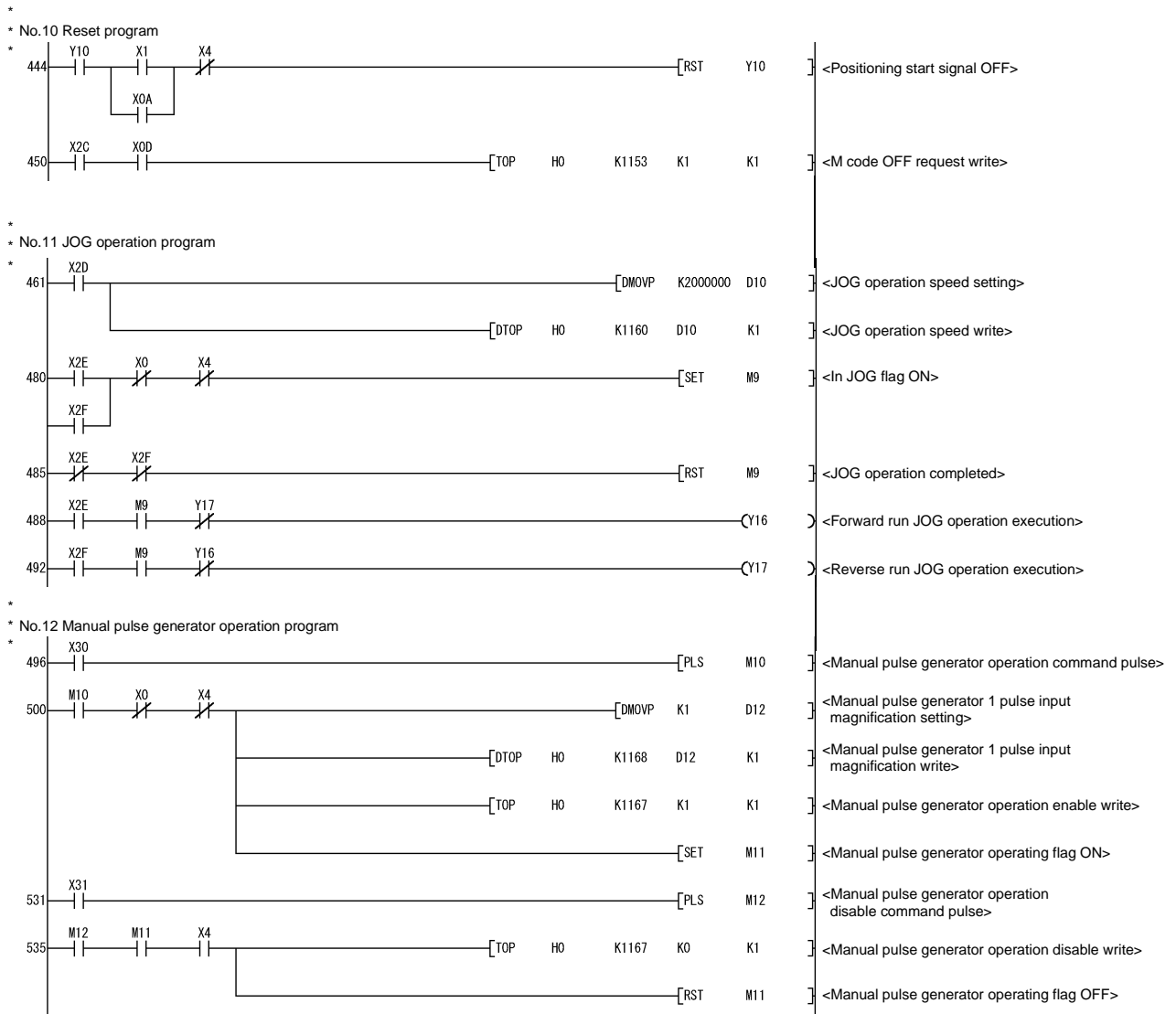

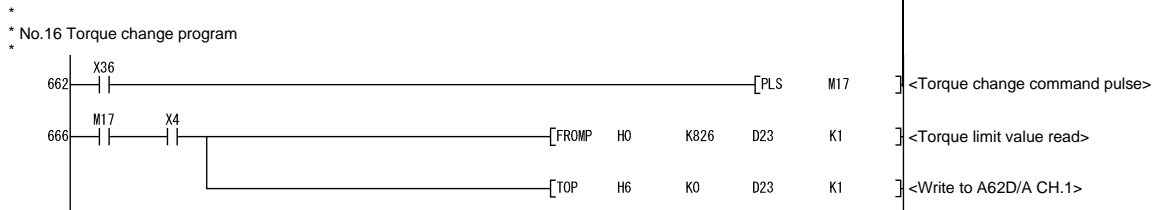
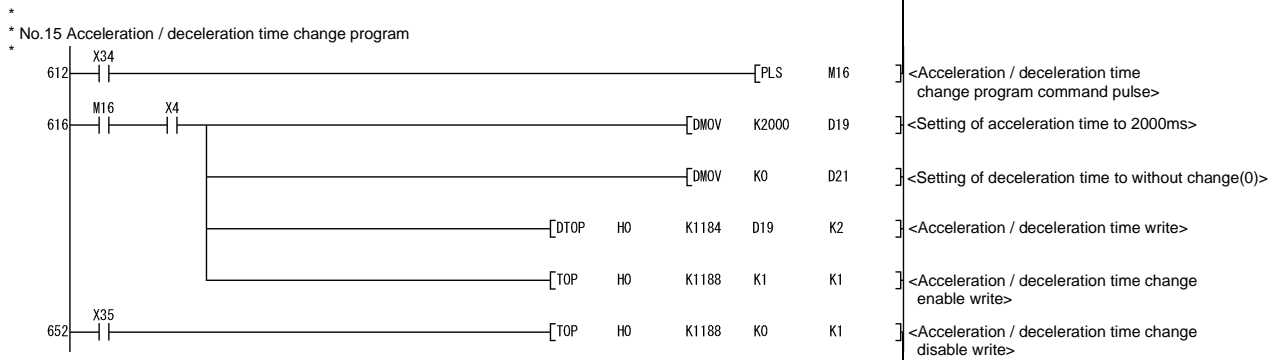
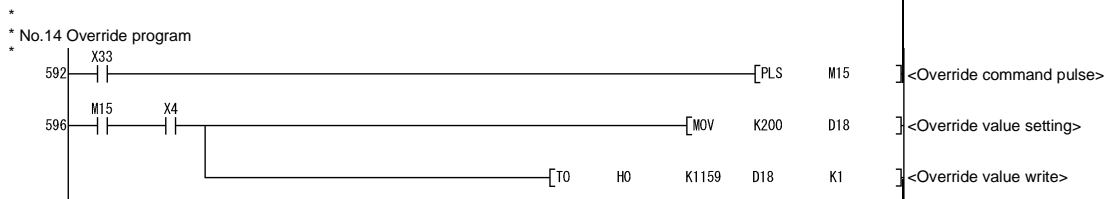
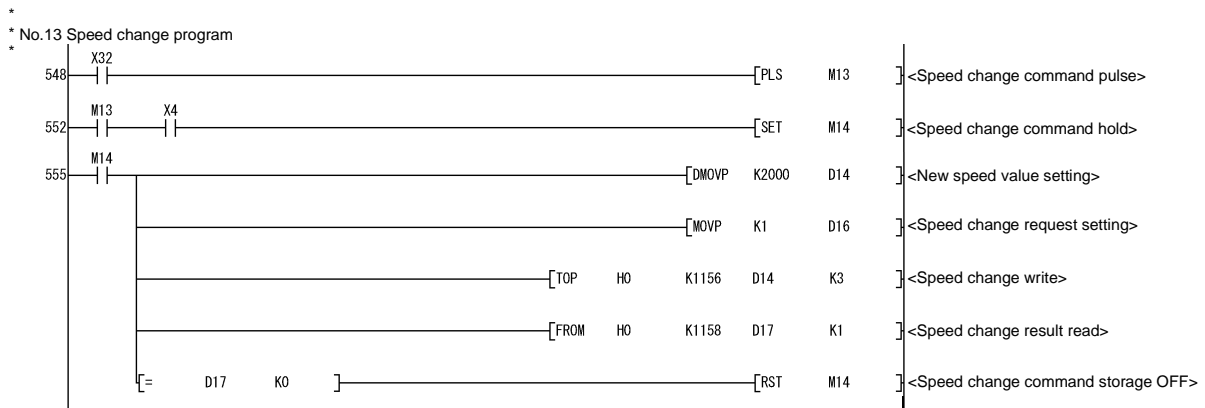

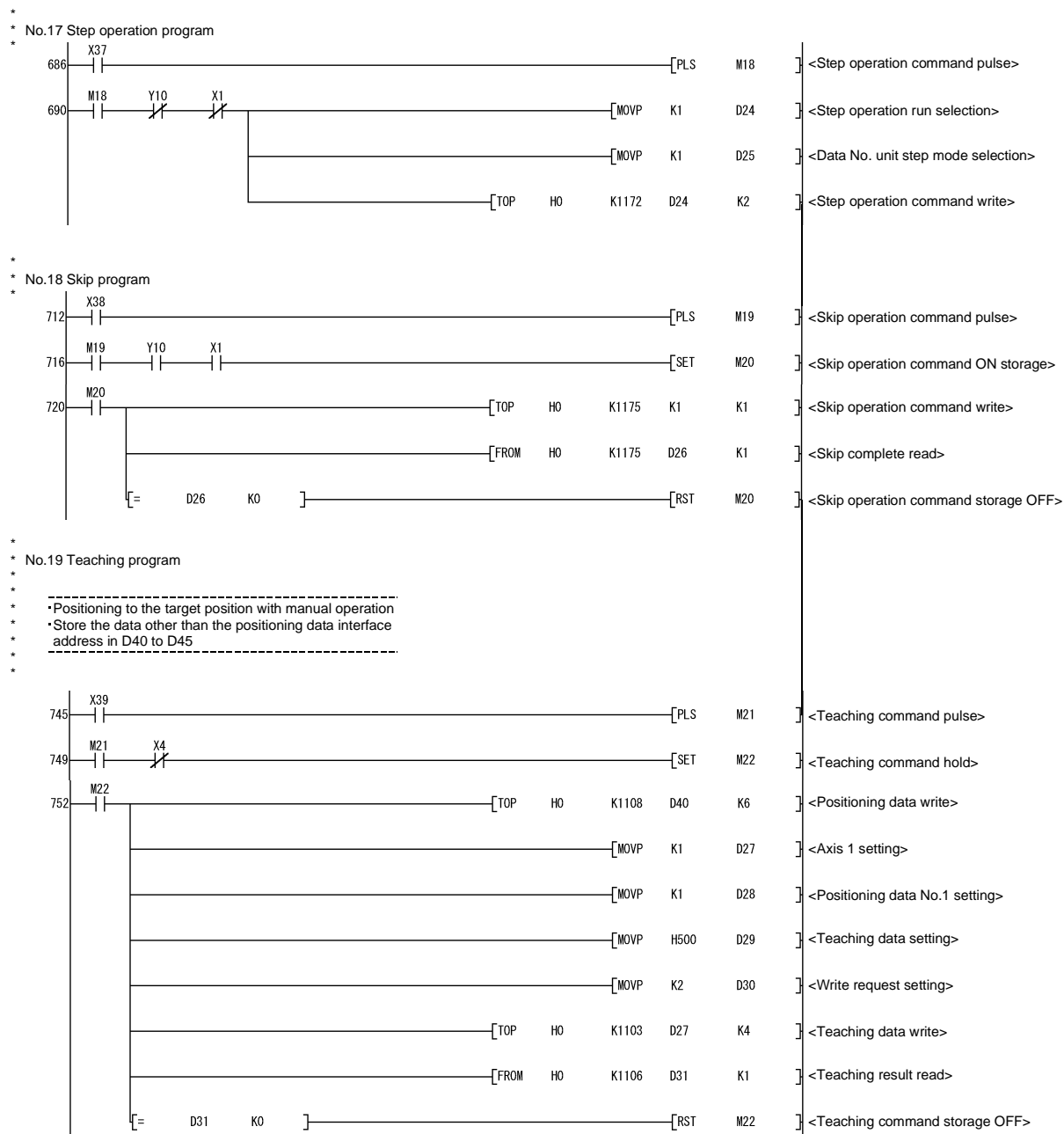

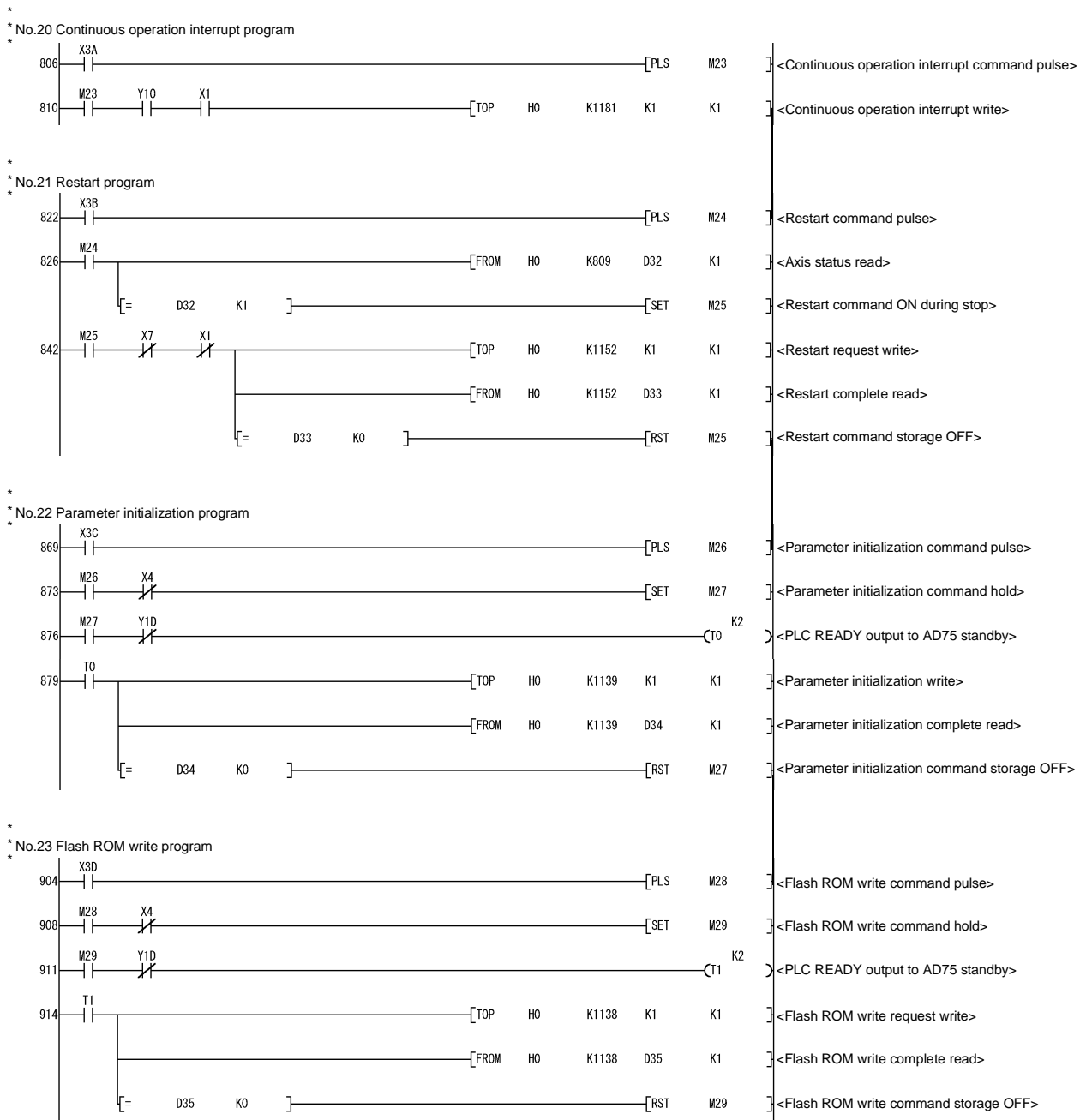

*
* No.24 Error reset program
*

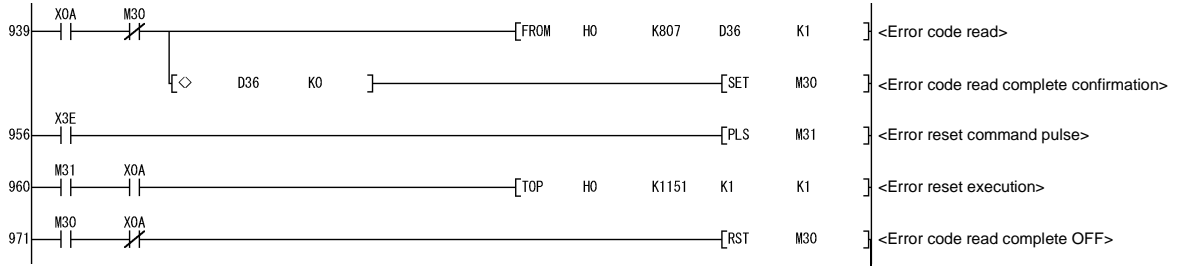

*
* No.25 Stop program
*

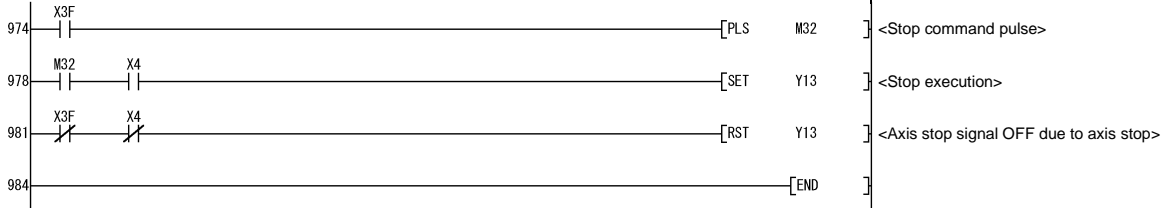

6.5 Program details

6.5.1 Initialization program

(1) Zero point return request OFF program

This program forcibly turns OFF the "zero point return request flag" (Md.40 Status : b3) which is ON.

When using a system that does not require zero point return, assemble the program to cancel the "zero point return request" made by the AD75 when the power is turned ON, etc.

■ Data requiring setting

Set the following data to use the zero point return flag OFF request.

Setting item	Setting value	Setting details	Buffer memory address		
			Axis 1	Axis 2	Axis 3
Cd.24 Zero point return request flag OFF request	1	Set to "1: Turn zero point return request flag OFF".	1170	1220	1270

* Refer to section "5.7 List of control data" for details on the setting details.

■ Time chart for zero point return OFF request

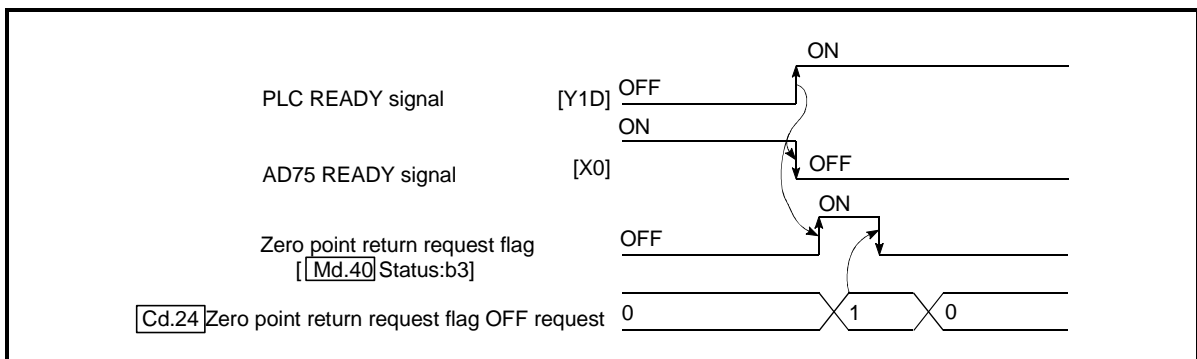

Fig. 6.1 Time chart for zero point return OFF request

(2) External start function valid setting program

This program is used to validate the "external signal" beforehand when using the external start function (external start, speed change, skip). (Set which function to use beforehand in "Pr.43 External start function selection".)

Set the following data to validate the "external signal".

Setting item	Setting value	Setting details	Buffer memory address		
			Axis 1	Axis 2	Axis 3
Cd.25 External start valid	1	Set to "1: Validate external start".	1171	1221	1271

* Refer to section "5.7 List of control data" for details on the setting details.

6.5.2 Start details setting program

This program sets which control, out of "zero point control", "main positioning control" or "advanced positioning control" to execute. For "advanced positioning control", "high-speed zero point return" and "speed/position changeover control", add the respectively required sequence program.

(Refer to "Chapter 10" for details on starting the "advanced positioning control.")

■ Procedures for setting the starting details

- (1) Set the "positioning start No." corresponding to the control to be started in "[Cd.11] Positioning start No."

Setting item	Setting value	Setting details	Buffer memory address		
			Axis 1	Axis 2	Axis 3
[Cd.11] Positioning start No.	→	1 to 600 : Positioning data No. 9001 : Machine zero point return 9002 : High-speed zero point return 9003 : Current value change 7000 to 7010 : Block No. (For "advanced positioning control")	1150	1200	1250

* Refer to section "5.7 List of control data" for details on the setting details.

- (2) For "advanced positioning control", set the "positioning start point No." of the block to be started in "[Cd.31] Positioning start point No."

Setting item	Setting value	Setting details	Buffer memory address		
			Axis 1	Axis 2	Axis 3
[Cd.31] Positioning start point No.	→	1 to 50 : Point No. of start block data	1178	1228	1278

* Refer to section "5.7 List of control data" for details on the setting details.

- (3) For "high-speed zero point return", confirm that the "zero point absolute position overflow flag/underflow flag" is OFF.

- (4) Set the following control data for "speed/position changeover control".
(Set "[Cd.21] Speed/position changeover control movement amount change register" as required.)

Setting item	Setting value	Setting details	Buffer memory address		
			Axis 1	Axis 2	Axis 3
[Cd.20] Speed/position changeover enable flag	1	When "1" is set, the speed/position changeover signal will be validated.	1163	1213	1263
[Cd.21] Speed/position changeover control movement amount change register	→	Set the new value when the position control's movement amount is to be changed during speed control.	1164 1165	1214 1215	1264 1265

* Refer to section "5.7 List of control data" for details on the setting details.

6.5.3 Start program

This program is used to start the control with start commands.
 The control can be started with the following two methods.

- (1) Starting by inputting positioning start signal [Y10, Y11, Y12]
- (2) Starting by inputting external start signal

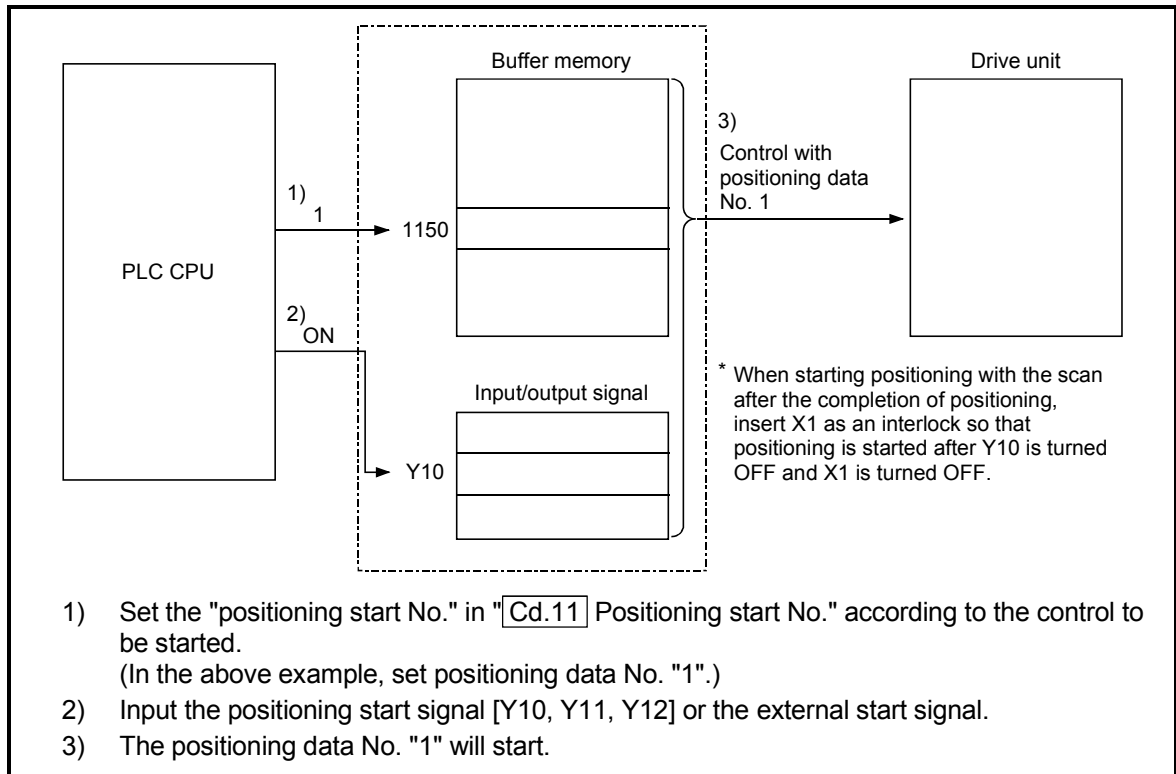

Fig. 6.2 Procedures for starting control

■ Starting conditions

When starting, the following conditions must be satisfied. The program must be configured by adding the required conditions into the sequence program so that the operation does not start until the conditions are satisfied.

Signal name		Signal state		Device		
				Axis 1	Axis 2	Axis 3
Interface signal	PLC READY signal	ON	PLC CPU preparation completed	Y1D		
	AD75 READY signal	OFF	AD75 preparation completed	X0		
	Axis stop signal	OFF	Axis stop signal is OFF	Y13	Y14	Y1C
	Start complete signal	OFF	Start complete signal is OFF	X1	X2	X3
	BUSY signal	OFF	BUSY signal is OFF	X4	X5	X6
	Error detection signal	OFF	There is no error	XA	XB	XC
	M code ON signal	OFF	M code ON signal is OFF	XD	XE	XF
External signal	Drive unit READY signal	ON	Drive unit preparation completed	-		
	Stop signal	OFF	Stop signal is OFF	-		
	Upper limit (FLS)	ON	Within limit range	-		
	Lower limit (RLS)	ON	Within limit range	-		

(1) Starting by inputting positioning start signal

■ Operation when starting

- (1) When the positioning start signal turns ON, the start complete signal and BUSY signal turn ON, and the positioning operation starts.
It can be seen that the axis is operating when the BUSY signal is ON.
- (2) When the positioning start signal turns OFF, the start complete signal also turns OFF.
If the positioning start signal is ON even after positioning is completed, the start complete signal will remain ON.
- (3) If the positioning start signal turns ON again while the BUSY signal is ON, a warning "start during operation" (warning code: 100) is caused.
- (4) The process taken when positioning is completed will differ according to case (a) and (b) below.
 - (a) When next positioning is not to be carried out
 - If a dwell time is set, the system will wait for the set time to pass, and then positioning will be completed.
 - When positioning is completed, the BUSY signal will turn OFF and the positioning complete signal will turn ON. However, when using speed control or when the positioning complete signal ON time is "0", the signal will not turn ON.
 - When the positioning complete signal ON time is passed, the positioning complete signal will turn OFF.
 - (b) When next positioning is to be carried out
 - If a dwell time is set, the system will wait for the set time to pass.
 - When the set dwell time is passed, the next positioning will start.

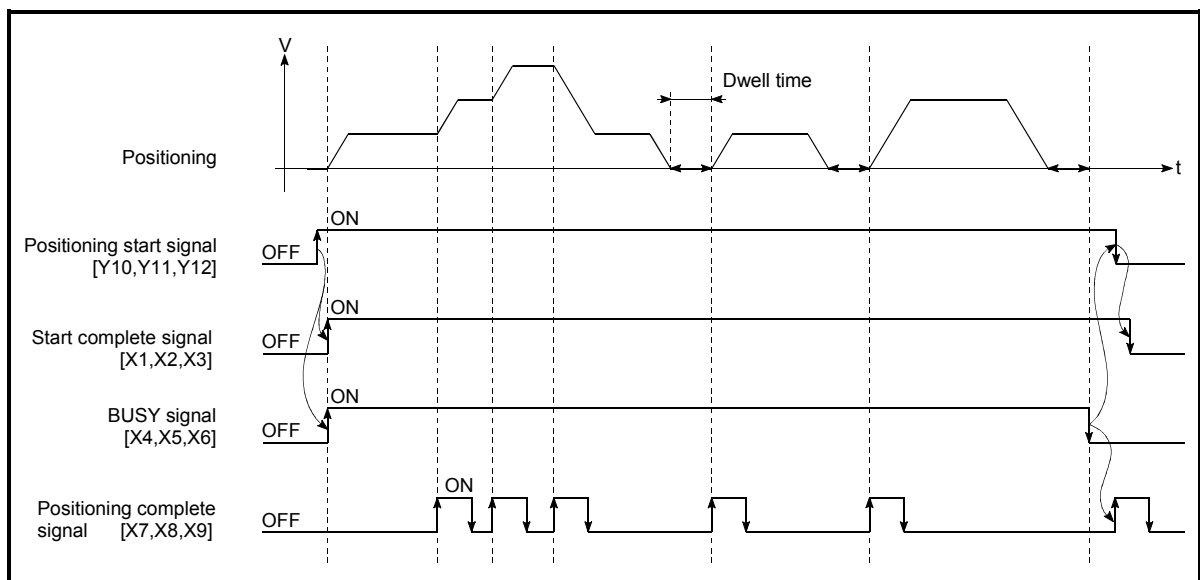

Fig. 6.3 ON/OFF timing of each signal at start of positioning

POINT

When position control of movement amount 0 is executed, the BUSY signal [X4, X5, X6] also turns ON. However, since the ON time is short, the ON status may not be detected in the sequence program.

(The ON statuses of the start complete signal [X1, X2, X3], positioning complete signal [X7, X8, X9] and M code ON signal [XD, XE, XF] can be detected in the sequence program.)

■ Starting time chart

The time chart for starting each control is shown below.

(1) Time chart for starting "machine zero point return"

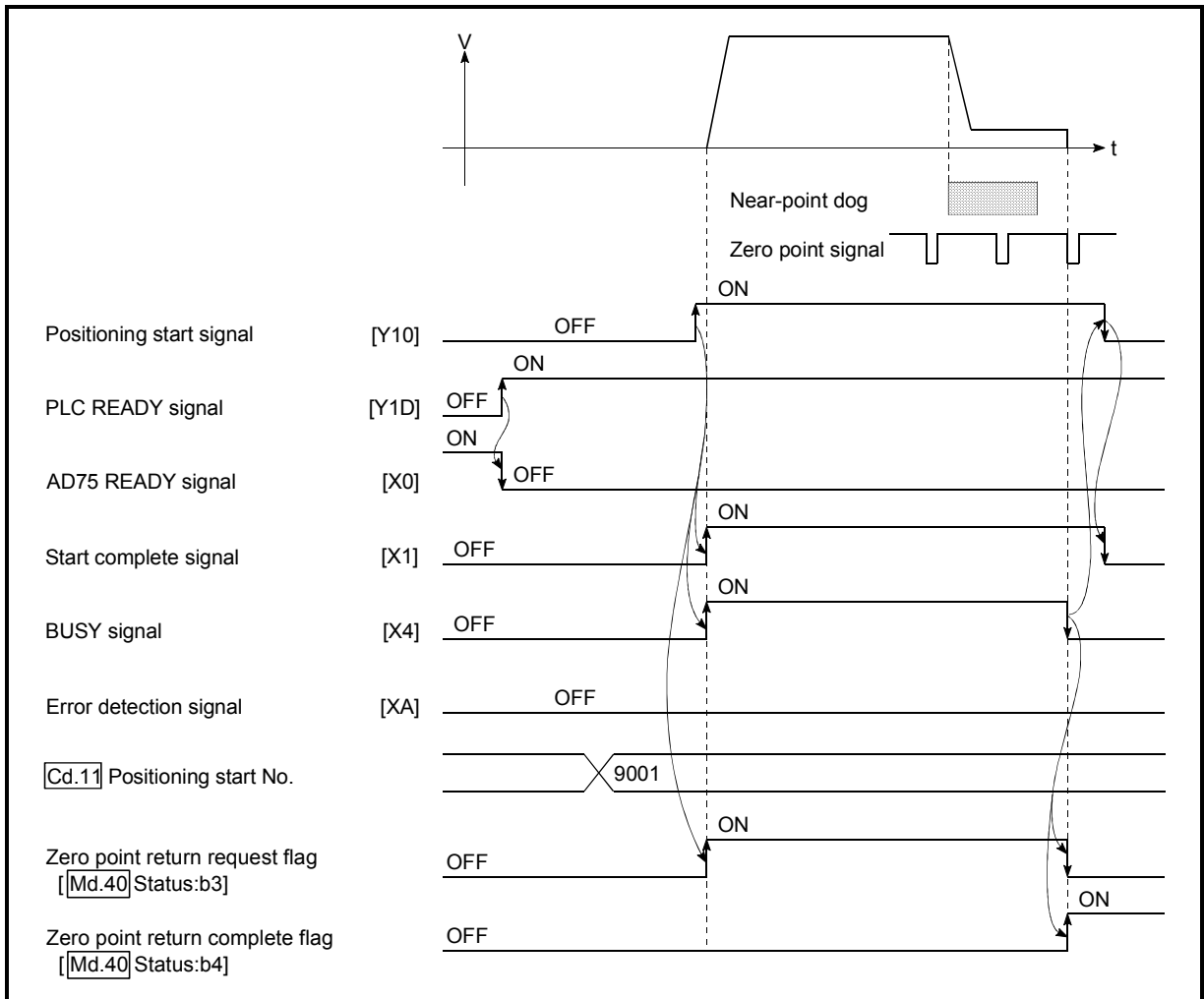

Fig. 6.4 Time chart for starting "machine zero point return"

(2) Time chart for starting "high-speed zero point return"

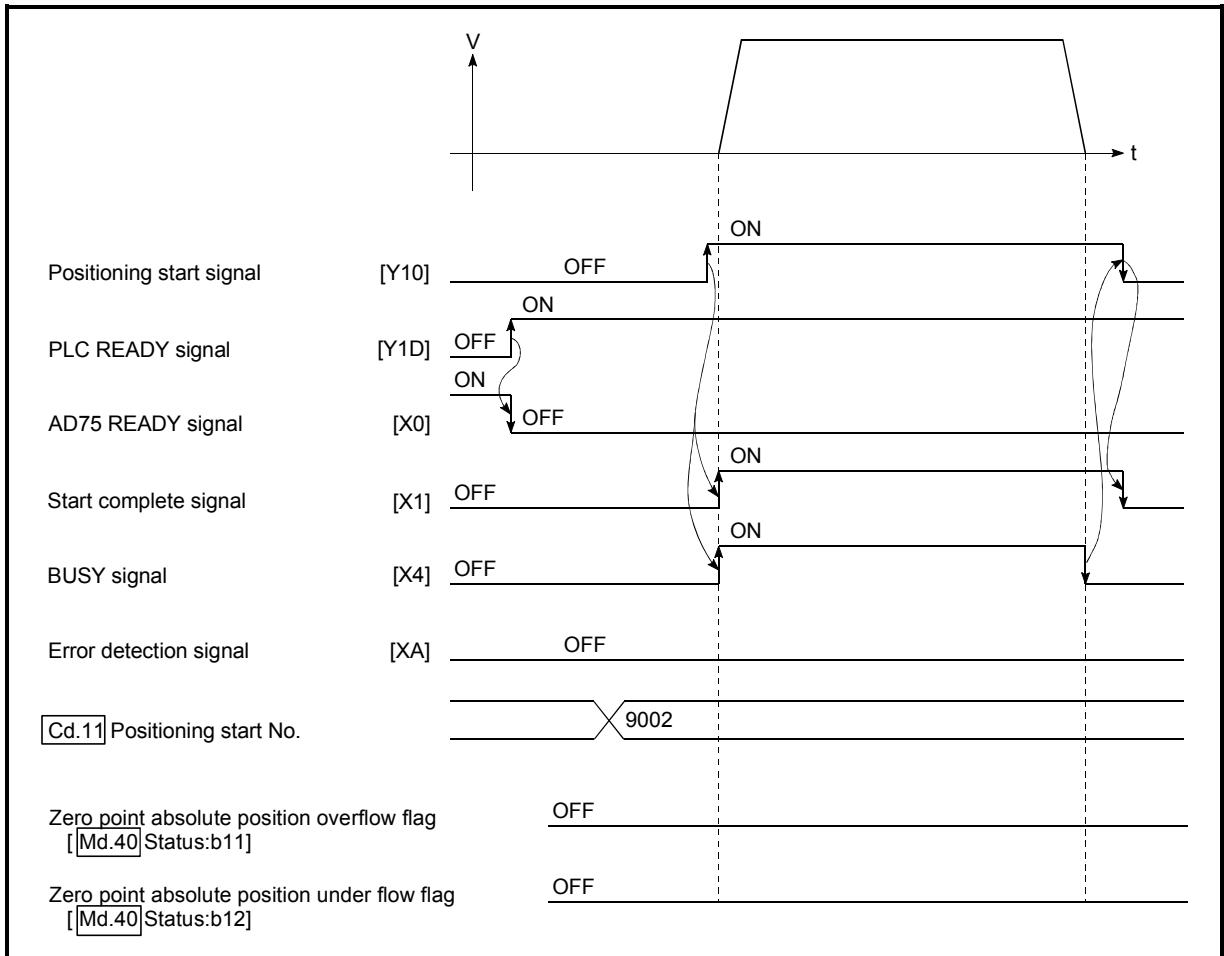

Fig. 6.5 Time chart for starting "high-speed zero point return"

(3) Time chart for starting "main positioning control"

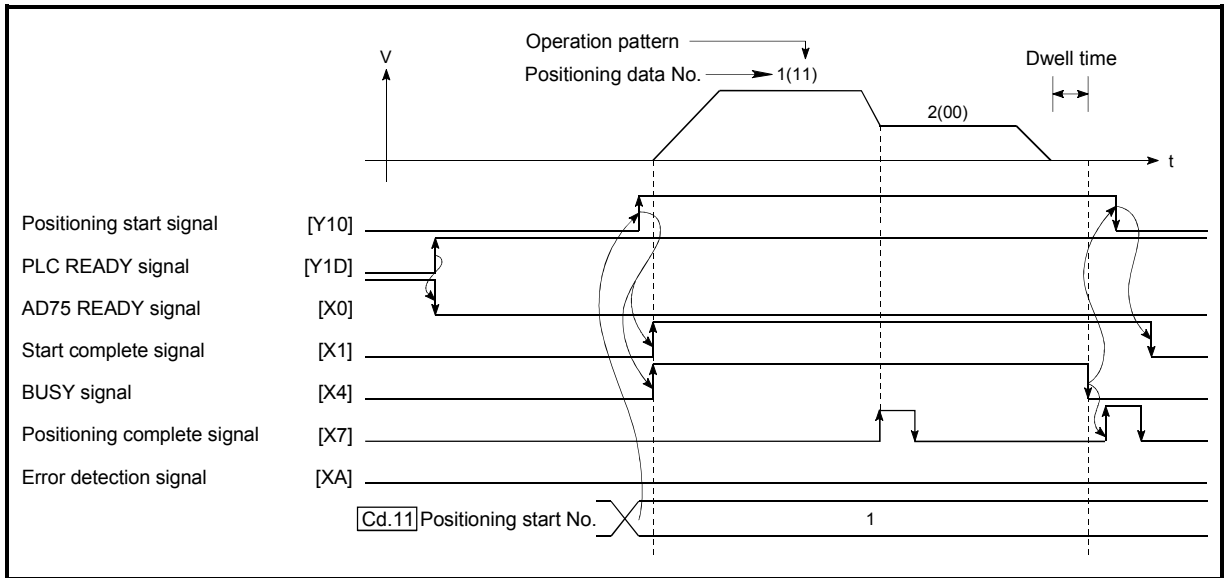

Fig. 6.6 Time chart for starting "main positioning control"

(4) Time chart for starting "speed/position changeover control"

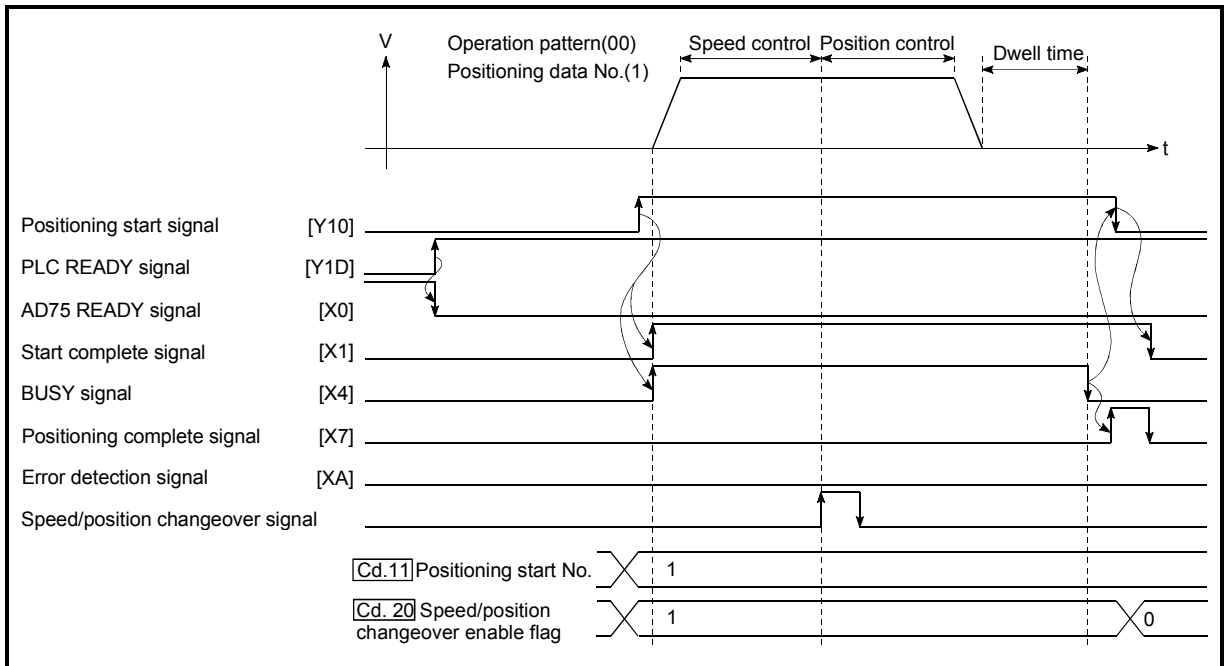

Fig. 6.7 Time chart for starting "speed/position changeover control"

■ Machine zero point return operation timing and process time

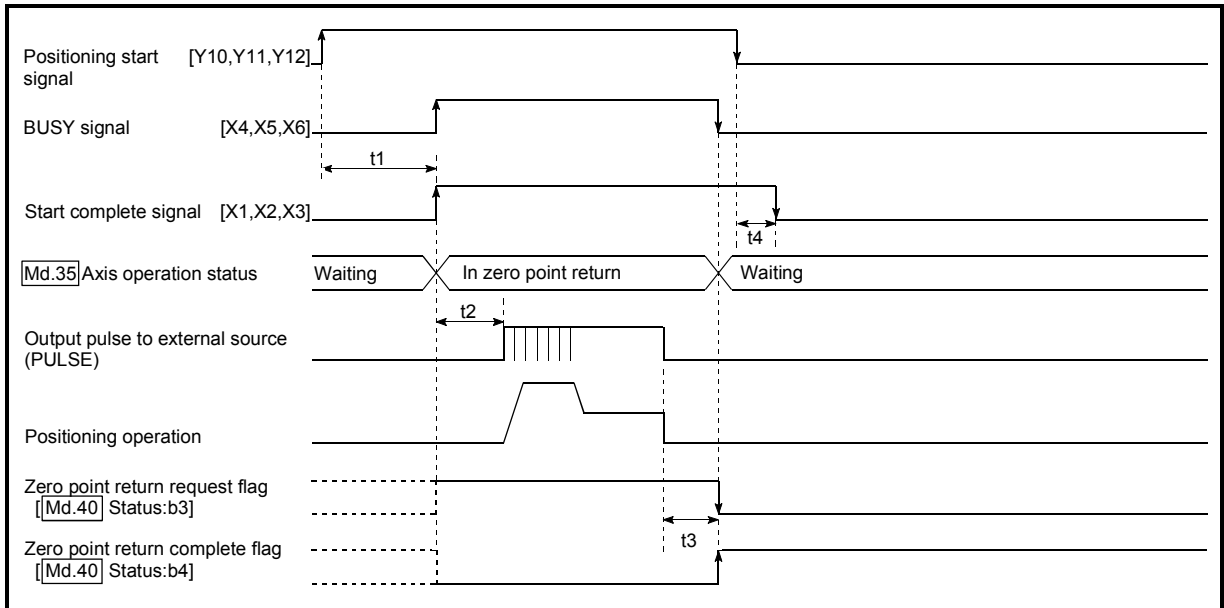

Fig. 6.8 Machine zero point return operation timing and process time

Normal timing time Unit: ms

t1	t2	t3	t4
5 to 15	0 to 3.5		

- The t1 timing time could be delayed by the following factors.
 - 1) Presence of FROM/TO command execution during start process
 - 2) Operation state of other axes
 - 3) Presence of intervention from peripheral device during start process
 - 4) Details of positioning data to be started

■ Position control operation timing and process time

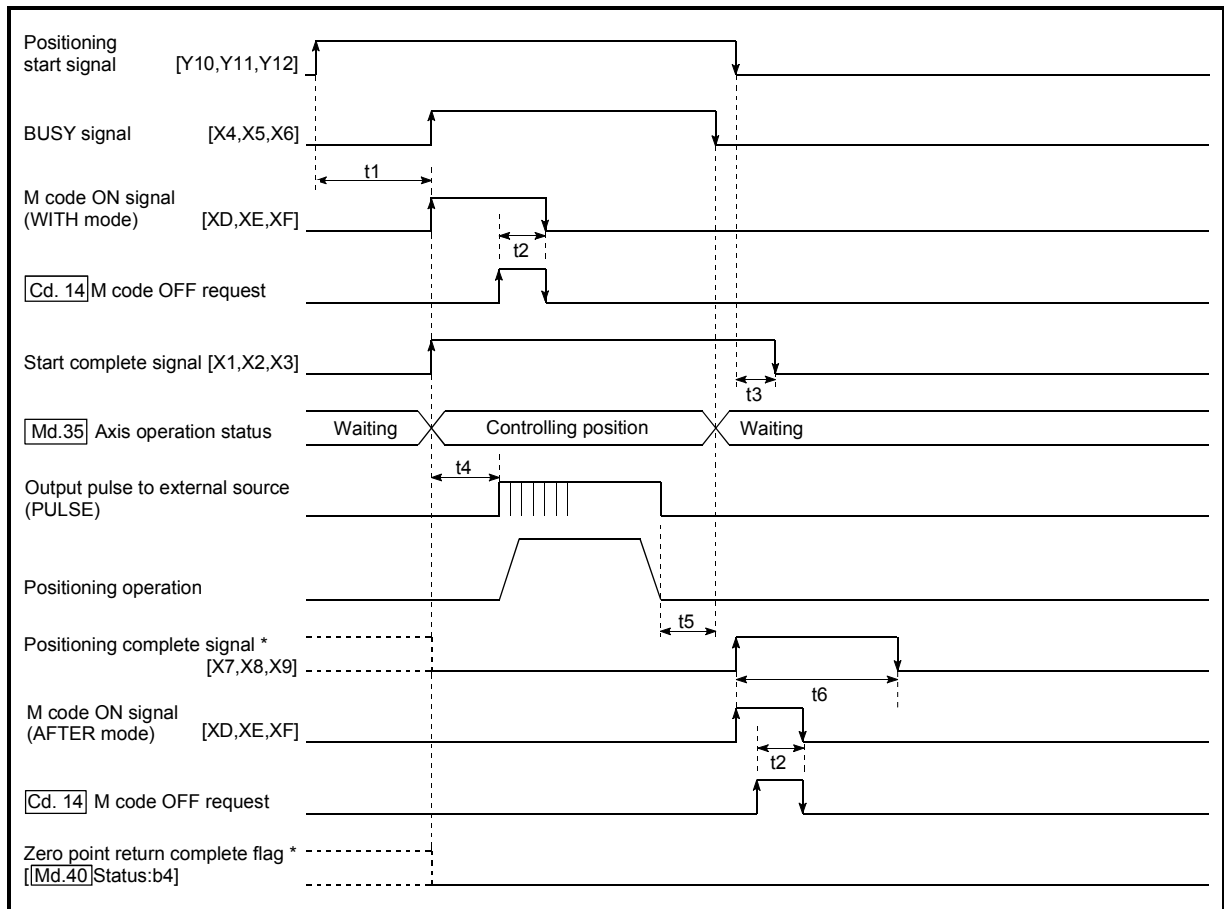

Fig. 6.9 Position control operation timing and process time

- When the positioning start signal turns ON, if all signals marked with an asterisk (*) are already ON, the signals marked with an asterisk (*) will turn OFF when the positioning start signal turns ON.

Normal timing time

Unit: ms

t1	t2	t3	t4	t5	t6
5 to 15	0 to 3.5				Follows parameters

- The t1 timing time could be delayed by the following factors.
 - 1) Presence of FROM/TO command execution during start process
 - 2) Operation state of other axes
 - 3) Presence of intervention from peripheral device during start process
 - 4) Details of positioning data to be started

(2) Starting by inputting external start signal

When starting positioning control by inputting the external start signal, the start command can be directly input into the AD75. This allows the variation time equivalent to one scan time of the PLC CPU to be eliminated. This is an effective procedure when operation is to be started as quickly as possible with the start command or when the starting variation time is to be suppressed. To start positioning control by inputting the external start signal, set the "data required to be set" and then turn ON the external start signal.

■ Restrictions

When starting by inputting the external start signal, the start complete signal [X1, X2, X3] will not turn ON.

■ Data required to be set

To execute positioning start with the external start signal, set parameter (Pr.43) beforehand, and validate the "external start signal" with the "external start function valid setting program (program No. 5).

Setting item	Setting value	Setting details	Buffer memory address		
			Axis 1	Axis 2	Axis 3
Pr.43 External start function selection	0	Set to "0: External positioning start".	62	212	362
Cd.25 External start valid	1	Set to "1: Validate external start".	1171	1221	1271

* Refer to Chapter "5 DATA USED FOR POSITIONING CONTROL" for details on the setting details.

■ Starting time chart

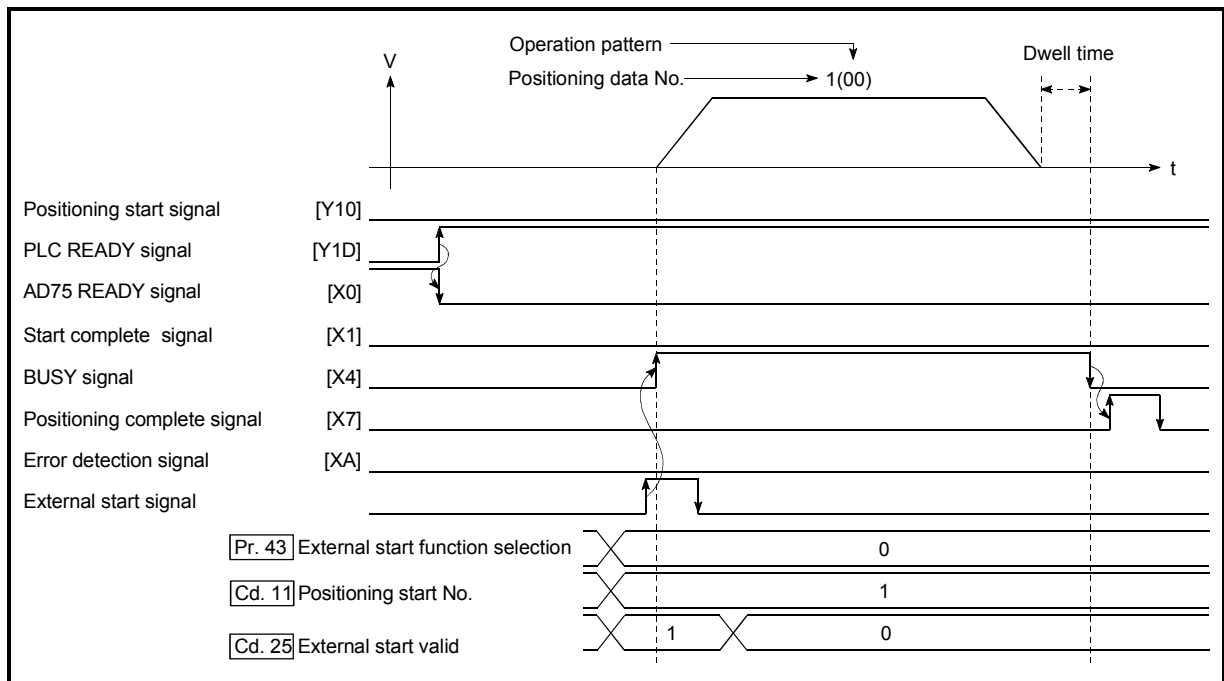

Fig. 6.10 Time chart for starting with external start signal

6.5.4 Continuous operation interrupt program

During positioning control, the control can be interrupted during continuous positioning control and continuous path control (continuous operation interrupt function). When "continuous operation interruption" is execution, the control will stop when the operation of the positioning data being executed ends. To execute continuous operation interruption, set "1: Continuous operation interrupt request" for "[Cd.32] Interrupt request during continuous operation.

(1) Operation during continuous operation interruption

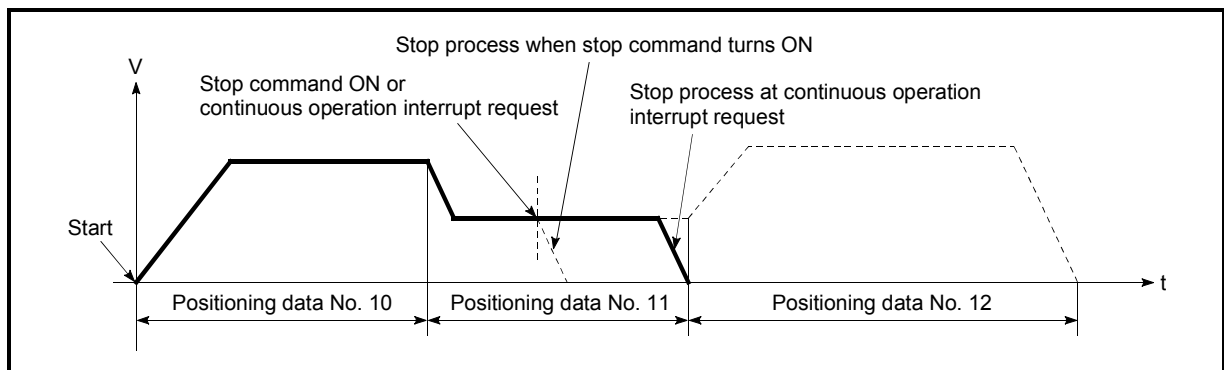
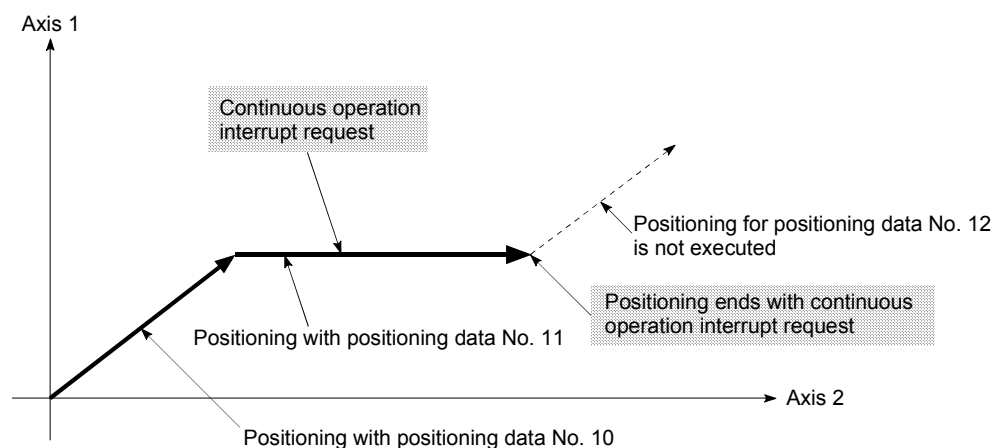

Fig. 6.11 Operation during continuous operation interruption

(2) Restrictions

- (1) When the "continuous operation interrupt request" is executed, the positioning will end.
Thus, after stopping, the operation cannot be "restarted".
When "[Cd.13] Restart command" is issued, a warning "Restart not possible" (warning code:104) will occur.
- (2) Even if the stop command is turned ON after executing the "continuous operation interrupt request", the "continuous operation interrupt request" cannot be canceled.
Thus, if "restart" is executed after stopping by turning the stop command ON, the operation will stop when the positioning data No. where "continuous operation interrupt request" was executed is completed.



- (3) If the operation cannot be decelerated to a stop because the remaining distance is insufficient when "continuous operation interrupt request" is executed with continuous path control, the interruption of the continuous operation will be postponed until the positioning data shown below.
- Positioning data No. have sufficient remaining distance
 - Positioning data No. for positioning complete (pattern: 00)
 - Positioning data No. for continuous positioning control (pattern: 01)
- (4) When operation is not performed (BUSY signals [X4, X5, X6] are OFF), the continuous operation interrupt request is not accepted. It is cleared to zero at a start or at a restart.

Even when the continuous operation interrupt is requested, the remaining distance is insufficient, and thus, the operation cannot stop at the positioning No. being executed.

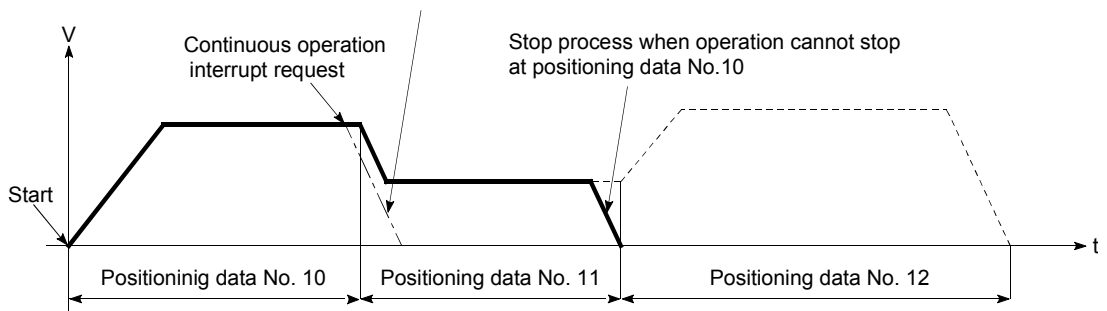

(3) Control data requiring settings

Set the following data to interrupt continuous operation.

Setting item	Setting value	Setting details	Buffer memory address		
			Axis 1	Axis 2	Axis 3
Cd.32 Interrupt request during continuous operation	1	Set "1: Interrupt request during continuous operation".	1181	1231	1281

* Refer to section "5.7 List of control data" for details on the setting details.

6.5.5 Restart program

When a stop factor occurs during position control and the operation stops, the positioning can be restarted from the stopped position to the position control end point by using the "restart command" (**[Cd.13]** Restart command).
("Restarting" is not possible when "continuous operation is interrupted.")

(1) Restart operation

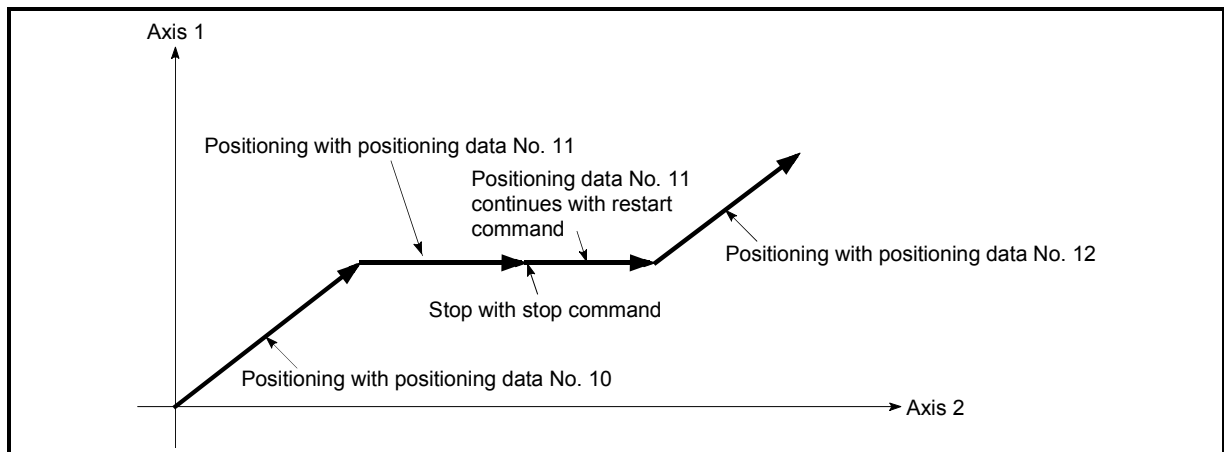

Fig. 6.12 Restart operation

(2) Restrictions

- (1) Restarting can be executed only when the "**[Md.35]** Axis operation status" is "stopped".
If the axis operation is not "stopped", restarting is not possible.
- (2) Do not execute restart while the stop command is ON.
If restart is executed while stopped, an error "Stop signal ON at start" (error code:106) will occur, and the "**[Md.35]** Axis operation status" will change to "error occurring".
Thus, even if the error is reset, the operation cannot be restarted.
- (3) Restarting can be executed even while the positioning start signal is ON.
However, make sure that the positioning start signal does not change from OFF to ON while stopped.
If the positioning start signal changes from OFF to ON, positioning will start from the positioning data No. of designated point's positioning data No. set in "**[Cd.11]** Positioning start No.".
- (4) If positioning is ended with the continuous operation interrupt request, the operation cannot be restarted.
If restart is requested, a warning "Restart not possible" (warning code:104) will occur.
- (5) When stopped with interpolation operation, write "1: restarts" into "**[Cd.13]** Restart command" for the reference axis, and then restart.
- (6) If the "**[Md.35]** Axis operation status" is not "stopped" when restarting, a multiple start warning will occur, and the process at that time will be continued.

REMARK

Restarting after stopping is possible even for the following control.

- Incremental type position control
- Continuous positioning control
- Continuous path control
- Block start

(3) Control data requiring setting

Set the following data to execute restart.

Setting item	Setting value	Setting details	Buffer memory address		
			Axis 1	Axis 2	Axis 3
Cd.13 Restart command	1	Set "1: restarts".	1152	1202	1252

* Refer to section "5.7 List of control data" for details on the setting details.

(4) Starting conditions

The following conditions must be satisfied when restarting. (Assemble the required conditions into the sequence program as an interlock.)

(1) Operation state

"Md.35 Axis operation status" is "1: Stopped"

(2) Signal state

Signal name	Signal state	Device				
		Axis 1	Axis 2	Axis 3		
Interface signal	PLC READY signal	ON	PLC CPU preparation completed	Y1D		
	AD75 READY signal	OFF	AD75 preparation completed	X0		
	Axis stop signal	OFF	Axis stop signal is OFF	Y13	Y14	Y1C
	Start complete signal	OFF	Start complete signal is OFF	X1	X2	X3
	BUSY signal	OFF	BUSY signal is OFF	X4	X5	X6
	Error detection signal	OFF	There is no error	XA	XB	XC
	M code ON signal	OFF	M code ON signal is OFF	XD	XE	XF
External signal	Drive unit READY signal	ON	Drive unit preparation completed	-		
	Stop signal	OFF	Stop signal is OFF	-		
	Upper limit (FLS)	ON	Within limit range	-		
	Lower limit (RLS)	ON	Within limit range	-		

(5) Time chart for restarting

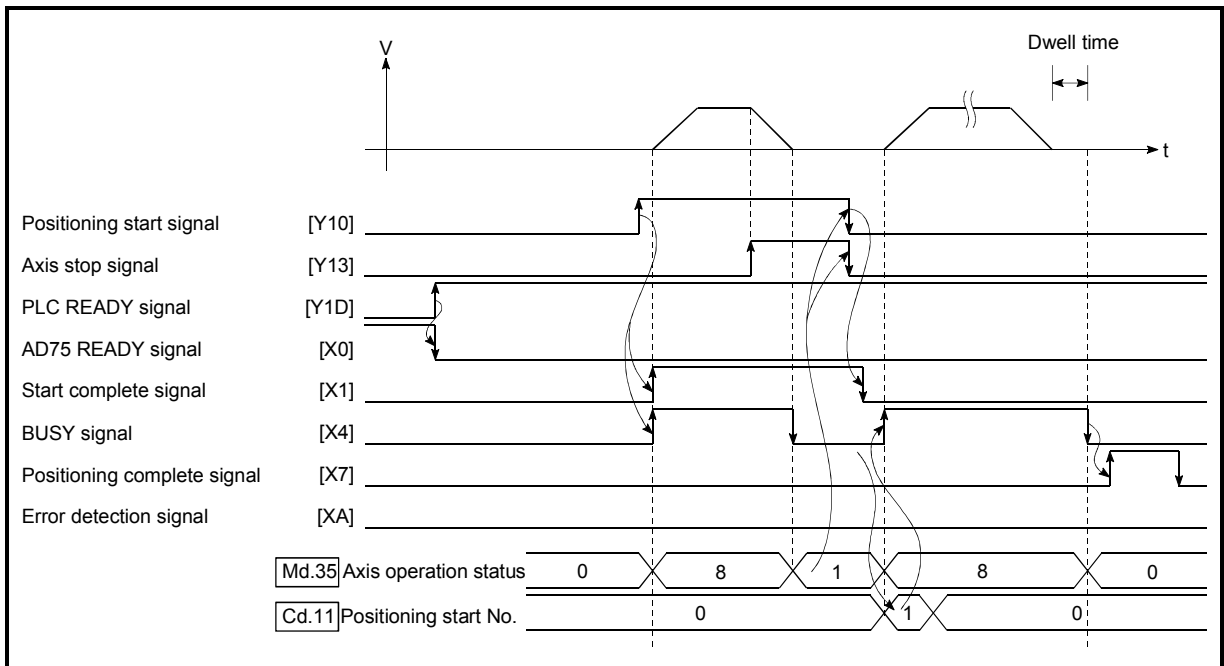

Fig. 6.13 Time chart for restarting

6.5.6 Stop program

The axis stop signal [Y13, Y14, Y1C] or a stop signal from an external source is used to stop the control. Create a program to turn the axis stop signal [Y13, Y14, Y1C] ON as the stop program.

The process for stopping control is explained below.
Each control is stopped in the following cases.

- (a) When each control is completed normally.
- (b) When the drive unit READY signal is turned OFF.
- (c) When the PLC READY signal is turned OFF. (When "parameter error" or "watch dog timer error" occurs in PLC CPU.)
- (d) When an error occurs.
- (e) When control is intentionally stopped. (Stop signal from PLC CPU turned ON, stop from peripheral device, etc.)

The stop process for the above cases is shown below. (Excluding (a) when the operation stops normally.)

(1) Stop process

Stop cause		Stop axis	Axis operation status ([Md.35]) after stopping	Stop process					
				Zero point return control		Main positioning control	Advanced positioning control	Manual control	
				Machine zero point return control	High-speed zero point return control			JOG operation	Manual pulse generator operation
Forced stop	Drive unit READY signal OFF	Each axis	During error	Immediate stop				Immediate stop	
Fatal stop (Stop group 1)	Hardware stroke limit upper/lower limit error occurrence	Each axis	During error	Deceleration stop/sudden stop (Select with [Pr.38])				Deceleration stop	
Emergency stop (Stop group 2)	Software stroke limit upper/lower limit error occurrence	Each axis	During error	Deceleration stop/sudden stop (Select with [Pr.39])				Deceleration stop	
	PLC READY signal OFF "Stop" input from external device	All axes							
Relatively safe stop (Stop group 3)	Axis error detection (Error other than stop group 1 or 2) Error in test mode	Each axis	During error	Deceleration stop/sudden stop (Select with [Pr.40])				Deceleration stop	
Intentional stop (Stop group 3)	"Stop signal" ON from external source "Axis stop signal" ON from PLC CPU	Each axis	When stopped (While waiting)						

(2) Types of stop processes

The operation can be stopped with deceleration stop, sudden stop or immediate stop.

(1) Deceleration stop

The operation stops with "deceleration time 0 to 3" (, , ,)

Which time from "deceleration time 0 to 3" to use for control is set in positioning data ()

(2) Sudden stop

The operation stops with " Sudden stop deceleration time".

(3) Immediate stop

The operation does not decelerate.

The AD75 immediately stops the pulse output, but the operation will coast for the droop pulses accumulated in the drive unit's deviation counter.

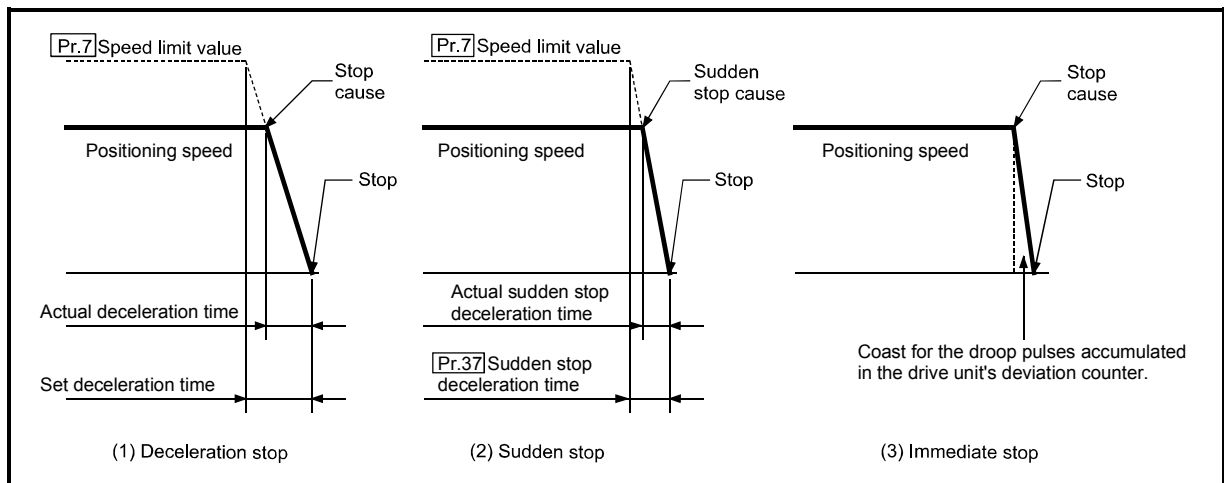

Fig. 6.14 Types of stop processes

REMARK

- *1 "Deceleration stop" and "sudden stop" are selected with the details parameter "stop group 1 to 3 sudden stop selection". (The default setting is "deceleration stop".)

(3) Order of priority for stop process

The order of priority for the AD75 stop process is as follows.

Deceleration stop < Sudden stop < Immediate stop

- (1) During deceleration (including automatic deceleration), the operation will stop at that deceleration speed even if the decelerations to command turns ON (stop signal turns ON) or a deceleration stop cause occurs.
- (2) If the stop signal designated for sudden stop turns ON or a stop cause occurs during deceleration, the sudden stop process will start from that point. However, if the sudden stop deceleration time is longer than the deceleration time, the deceleration stop process will be continued even if a sudden stop cause occurs during the deceleration stop process.

Example

The process when a sudden stop cause occurs during deceleration stop is shown below.

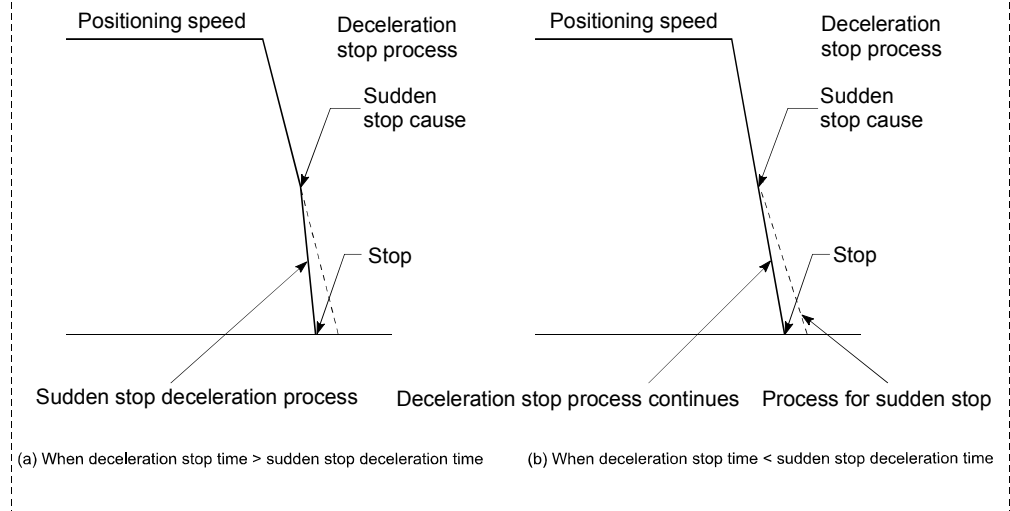

Chapter 7

MEMORY CONFIGURATION AND DATA PROCESS

The AD75 memory configuration and data transmission are explained in this chapter.

The AD75 is configured of three memories. By understanding the configuration and roles of these memories, the AD75 internal data transmission process, such as "when the power is turned ON" or "when the PLC READY signal changes from OFF to ON" can be easily understood. This also allows the transmission process to be carried out correctly when storage or changing the data.

7.1	Configuration and roles of AD75 memory	7- 2
7.1.1	Configuration and roles of AD75 memory.....	7- 2
7.1.2	Buffer memory area configuration.....	7- 5
7.2	Data transmission process.....	7- 6

7.1 Configuration and roles of AD75 memory

7.1.1 Configuration and roles of AD75 memory

The AD75 is configured of the following three memories.

Memory configuration	Role	Area configuration									Backup
		Parameter area	Positioning data area (No.1 to 100)	Positioning data area (No.101 to 600)	Positioning start information area (No.7000)	Positioning start information area (No.7001 to 7010)	Monitor data area	Control data area	PLC CPU memo area	Block transmission area	
• Buffer memory	Area that can be directly accessed with sequence program from PLC CPU.	○	○	-	○	-	○	○	○	○	Not possible
• Flash ROM	Area for backing up data required for positioning.	○	○	○	○	○	-	-	-	-	Possible
• OS memory	Area used by system.	○	○	○	○	○	-	-	-	-	Not possible

○ : Setting and storage area provided, Not possible: Data is lost when power is turned OFF

- : Setting and storage area not provided, Possible: Data is held even when power is turned OFF

■ Details of areas

- Parameter area
Area where parameters, such as positioning parameters and zero point return parameters, required for positioning control are set and stored.
(Set the items indicated with Pr.1 to Pr.58 for each axis.)
 - Positioning data area (No.1 to 100)
Area where positioning data No.1 to 100 is set and stored.
(Set the items indicated with Da.1 to Da.9 for each positioning data.)
 - Positioning data area (No.101 to 600)
Area where positioning data No.101 to 600 is set and stored.
(Set the items indicated with Da.1 to Da.9 for each positioning data.)
 - Positioning start information area (No.7000)
Area where information required only when carrying out block No. 7000 advanced positioning is set and stored. (Set the items indicated with Da.10 to Da.18.)
 - Positioning start information area (No.7001 to 7010)
Area where information required only when carrying out block No. 7001 to 7010 advanced positioning is set and stored. (Set the items indicated with Da.10 to Da.18.)
 - Monitor data area
Area where positioning system or AD75 operation state is stored.
(Set the items indicated with Md.1 to Md.56.)
 - Control data area
Area where data for operating and controlling positioning system is set and stored. (Set the items indicated with Cd.1 to Cd.35.)
 - PLC CPU memo area
Area where condition judgment values required for special positioning, etc., are set and stored.
 - Block transmission area
Memory area used for setting the "positioning data No. 101 to 600" with sequence program.
- * When using a peripheral device, the "positioning data No. 101 to 600" is set with the same method as "positioning data No. 1 to 100".

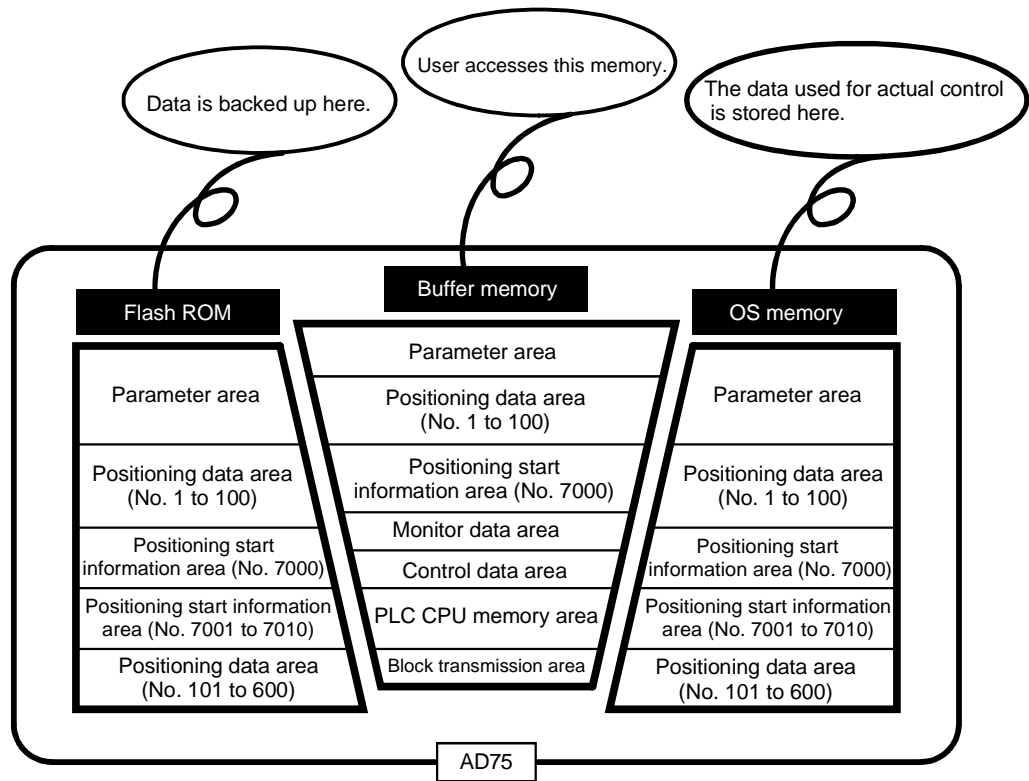

7.1.2 Buffer memory area configuration

The AD75 buffer memory is configured of the following types of areas.

Buffer memory area configuration		Buffer memory address			Writing possibility
		Axis 1	Axis 2	Axis 3	
Parameter area	Basic parameter area	0 to 14	150 to 164	300 to 314	Possible
	Detailed parameter area	15 to 66	165 to 216	315 to 366	
	Zero point return basic parameter area	70 to 78	220 to 228	370 to 378	
	Zero point return detailed parameter area	79 to 89	229 to 239	379 to 389	
Monitor data area	System monitor area	450 to 799			Not possible
	Axis monitor area	800 to 899	900 to 999	1000 to 1099	
Control data area	System control data area	1100 to 1149			Possible
	Axis control data area	1150 to 1199	1200 to 1249	1250 to 1299	
Positioning data area (No.1 to 100)	Positioning data area	1300 to 2299	2300 to 3299	3300 to 4299	Possible
Positioning start information area (No.7000)	Start block data area	4300 to 4349	4550 to 4599	4800 to 4849	
		4350 to 4399	4600 to 4649	4850 to 4899	
	Condition data area	4400 to 4499	4650 to 4749	4900 to 4999	
	Indirectly specification data area	4500 to 4549	4750 to 4799	5000 to 5049	
PLC CPU memo area	PLC CPU memo area	5050 to 5099			Possible
Block transmission area	Block transmission area	5100 to 6109			Possible

* Use of address Nos. skipped above is prohibited. If used, the system may not operate correctly.
(For details of the buffer memory address, refer to Appendix 12.)

7.2 Data transmission process

The data is transmitted between the AD75 memories with steps (1) to (10) shown below.

- The data transmission patterns numbered (1) to (10) on the right page correspond to the numbers (1) to (10) on the left page.

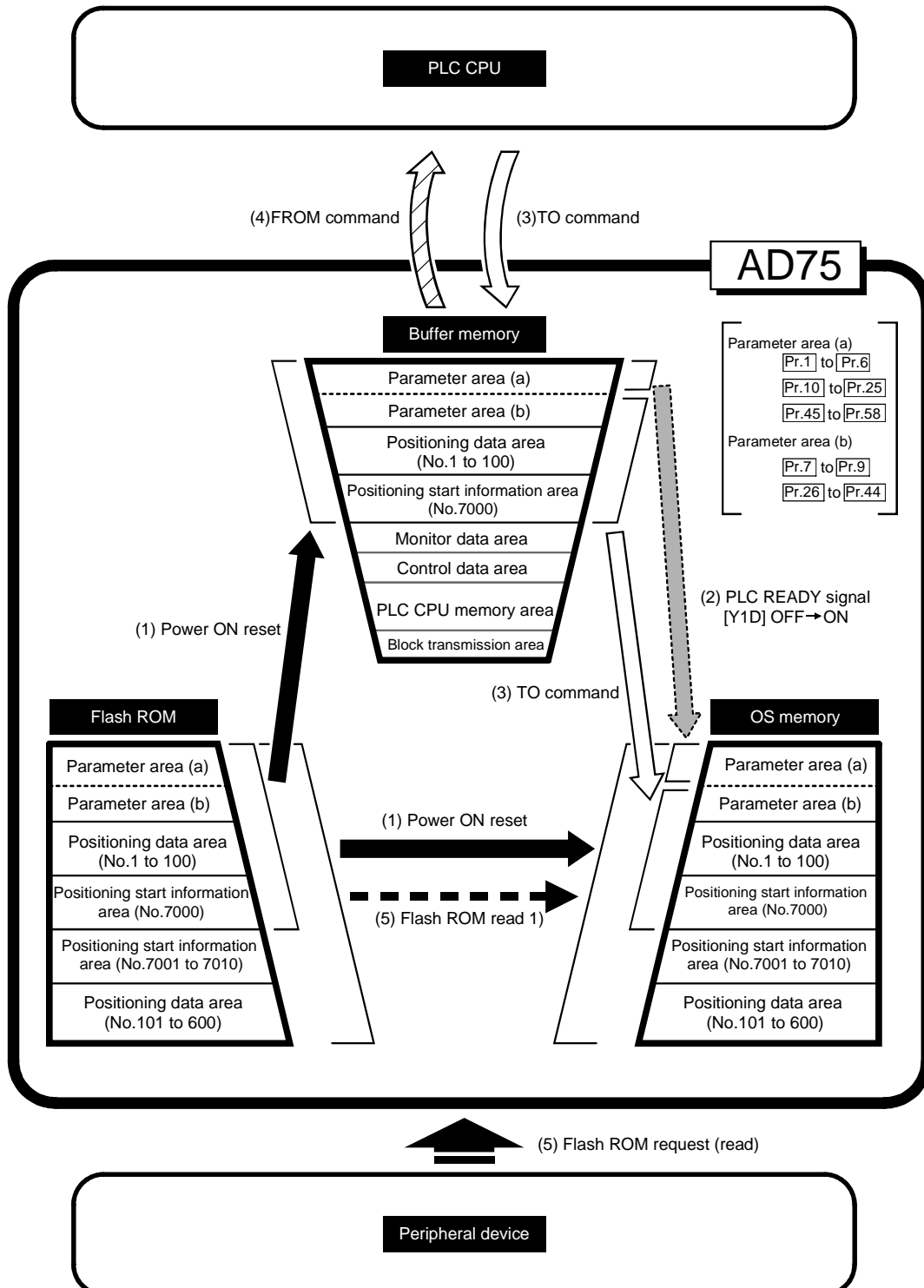

- (1) Transmitting data when power is turned ON or PLC CPU is reset ()

When the power is turned ON or the PLC CPU is reset, the "parameters", "positioning data" and "positioning start information" stored (backed up) in the flash ROM is transmitted to the buffer memory and OS memory.

(The "positioning data (No. 101 to 600)" and "positioning start information (No. 7001 to 7010)" data is not transmitted to the buffer memory.)

- (2) Transmitting data when PLC READY signal [Y1D] changes from OFF to ON ()

When the PLC READY signal [Y1D] changes from OFF to ON, the data stored in the buffer memory's "parameter area (a) *1" is transmitted to the OS memory.

*1 Parameter area (a) Parameters transmitted to OS memory when PLC READY signal [Y1D] changes from OFF to ON
(Pr.1 to Pr.6, Pr.10 to Pr.25, Pr.45 to Pr.58)

- (3) Transmitting data with TO command from PLC CPU ()

The parameters or data is written from the PLC CPU to the buffer memory using the TO command. At this time, when the "parameter area (b) *2", "positioning data (No. 1 to 100)" and "positioning start information (No. 7000)" is written into the buffer memory with the TO command, it is simultaneously transmitted to the OS memory.

*2 Parameter area (b) Parameters transmitted to the OS memory simultaneously with the writing to the buffer memory with the TO command. (Pr.7 to Pr.9, Pr.26 to Pr.44)

POINT
The setting values of the parameters that correspond to parameter area (b) are valid when written into the buffer memory with the TO command. However, the setting values of the parameters that correspond to parameter area (a) are not validated until the PLC READY signal [Y1D] changes from OFF to ON.

- (4) Accessing with FROM command from PLC CPU ()

The data is read from the buffer memory to the PLC CPU using the FROM command.

- (5) Flash ROM request (reading) ()

The following transmission process is carried out with the "flash ROM request" from the peripheral device.

- 1) The "parameters", "positioning data (No. 1 to 600)", and "positioning start information (No. 7000 to 7010)" in the flash ROM is transmitted to the OS memory.

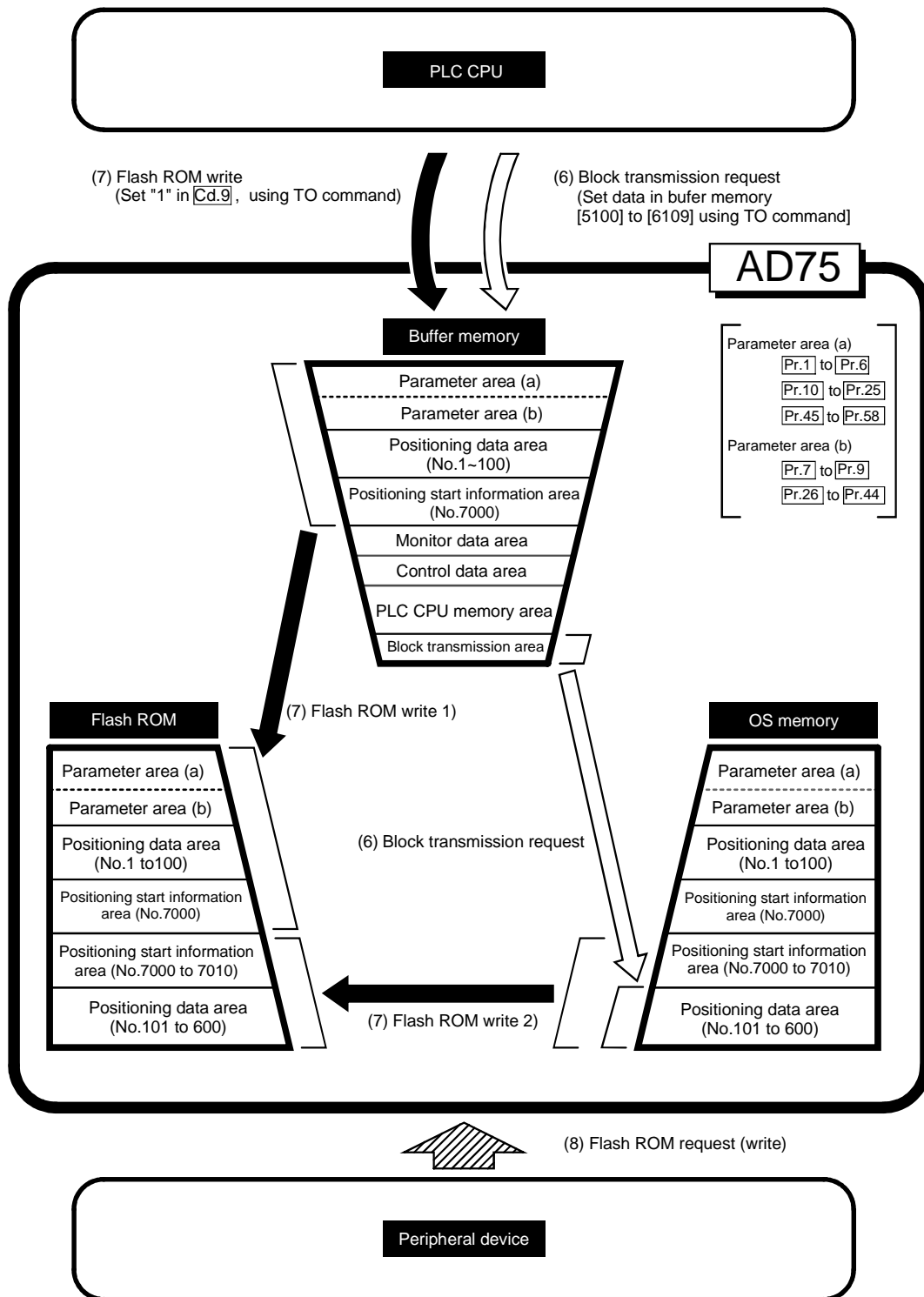

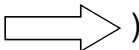
(6) Transmitting blocks from PLC CPU ()

When setting data in positioning data No. 101 to 600 using the sequence program, first the data is set in the "block transmission area" (buffer memory address [5100] to [6109]). Then, the data is set in positioning data No. 101 to 600 by transmitting the data to the OS memory. Refer to section "7.2 Data transmission process (B)" for the procedures.

Note 1) Block transmission from the PLC CPU can be executed only when the PLC READY signal [Y1D] is OFF.

If it is executed when the PLC READY signal [Y1D] is ON, warning "in PLC READY" (warning code: 111) will occur.

Note 2) The buffer memory does not have an area to store the positioning data No. 101 to 600, so when setting data in the positioning data No. 101 to 600 using the sequence program, the procedures and settings will be complicated. Use of the AD75 software package when setting positioning data No. 101 to 600 is recommended.

(7) Flash ROM write ()

The following transmission process is carried out by setting "1" in "Cd.9 Flash ROM write request" (buffer memory [1138]).

- 1) The "parameters", "positioning data (No. 1 to 100)" and "positioning start information (No. 7000)" in the buffer memory area are transmitted to the flash ROM.
- 2) The "positioning data (No. 101 to 600)" and "positioning start information (No. 7001 to 7010)" in the OS memory are transmitted to the flash ROM.

POINT

The following two types of parameters are stored in the buffer memory.

- Parameters transmitted to the OS memory when the PLC READY signal [Y1D] changes from OFF to ON
- Parameters transmitted simultaneously to the OS memory when written into the buffer memory with the TO command

With type 1) of the flash ROM write, the "parameters and data set in the buffer memory" (including parameters not transmitted to the OS memory) are written into the flash ROM.

(8) Flash ROM request (writing) ()

The following transmission processes are carried out with the [flash ROM request] from the peripheral device.

- 1) The "parameters", "positioning data (No. 1 to 100)" and "positioning start information (No. 7000)" in the buffer memory area are transmitted to the flash ROM.
- 2) The "positioning data (No. 101 to 600)" and "positioning start information (No. 7001 to 7010)" in the OS memory are transmitted to the flash ROM.

Note) This transmission process is the same as (7) above.

IMPORTANT

Do not turn the power OFF or reset the PLC CPU while writing to the flash ROM. If the power is turned OFF or the PLC CPU is reset to forcibly end the process, the data backed up in the flash ROM will be lost.

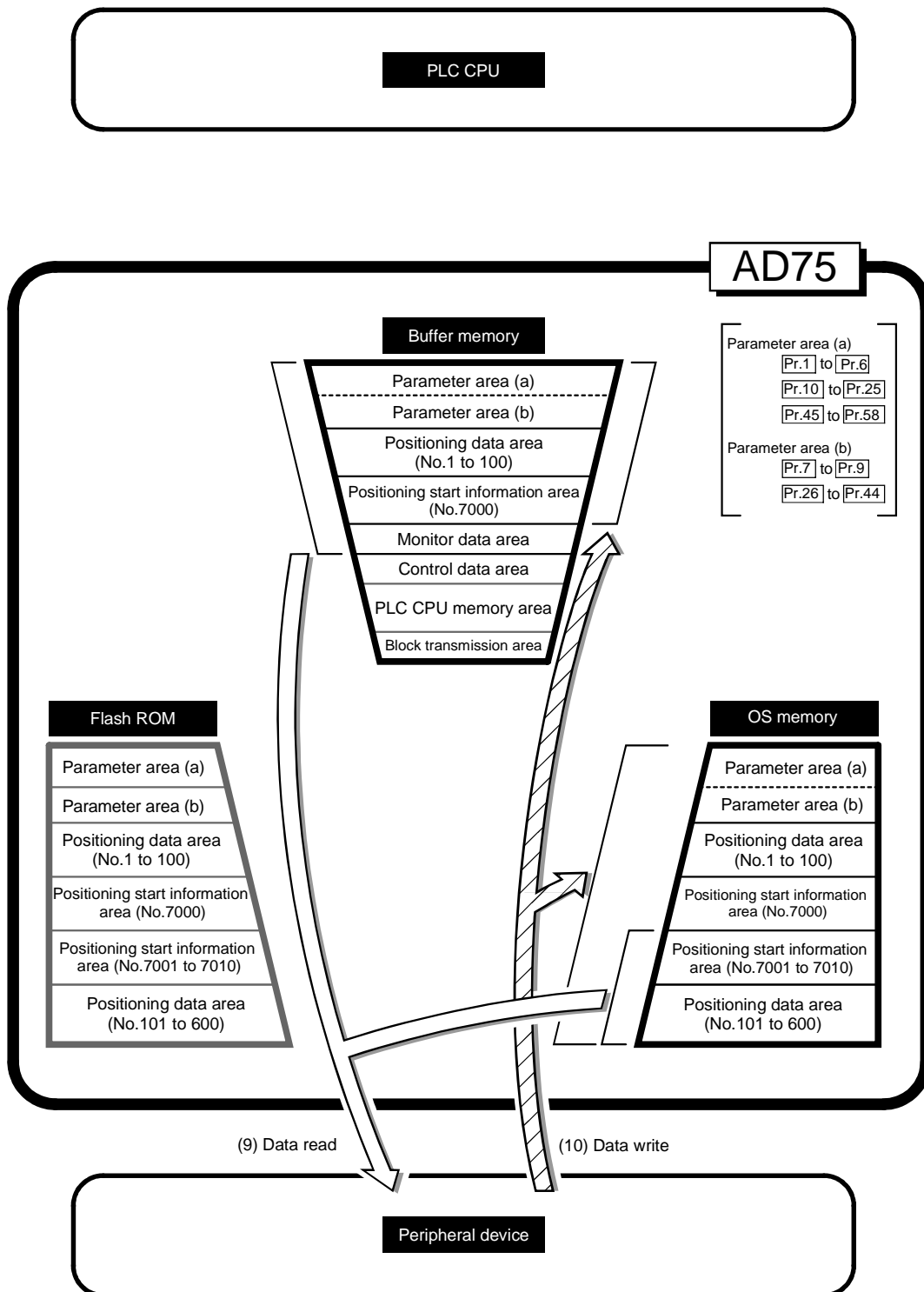

(9) Reading data from buffer memory or OS memory to peripheral device ()

The following transmission processes are carried out with the [AD75 read] from the peripheral device.

- 1) The "parameters", "positioning data (No. 1 to 100)" and "positioning start information (No. 7000)" in the buffer memory area are transmitted to the peripheral device.
- 2) The "positioning data (No. 101 to 600)" and "positioning start information (No. 7001 to 7010)" in the OS memory are transmitted to the peripheral device.

(10) Writing data from peripheral device to buffer memory or OS memory ()

The following transmission processes are carried out with the [AD75 write] from the peripheral device.

- 1) The "parameters", "positioning data (No. 1 to 100)" and "positioning start information (No. 7000)" in the peripheral device area transmitted to the buffer memory.
- 2) The "positioning data (No. 101 to 600)" and "positioning start information (No. 7001 to 7010)" in the peripheral device are transmitted to the OS memory.

At this time, when [Flash ROM Write] is set with the peripheral device, the transmission processes indicated with the following are carried out.

- (7) Flash ROM write 1
- (7) Flash ROM write 2

The data transmission is carried out as shown in the previous pages, but the main method of using this data process is shown below.

(A) Correcting the execution data (OS memory)

The following methods can be used to correct the OS memory.

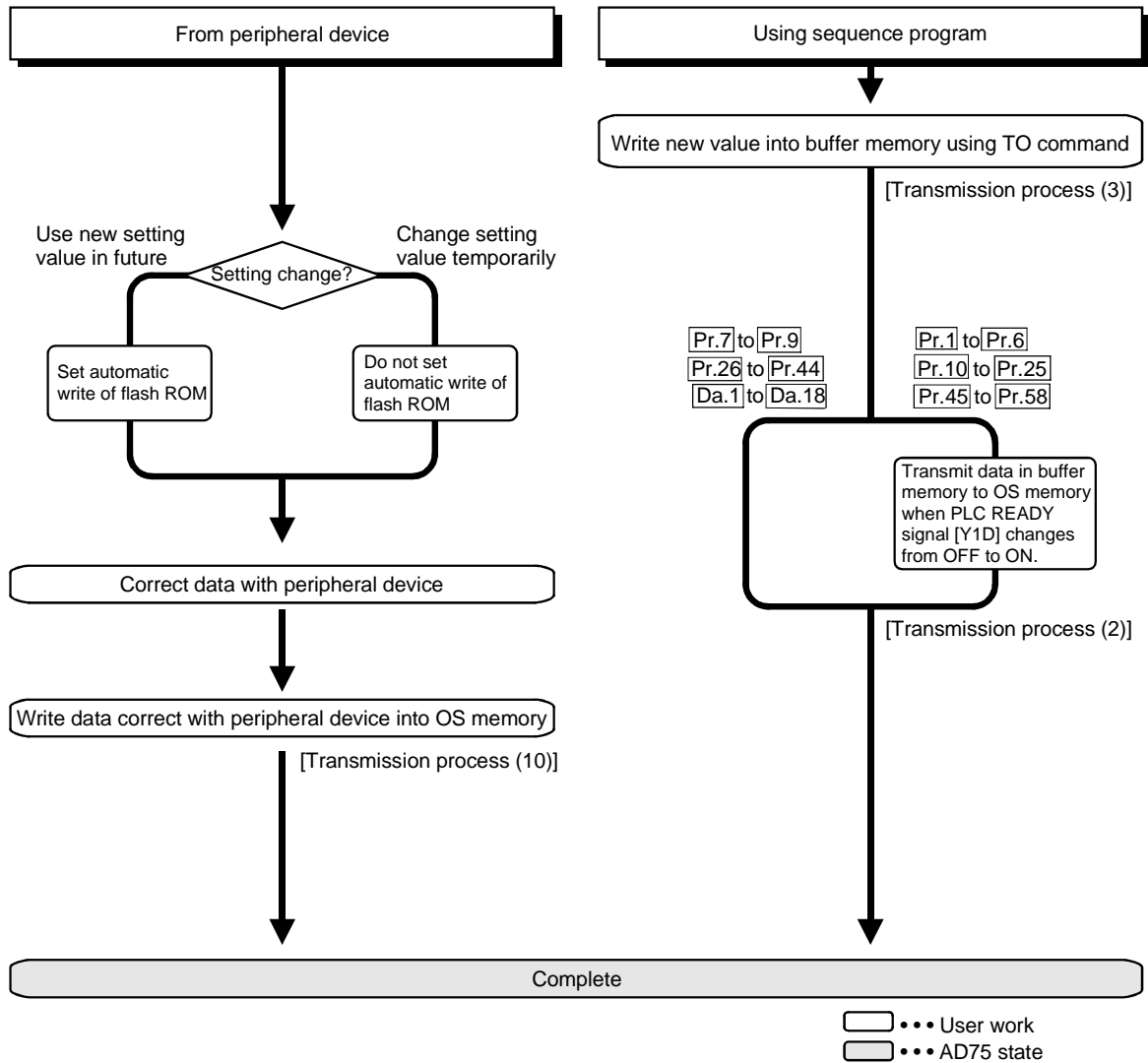

(B) Setting positioning data No. 101 to 600 data

The positioning data is set with the following procedures.

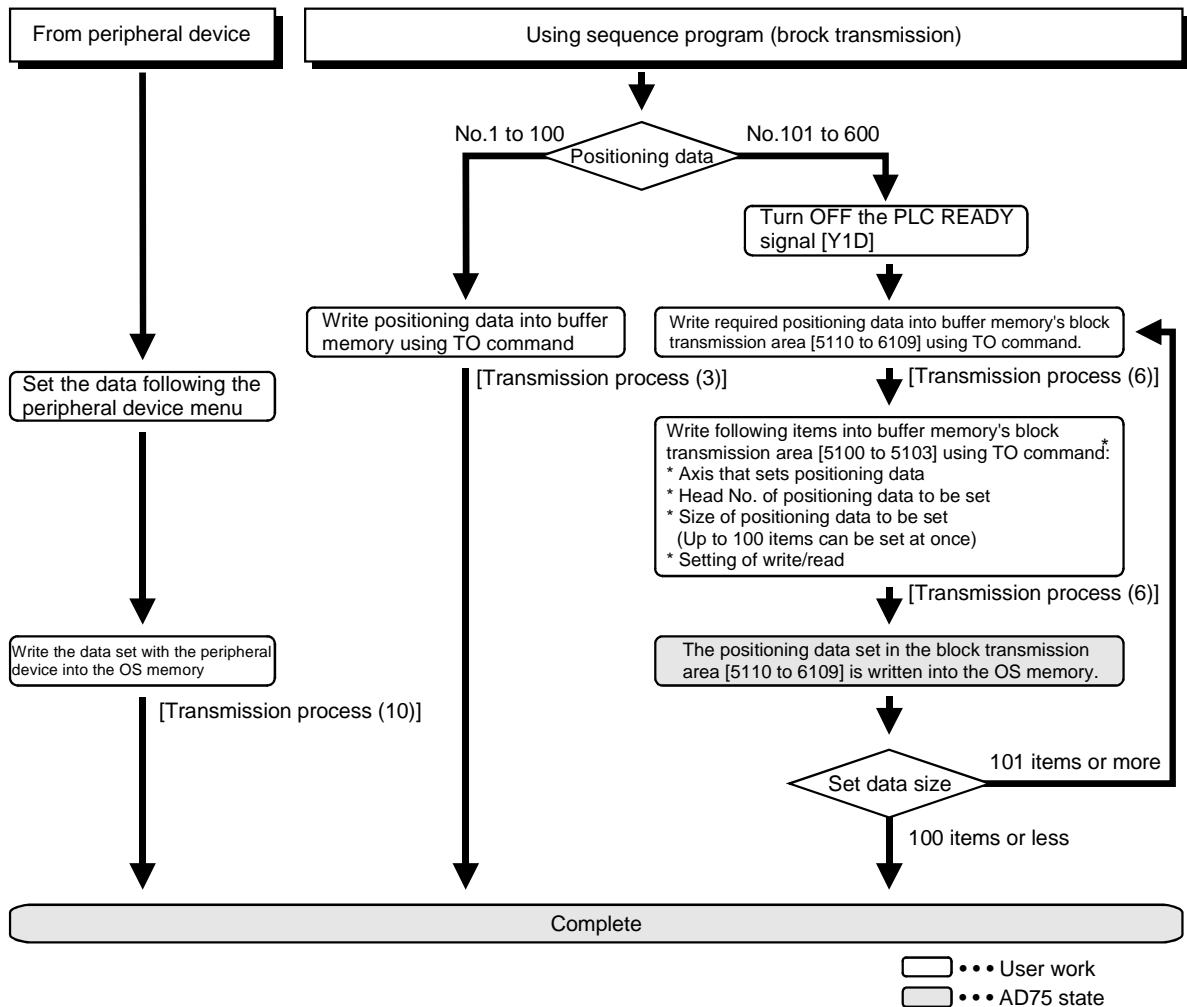

* The details written with the TO command are shown below.

Block transmission memory	5100	Target axis (1: axis 1, 2: axis 2, 3: axis 3)
	5101	Head positioning data No. (1 to 600)
	5102	No. of read/write data (1 to 100)
	5103	Read/write request 0: Read/write complete (set by OS) 1: Read request 2: Write request
	5110 to 6109	Read/write block (Positioning data storage area)

- Which axis
- From nth positioning data in OS memory
- How many data
- Whether to read or write
- When reading, the data is read from the OS memory into here, and when writing, the data set and stored here is written into the OS memory.

* The default value is "0".

(Example) When setting the positioning data No. 101 to 300 of axis 1 to the OS memory
 (The number of data that can be set for block transmission at one time is up to 100 pieces.)

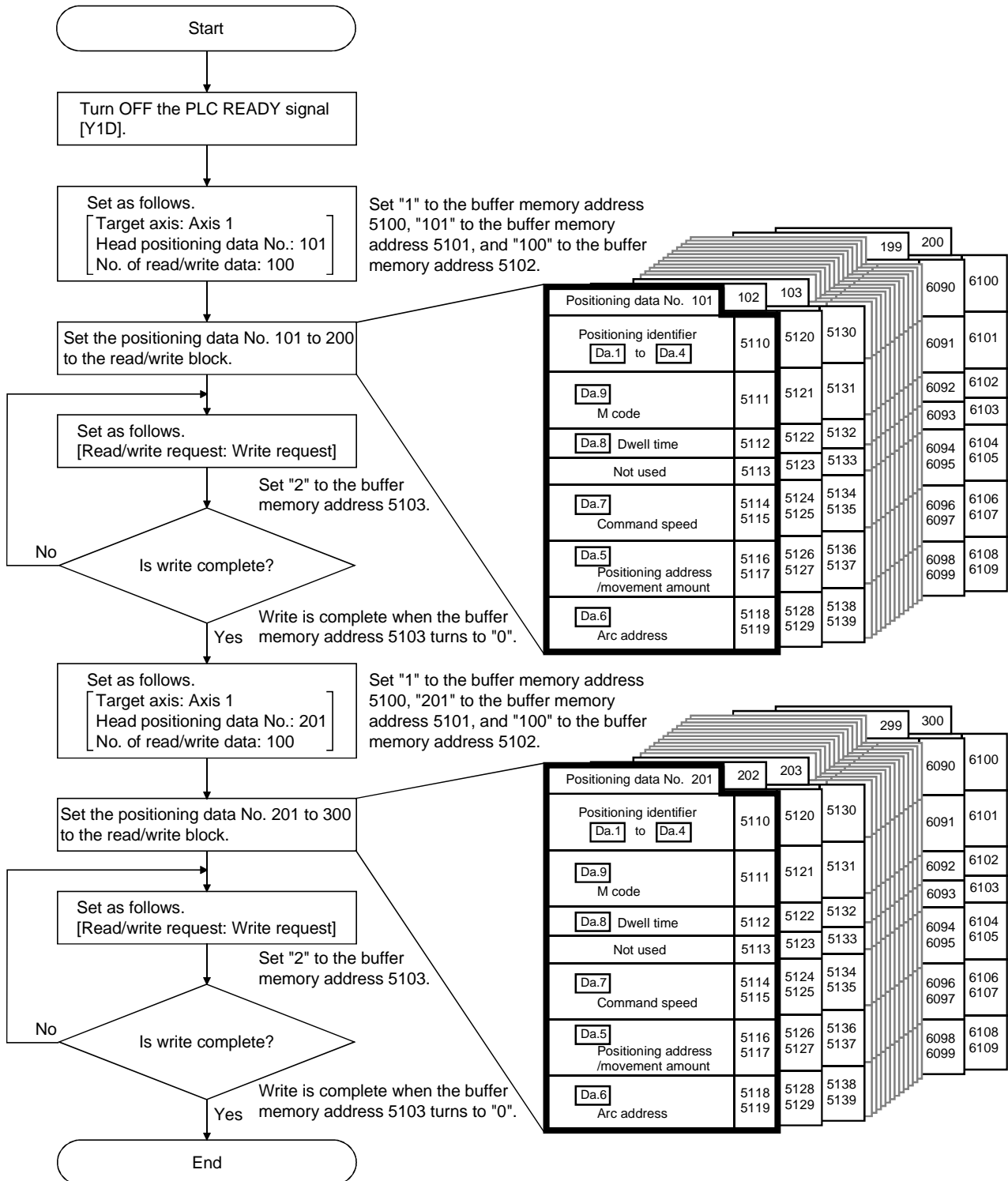

SECTION 2

CONTROL DETAILS AND SETTING

SECTION 2 is configured for the following purposes shown in (1) to (3).

- (1) Understanding of the operation and restrictions of each control.
- (2) Carrying out the required settings in each control
- (3) Dealing with errors

The required settings in each control include parameter setting, positioning data setting, control data setting by a sequence program, etc.

Carry out these settings while referring to "Chapter 5 DATA USED FOR POSITIONING CONTROL".

Also refer to "Chapter 6 SEQUENCE PROGRAM USED IN POSITIONING CONTROL" when creating the sequence programs required in each control, and consider the entire control program configuration when creating each program.

Chapter 8	ZERO POINT RETURN CONTROL	8- 1 to 8- 26
Chapter 9	MAIN POSITIONING CONTROL	9- 1 to 9- 62
Chapter 10	ADVANCED POSITIONING CONTROL	10- 1 to 10- 24
Chapter 11	MANUAL CONTROL	11- 1 to 11- 26
Chapter 12	CONTROL AUXILIARY FUNCTIONS	12- 1 to 12- 86
Chapter 13	COMMON FUNCTIONS	13- 1 to 13- 12
Chapter 14	TROUBLESHOOTING	14- 1 to 14- 36

Chapter 8

ZERO POINT RETURN CONTROL

The details and usage of "zero point return control" are explained in this chapter.

Zero point return control includes "machine zero point returns" that establish a machine zero point without using address data, and "high-speed zero point returns" that store the coordinates established by the machine zero point return, and carry out positioning to that position.

Zero point returns carried out by sequence programs from the PLC CPU are explained in this chapter.

Refer to the AD75 Software Package Operating Manual for details on zero point returns using the AD75 software package.

8.1	Outline of zero point return control.....	8- 2
8.1.1	Two types of zero point return control.....	8- 2
8.2	Machine zero point return	8- 4
8.2.1	Outline of the machine zero point return operation	8- 4
8.2.2	Machine zero point return method	8- 5
8.2.3	Zero point return method (1): Near-point dog method	8- 6
8.2.4	Zero point return method (2): Stopper stop method 1).....	8- 8
8.2.5	Zero point return method (3): Stopper stop method 2).....	8- 11
8.2.6	Zero point return method (4): Stopper stop method 3).....	8- 14
8.2.7	Zero point return method (5): Count method 1).....	8- 16
8.2.8	Zero point return method (6): Count method 2).....	8- 18
8.3	High-speed zero point return	8- 20
8.3.1	Outline of the high-speed zero point return operation	8- 20
8.4	Positioning to the zero point.....	8- 22

8.1 Outline of zero point return control

8.1.1 Two types of zero point return control

In "zero point return control" a position is established as the starting point (or "zero point") when carrying out positioning control, and positioning is carried out toward that starting point.

It is used to return a machine system at any position other than the zero point to the zero point, such as, when the AD75 issues a "zero point return request"*, after a positioning stop, etc.

In the AD75, the two types of controls shown below are defined as "zero point return control", following the flow of the zero point return work.

These two types of zero point return control can be executed by setting the "zero point return parameters", setting "Positioning start No. 9001" and "Positioning start No. 9002" prepared beforehand in the AD75 to "Cd.11 Positioning start No.", and turning ON the positioning start signal.

- (1) Establish a positioning control zero point
 - "Machine zero point return" (positioning start No. 9001)
- (2) Carry out positioning toward the zero point
 - "High-speed zero point return" (positioning start No. 9002).

* The "machine zero point return" in (1) above must always be carried out before executing the "high-speed zero point return" in (2).

REMARK

Zero point return request *

The "zero point return request flag" (Md.40 Status : b3) must be turned ON in the AD75, and a machine point return must be executed in the following cases.

- When the power is turned ON
- At the ON → OFF of the drive unit READY signal (Md.39 External input/output signal: b0).
- At the OFF → ON of the PLC READY signal [Y1D]

The address information stored in the AD75 cannot be guaranteed while the "zero point return request flag" is ON.

The "zero point return request flag" turns OFF and the "zero point return complete flag" (Md.40 Status: b4) turns ON if the machine zero point return is executed and is completed normally.

■ Zero point return auxiliary functions

Refer to section "3.3.4 Combination of AD75 main functions and auxiliary functions" for details on "auxiliary functions" that can be combined with zero point return control. Also refer to "Chapter 12 CONTROL AUXILIARY FUNCTIONS" for details on each auxiliary function.

[Remarks]

The following two auxiliary functions are only related to machine zero point returns.

Auxiliary function name	Machine zero point return	High-speed zero point return	Reference
Zero point return retry function	△	×	Section 12.2.1
Zero point shift function	○	×	Section 12.2.2

○ : Combination possible, △: Restricted, ×: Combination not possible

■ When a zero point return is not required

Control can be carried out ignoring the "zero point return request flag" (Md.40 Status : b3) in systems that do not require a zero point return.

In this case, the "zero point return parameters (Pr.45 to Pr.58)" must all be set to their initial values or a value at which an error does not occur.

■ Zero point returns from peripheral devices

"Machine zero point returns" and "high-speed zero point returns" can be executed from the AD75 software package test mode.

Refer to the AD75 software package operating manual for details on zero point returns from the AD75 software package.

8.2 Machine zero point return

8.2.1 Outline of the machine zero point return operation

Important

Use the zero point return retry function when the zero point position is not always in the same direction from the workpiece operation area (when the zero point is not set near the upper or lower limit of the machine).

* The machine zero point return may not complete unless the zero point return retry function is used.

■ Machine zero point return operation

In a machine zero point return, establish a machine zero point. None of the address information stored in the AD75, PLC CPU, or servo amplifier is used at this time. The position mechanically established after the machine zero point return is regarded as the "zero point" to be the starting point for positioning control.

The method for establishing a "zero point" by a machine zero point return differs according to the method set in "[Pr.45] Zero point return method". The following shows the operation when starting a machine zero point return.

1)	The machine zero point return is started.
2)	The operation starts according to the speed and direction set in the zero point return parameters ([Pr.45] to [Pr.58]).
3)	The "zero point" is established by the method set in "[Pr.45] Zero point return method", and the machine stops. (Refer to sections 8.2.2 to 8.2.8)
4)	If "a" is set in "[Pr.47] Zero point address", "a" will be stored as the current position in the "[Md.29] Current feed value" and "[Md.30] Machine feed value" which are monitoring the position.
5)	"[Pr.47] Zero point address" ("a") is stored in the "[Md.43] Zero point absolute position".
6)	The machine zero point return is completed.

* The "[Pr.47] Zero point address" is a fixed value set by the user, but the "[Md.43] Zero point absolute position" is constantly changed by the AD75 to indicate the "zero point", even if there is a change in the address information.

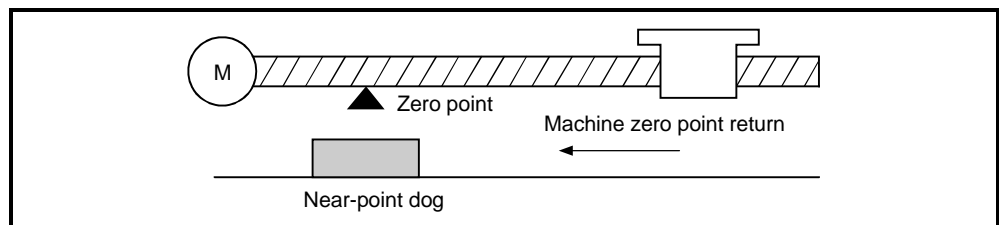

Fig. 8.1 Example of a machine zero point return

8.2.2 Machine zero point return method

The method by which the machine zero point is established (method for judging the zero point position and machine zero point return completion) is designated in the machine zero point return according to the configuration and application of the positioning method.

The following table shows the six methods that can be used for this zero point return method.

(The zero point return method is one of the items set in the zero point return parameters. It is set in "[Pr.45] Zero point return method" of the basic parameters for zero point returns.)

[Pr.45] Zero point return method	Operation details
Near-point dog method	Deceleration starts by the OFF → ON of the near-point dog. (Speed is reduced to "[Pr.49] Creep speed".) The operation stops at the first zero point signal* after the near-point dog turns from ON → OFF. When a "deviation counter clear output" is completed, the machine zero point return is completed.
Stopper method 1)	The stopper position is regarded as the zero point. After the deceleration starts by the OFF → ON of the near-point dog, the machine presses against the stopper at the "[Pr.49] Creep speed" and stops. The machine zero point return is regarded as completed on completion of the deviation counter clear output provided after "[Pr.51] Zero point return dwell time" passed after stoppage.
Stopper method 2)	The stopper position is regarded as the zero point. After the deceleration starts by the OFF → ON of the near-point dog, the machine presses against the stopper at the "[Pr.49] Creep speed" and stops. The machine zero point return is regarded as completed on completion of the deviation counter clear output provided after the zero point signal* is detected after stoppage.
Stopper method 3)	The stopper position is regarded as the zero point. The machine starts at the "[Pr.49] Creep speed" from the beginning, then presses against the stopper at the "[Pr.49] Creep speed" and stops. The machine zero point return is regarded as completed on completion of the deviation counter clear output provided after the zero point signal* is detected after stoppage.
Count method 1)	The deceleration starts by the OFF → ON of the near-point dog, and the machine moves at the "[Pr.49] Creep speed". The machine stops at the zero point signal* after moving the distance set in the "[Pr.52] Setting for the movement amount after near-point dog ON" from the near point dog OFF → ON position. When a "deviation counter clear signal output" is completed, the machine zero point return is regarded as completed.
Count method 2)	The deceleration starts by the OFF → ON of the near-point dog, and the machine moves at the "[Pr.49] Creep speed". The machine moves the distance set in the "[Pr.52] Setting for the movement amount after near-point dog ON" from the near point dog OFF → ON position, and stops at that position. The machine zero point return is then regarded as completed.

*: The zero point input signals of the AD75 in each zero point return method are described below.

Near-point dog method and count method (1): One-pulse signal output per each motor revolution (Z-phase signal output from drive unit, etc.)

Stopper stop method (2), (3): Signal output upon detection of contact with stopper (Supplied from an external device)

REMARK**Creep speed**

The stopping accuracy is poor when the machine suddenly stops from high speeds. To improve the machine's stopping accuracy, its must change over to a low speed before stopping. This speed is set in the "[Pr.49] Creep speed".

8.2.3 Zero point return method (1): Near-point dog method

The following shows an operation outline of the "near-point dog method" zero point return method.

■ Operation chart

1)	The machine zero point return is started. (The machine begins the acceleration designated in "[Pr.53] Zero point return acceleration time selection", in the direction designated in "[Pr.46] Zero point return direction". It then moves at the "[Pr.48] Zero point return speed" when the acceleration is completed.)
2)	The machine begins decelerating when the near-point dog ON is detected.
3)	The machine decelerates to the "[Pr.49] Creep speed", and subsequently moves at that speed.
4)	After the near-point dog turns OFF, the pulse output from the AD75 will stop at the first zero point signal, outputting a "deviation counter clear signal" to the drive unit.
5)	After a "deviation counter clear signal" is output to the drive unit, the zero point return complete flag ([Md.40] Status: b4) turns from OFF to ON and the zero point return request flag ([Md.40] Status: b3) turns from ON to OFF.

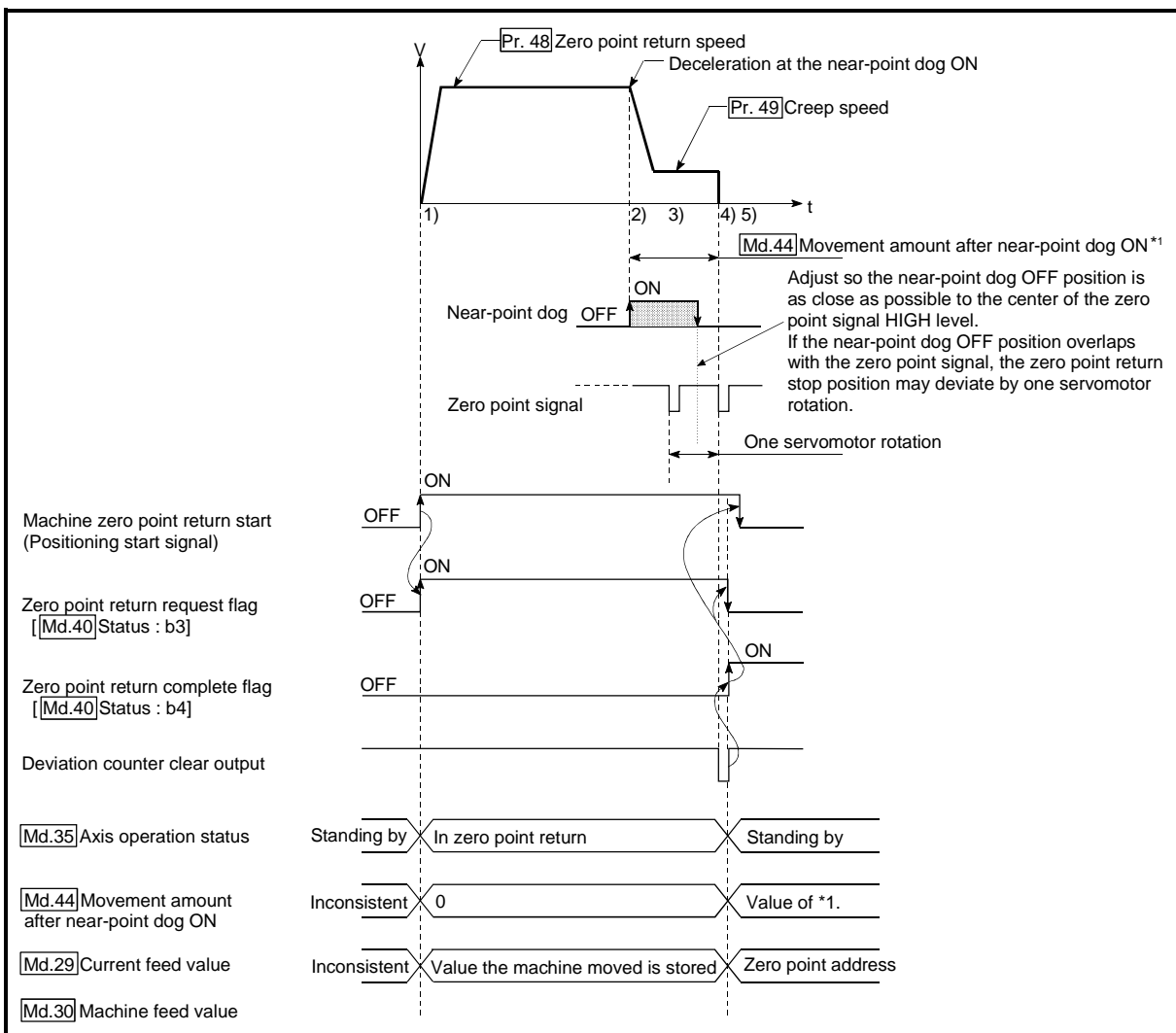

Fig. 8.2 Near-point dog method machine zero point return

■ Restrictions

A pulse generator with a zero point signal is required.

When using a pulse generator without a zero point signal, generate a zero point signal using an external signal.

■ Precautions during operation

- (1) An error "Start at zero point" (error code: 201) will occur if another machine zero point return is attempted after a machine zero point return completion when the zero point return retry function is not set ("0" is set in "[Pr.50] Zero point return retry").
- (2) Machine zero point returns carried out from the near-point dog ON position will start at the "[Pr.49] Creep speed".
- (3) The near-point dog must be ON during deceleration from the zero point return speed "[Pr.49] Creep speed".
- (4) If the restart command is turned ON after machine zero point return is stopped upon a stop signal, an error "zero point return restart not possible" (error code: 209) occurs.

8.2.4 Zero point return method (2): Stopper stop method 1)

The following shows an operation outline of the "stopper stop method 1)" zero point return method.

■ Operation chart

1)	The machine zero point return is started. (The machine begins the acceleration designated in "[Pr.53] Zero point return acceleration time selection", in the direction designated in "[Pr.46] Zero point return direction". It then moves at the "[Pr.48] Zero point return speed" when the acceleration is completed.)
2)	The machine begins decelerating when the near-point dog ON is detected. (Torque limiting is required at this time. If the torque is not limited, the servomotor may fail in step 4).)
3)	The machine decelerates to the "[Pr.49] Creep speed", and subsequently moves at that speed.
4)	The machine presses against the stopper at the creep speed and stops.
5)	The pulse output from the AD75 will stop when the "[Pr.51] Zero point return dwell time" has elapsed after the near-point dog turns ON, outputting the "deviation counter clear output" to the drive unit.
6)	After a "deviation counter clear output" is output to the drive unit, the zero point return complete flag ([Md.40] Status: b4) turns from OFF to ON, and the zero point return request flag ([Md.40] Status: b3) turns from ON to OFF.

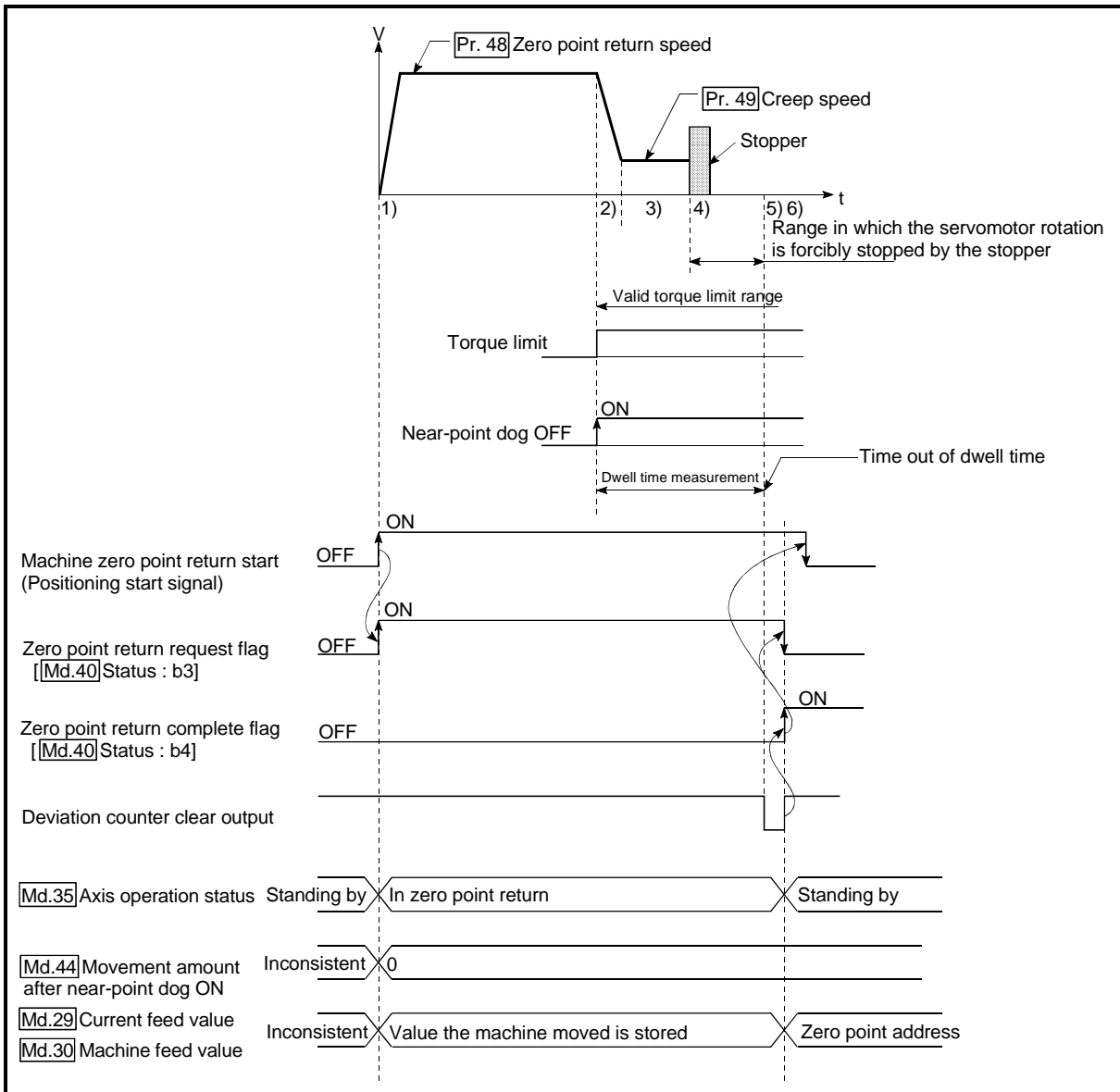

Fig. 8.3 Stopper stop method 1) machine zero point return

■ Restrictions

- (1) Always limit the servomotor torque after starting deceleration.
If the torque is not limited, the servomotor may fail when the machine presses against the stopper. (Refer to section "12.4.2 Torque limit function".)
- (2) The zero point return retry function cannot be used with the "stopper stop method 1)."

■ Precautions during operation

- (1) Set a value in the "Pr.51 Zero point return dwell time" that is equal to or higher than the movement time from the near-point dog ON to the time the machine presses against the stopper.
- (2) If the "Pr.51 Zero point return dwell time" elapses during deceleration from the "Pr.48 Zero point return speed," deceleration and stop are caused, resulting in an error "dwell time fault" (error code: 205).

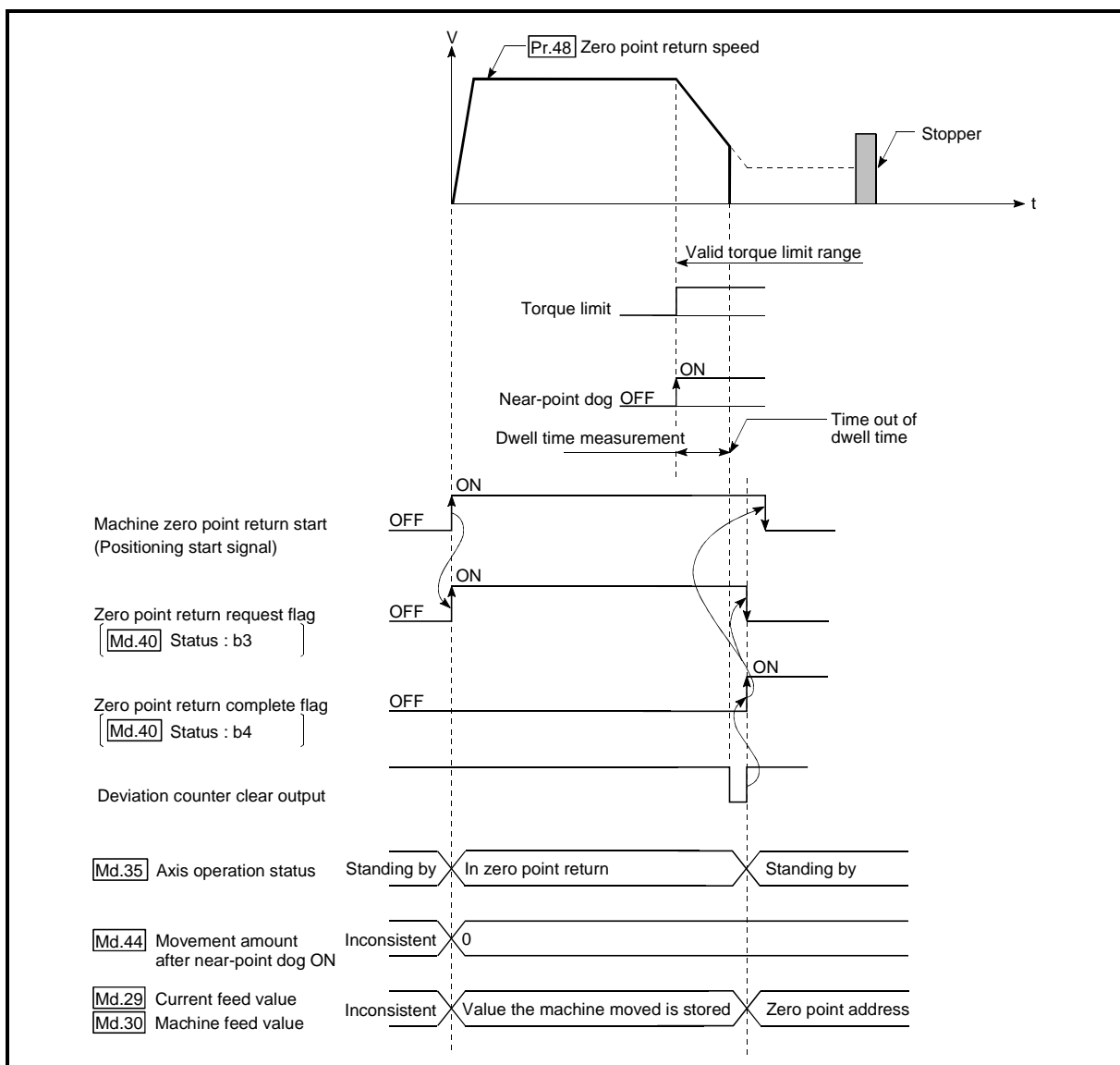

Fig. 8.4 Operation when the dwell time elapses during deceleration from the zero point return speed

- (3) If the "[Pr.51] Zero point return dwell time" elapses before the stop at the stopper, the workpiece will stop at that position, and that position will be regarded as the zero point.

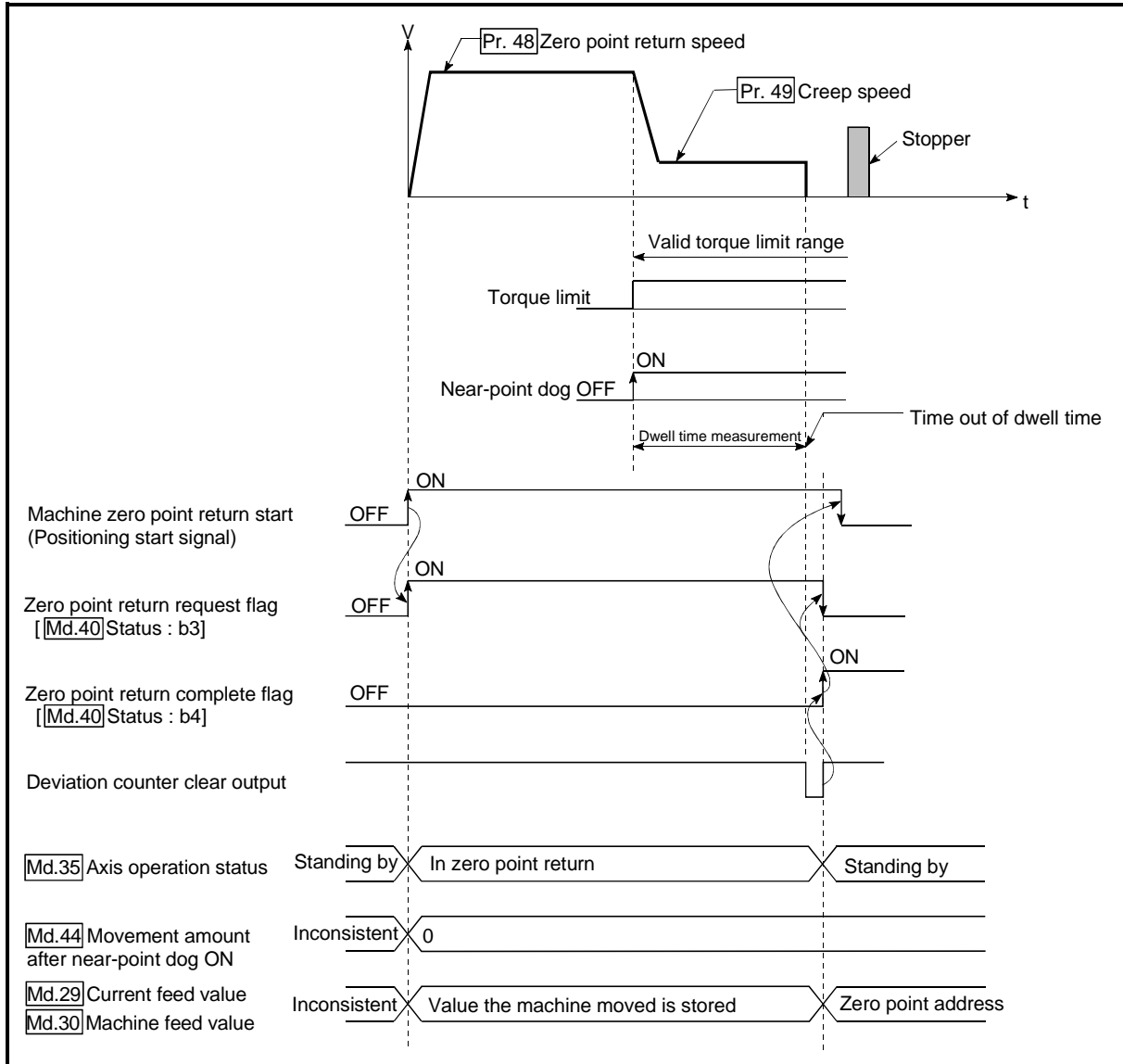

Fig. 8.5 Operation when the dwell time elapses before the stop at the stopper

- (4) Machine zero point returns started while the near-point dog is ON will start at the "[Pr.49] Creep speed".
- (5) If the restart command is turned ON after machine zero point return is stopped upon a stop signal, an error "zero point return restart not possible" (error code: 209) occurs.

8.2.5 Zero point return method (3): Stopper stop method 2)

The following shows an operation outline of the "stopper stop method 2)" zero point return method.

■ Operation chart

1)	The machine zero point return is started. (The machine begins the acceleration designated in "[Pr.53] Zero point return acceleration time selection", in the direction designated in "[Pr.46] Zero point return direction". It then moves at the "[Pr.48] Zero point return speed" when the acceleration is completed.)
2)	The machine begins decelerating when the near-point dog ON is detected. (Torque limiting is required at this time. If the torque is not limited, the servomotor may fail in step 4.)
3)	The machine decelerates to the "[Pr.49] Creep speed", and subsequently moves at that speed. (Torque limiting is required at this time. If the torque is not limited, the servomotor may fail in step 4.)
4)	The machine presses against the stopper at the creep speed and stops.
5)	The pulse output from the AD75 will stop at the zero point signal after the machine stops, outputting the "deviation counter clear output" to the drive unit.
6)	After a "deviation counter clear output" is output to the drive unit, the zero point return complete flag ([Md.40] Status: b4) turns from OFF to ON, and the zero point return request flag ([Md.40] Status: b3) turns from ON to OFF.

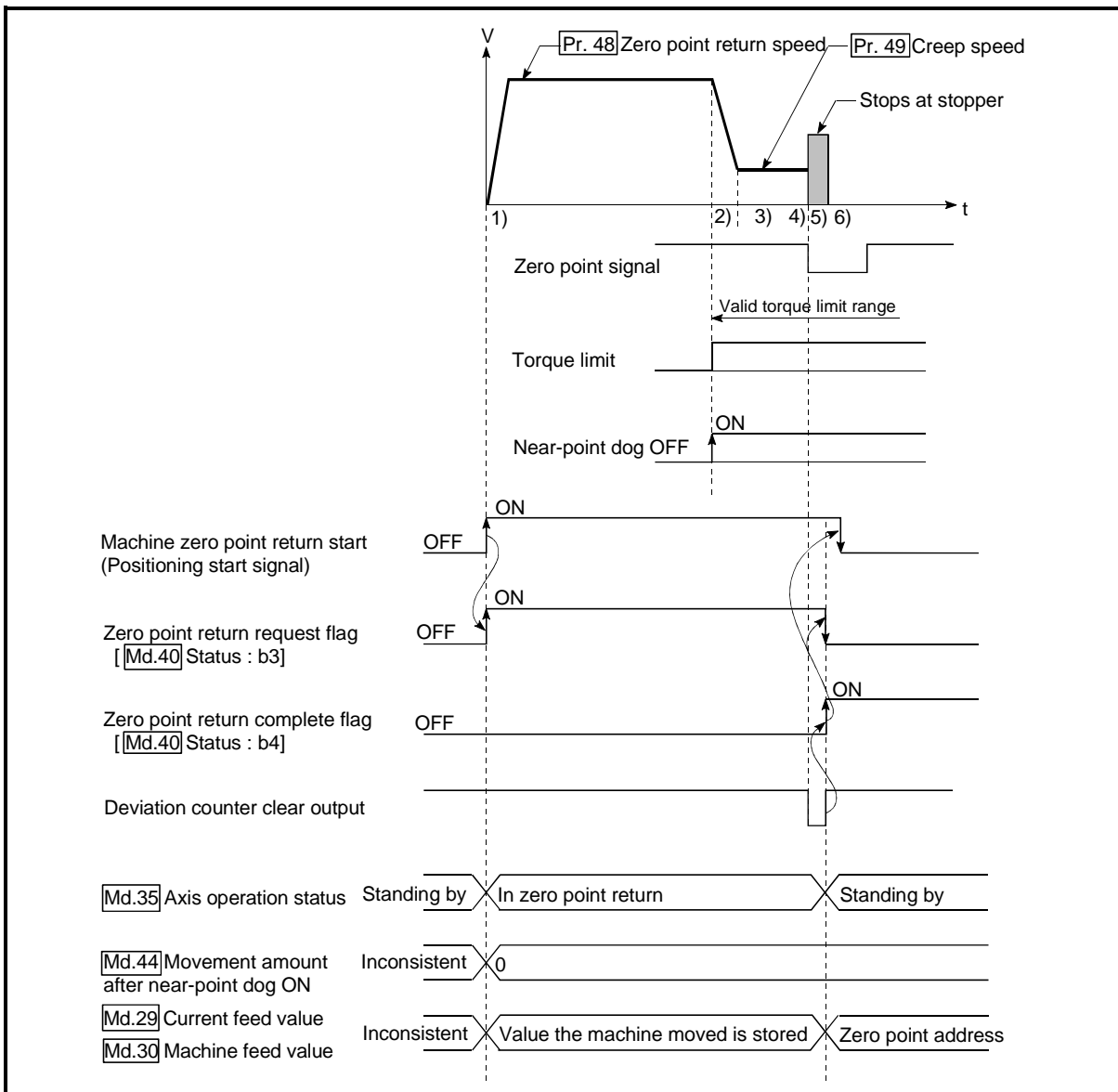

Fig. 8.6 Stopper stop method 2) machine zero point return

■ Restrictions

- (1) Always limit the servomotor torque after the "Pr.49 Creep speed" is reached. If the torque is not limited, the servomotor may fail when the machine presses against the stopper. (Refer to section "12.4.2 Torque limit function".)
- (2) Use an external input signal as the zero point signal.
- (3) In the "stopper method 2)", the zero point return retry function is unusable.

■ Precautions during operation

- (1) Input a zero point signal from an external source after the machine presses against the stopper.
The workpiece will continue decelerating and stop if a zero point signal is input before deceleration to the "Pr.49 Creep speed". An error "zero point detection timing fault (error code: 204)" will occur after the machine stops.
- (2) The near-point dog must be kept turned ON until contact with the stopper.

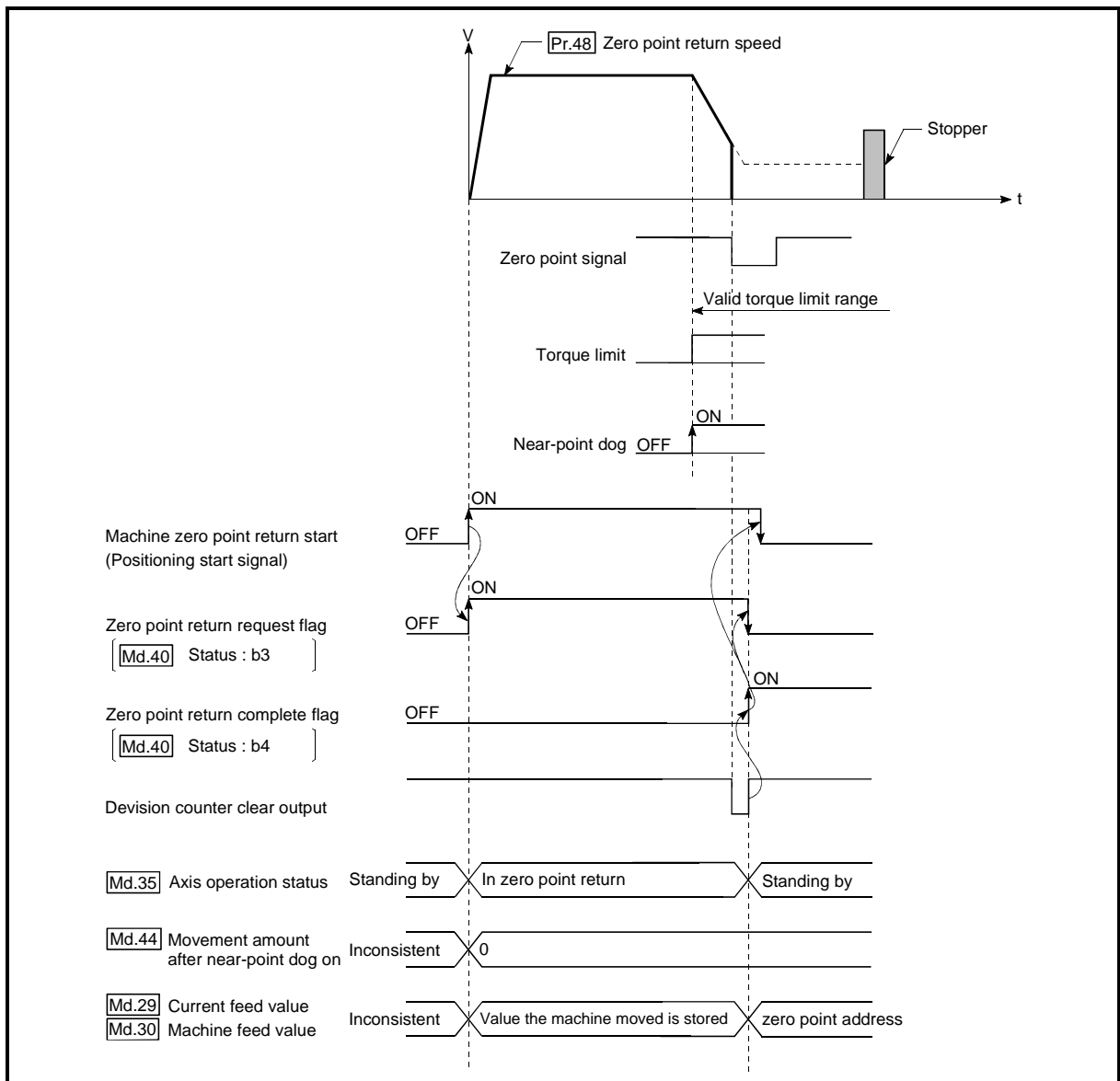

Fig. 8.7 Operation when a zero point signal is input before the creep speed is reached

- (3) If the zero point signal is input before the workpiece stops at the stopper, the workpiece will stop at that position, and that position will be regarded as the zero point.
At this time, an error will not occur.

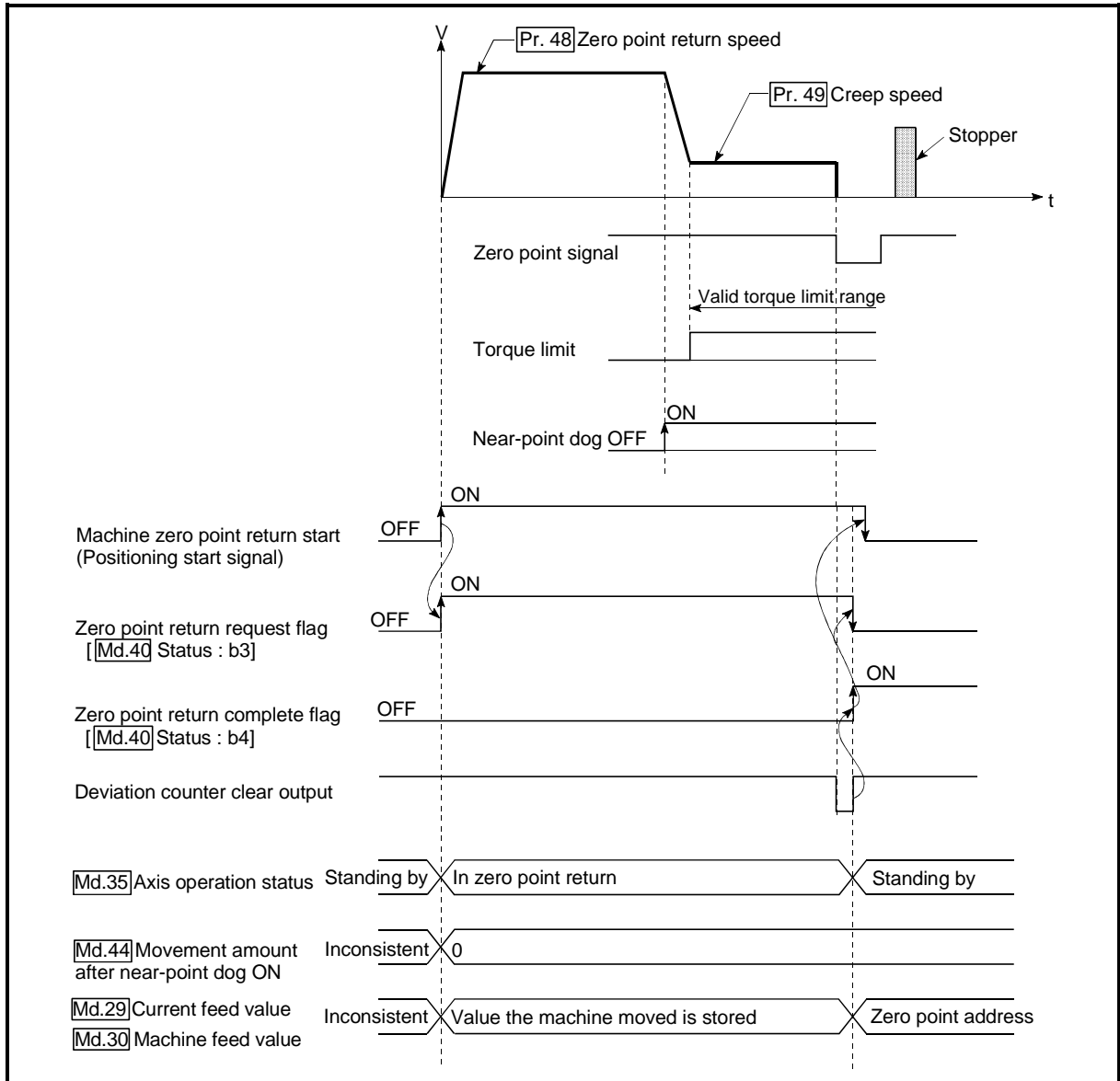

Fig. 8.8 Operation when the zero point signal is input before the stop at the stopper

- (4) Machine zero point returns started while the near-point dog is ON will start at the "Pr.49 Creep speed".
- (5) If the restart command is turned ON after machine zero point return is stopped upon a stop signal, an error "zero point return restart not possible" (error code: 209) occurs.

8.2.6 Zero point return method (4): Stopper stop method 3)

The following shows an operation outline of the "stopper stop method 3)" zero point return method.

The "stopper stop method 3)" method is effective when a near-point dog has not been installed. (Note that the operation is carried out from the start at the "[Pr.49] Creep speed", so it will take some time until the machine zero point return completion.)

■ Operation chart

1)	The machine zero point return is started. (The machine moves at the "[Pr.49] Creep speed", in the direction designated in "[Pr.46] Zero point return direction". Torque limiting is required at this time. If the torque is not limited, the servomotor may fail when the machine presses against the stopper in step 2.)
2)	The machine presses against the stopper at the "[Pr.49] Creep speed" and stops.
3)	The pulse output from the AD75 will stop at the zero point signal after the machine stops, outputting the "deviation counter clear output" to the drive unit.
4)	After a "deviation counter clear output" is output to the drive unit, the zero point return complete flag ([Md.40] Status: b4) turns from OFF to ON, and the zero point return request flag ([Md.40] Status: b3) turns from ON to OFF.

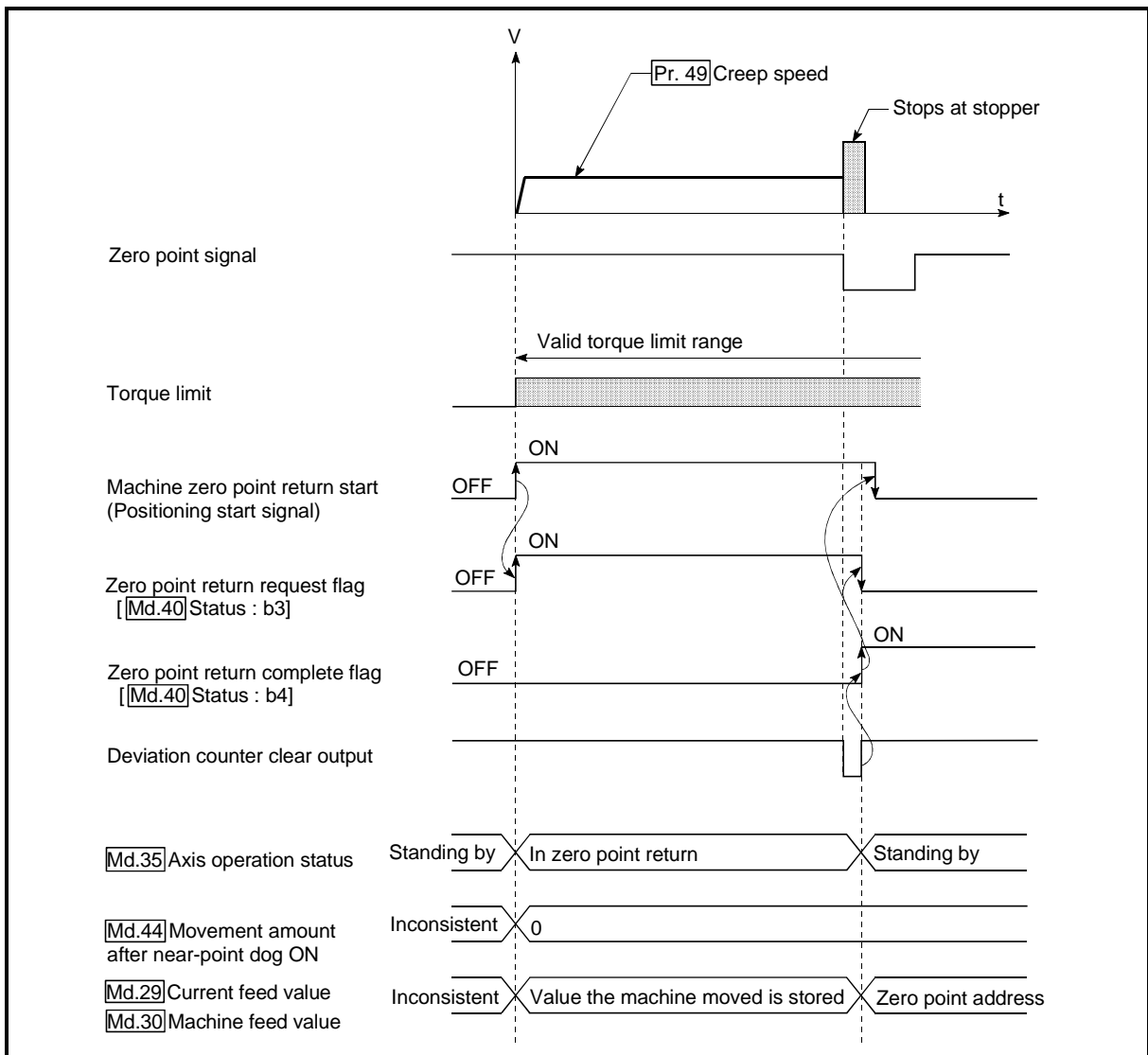

Fig. 8.9 Stopper stop method 3) machine zero point return

■ Restrictions

- (1) Always limit the servomotor torque after the "[Pr.49] Creep speed" is reached. If the torque is not limited, the servomotor may fail when the machine presses against the stopper. (Refer to section "12.4.2 Torque limit function".)
- (2) Use an external input signal as the zero point signal.
- (3) The zero point retry function cannot be used in "stopper stop method 3)".

■ Precautions during operation

- (1) If the zero point signal is input before the workpiece stops at the stopper, the workpiece will stop at that position, and that position will become the zero point. At this time, an error will not occur.

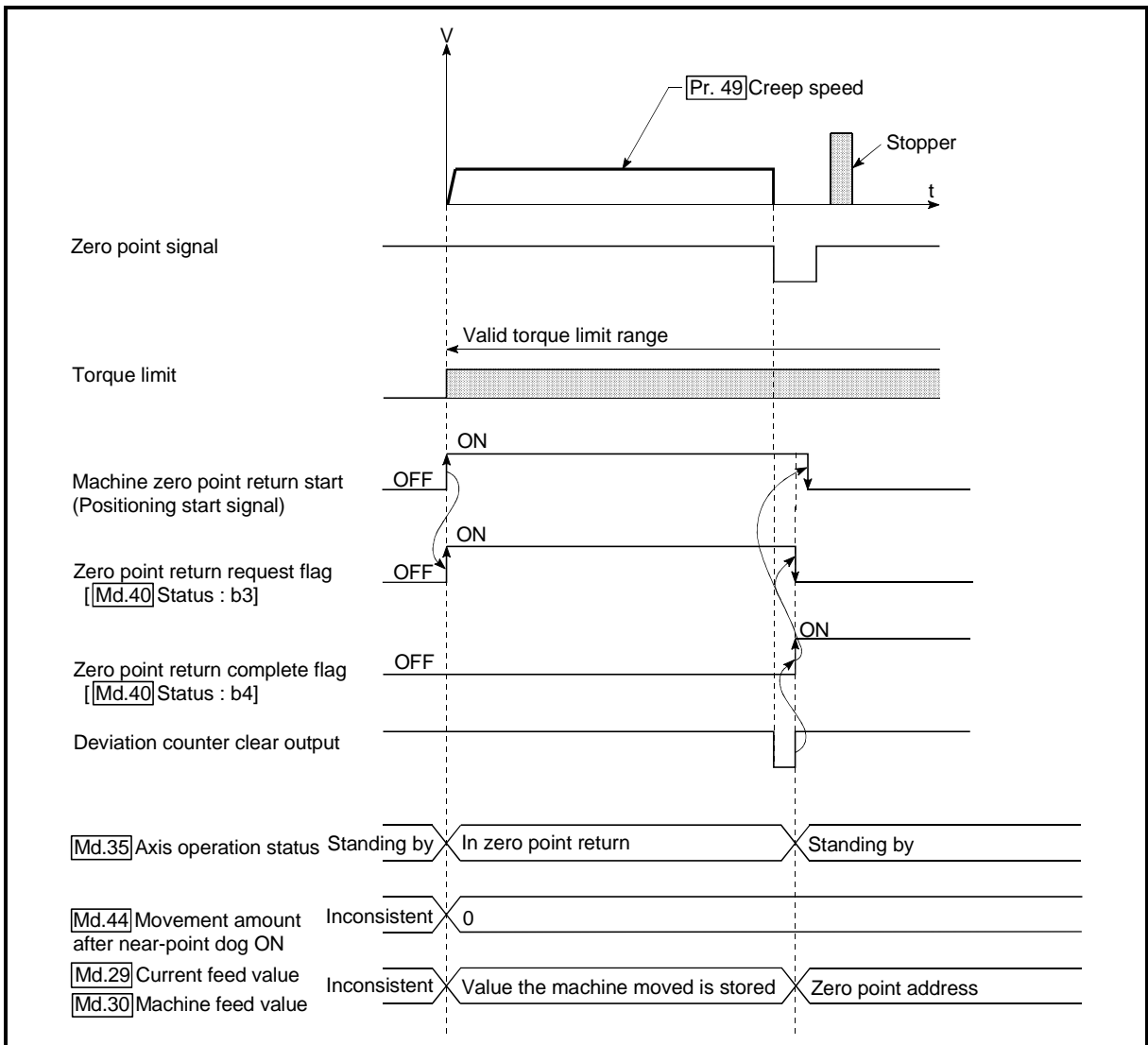

Fig. 8.10 When the zero point signal is input before the stop at the stopper

- (2) If the restart command is turned ON after machine zero point return is stopped upon a stop signal, an error "zero point return restart not possible" (error code: 209) occurs.

8.2.7 Zero point return method (5): Count method 1)

The following shows an operation outline of the "count method 1)" zero point return method.

■ Operation chart

1)	The machine zero point return is started. (The machine begins the acceleration designated in "[Pr.53] Zero point return acceleration time selection", in the direction designated in "[Pr.46] Zero point return direction". It then moves at the "[Pr.48] Zero point return speed" when the acceleration is completed.)
2)	The machine begins decelerating when the near-point dog ON is detected.
3)	The machine decelerates to the "[Pr.49] Creep speed", and subsequently moves at that speed.
4)	On detection of the first zero point signal after the axis has traveled the movement amount set in the "[Pr.52] Setting for the movement amount after near-point dog ON" after the near-point dog ON, the pulse output from the AD75 stops and the "deviation counter clear output" is output to the drive unit.
5)	After a "deviation counter clear output" is output to the drive unit, the zero point return complete flag ([Md.40] Status: b4) turns from OFF to ON, and the zero point return request flag ([Md.40] Status: b3) turns from ON to OFF.

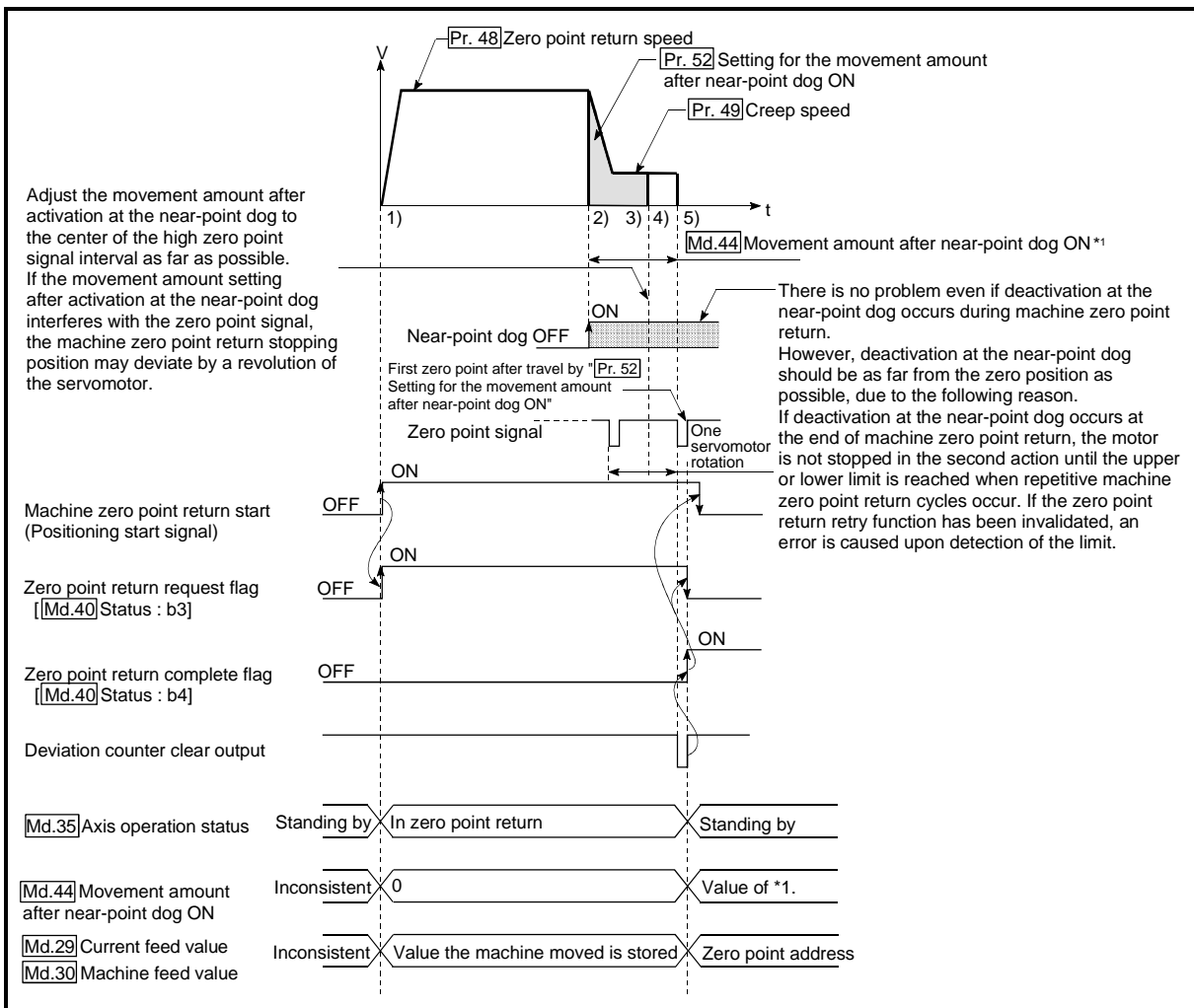

Fig. 8.11 Count method1) machine zero point return

■ Restrictions

A pulse generator with a zero point signal is required.

When using a pulse generator without a zero point signal, generate a zero point signal using an external signal.

■ Precautions during operation

- (1) If "Pr.52 Setting for the movement amount after near-point dog ON" is smaller than the deceleration distance traveled from "Pr.48 Zero point return speed" to "Pr.49 Creep speed," an error "count method movement amount fault" (error code: 206) occurs to cause a failure to start.
- (2) The following shows the operation when a machine zero point return is started while the near-point dog is ON.

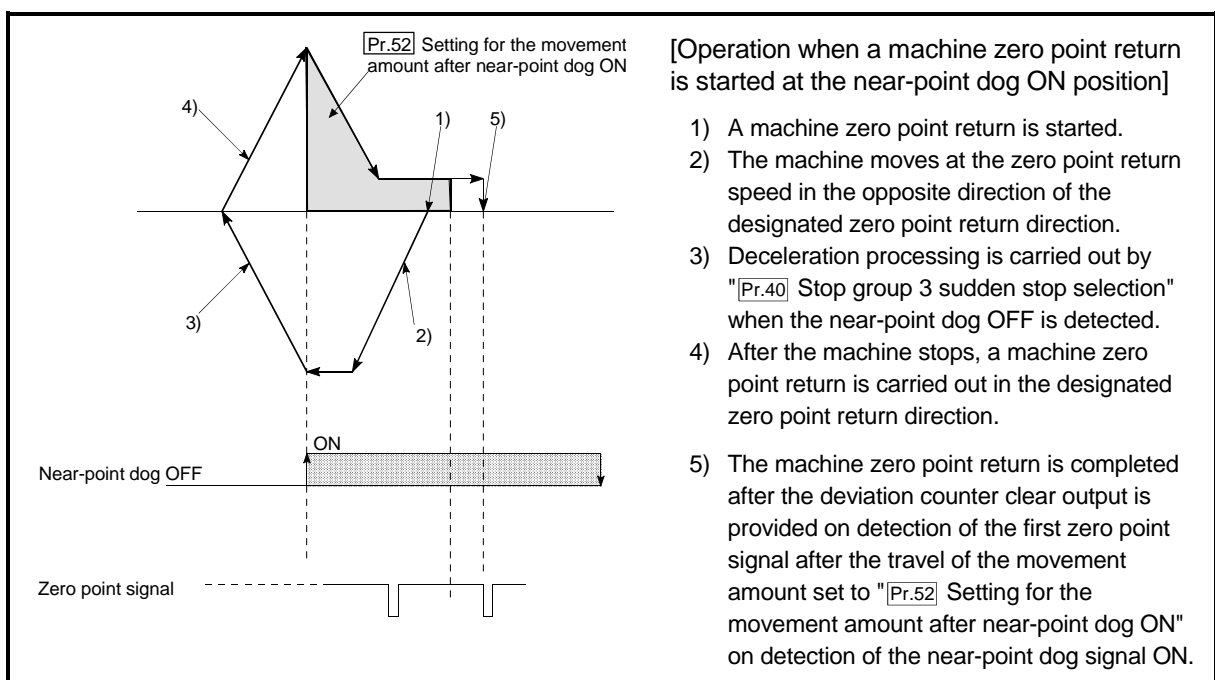

Fig. 8.12 Count method 1) machine zero point return on the near-point dog ON position

- (3) If the restart request is turned ON after zero point return is stopped upon a stop signal, an error "zero point return restart not possible" (error code: 209) occurs.

REMARK

- With the "count method 1)" machine zero point return, return to the machine zero point can be made at the near-point dog ON.
- With the "count method 1)" machine zero point return, continuous start can be made after return to the machine zero point is completed.

8.2.8 Zero point return method (6): Count method 2)

The following shows an operation outline of the "count method 2)" zero point return method.

The "count method 2)" method is effective when a "zero point signal" cannot be received. (Note that compared to the "count method 1)" method, using this method will result in more deviation in the stop position during machine zero point returns.)

■ Operation chart

1)	The machine zero point return is started. (The machine begins the acceleration designated in "[Pr.53] Zero point return acceleration time selection", in the direction designated in "[Pr.46] Zero point return direction". It then moves at the "[Pr.48] Zero point return speed" when the acceleration is completed.)
2)	The machine begins decelerating when the near-point dog ON is detected.
3)	The machine decelerates to the "[Pr.49] Creep speed", and subsequently moves at that speed.
4)	The pulse output from the AD75 will stop and the machine zero point return will be completed when the machine moves the movement amount set in "[Pr.52] Setting for the movement amount after near-point dog ON" from the near-point dog ON position.

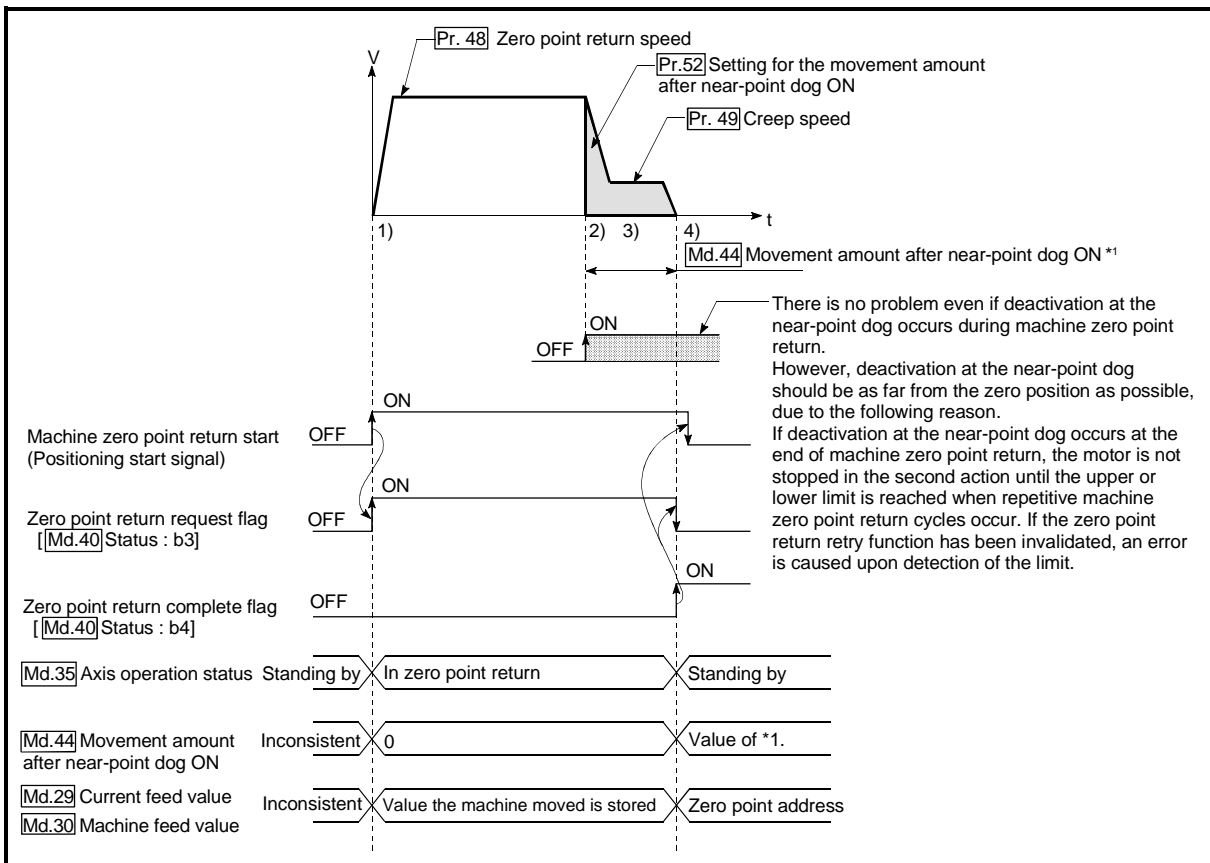

Fig. 8.13 Count method 2) machine zero point return

■ Restrictions

When this method is used, a deviation will occur in the stop position (zero point) compared to other zero point return methods because an error of about 1 ms occurs in taking in the near-point dog ON.

■ Precautions during operation

- (1) If "Pr.52 Setting for the movement amount after near-point dog ON" is smaller than the deceleration distance traveled from "Pr.48 Zero point return speed" to "Pr.49 Creep speed," an error "count method movement amount fault" (error code: 206) occurs to cause a failure to start.
- (2) The following shows the operation when a machine zero point return is started while the near-point dog is ON.

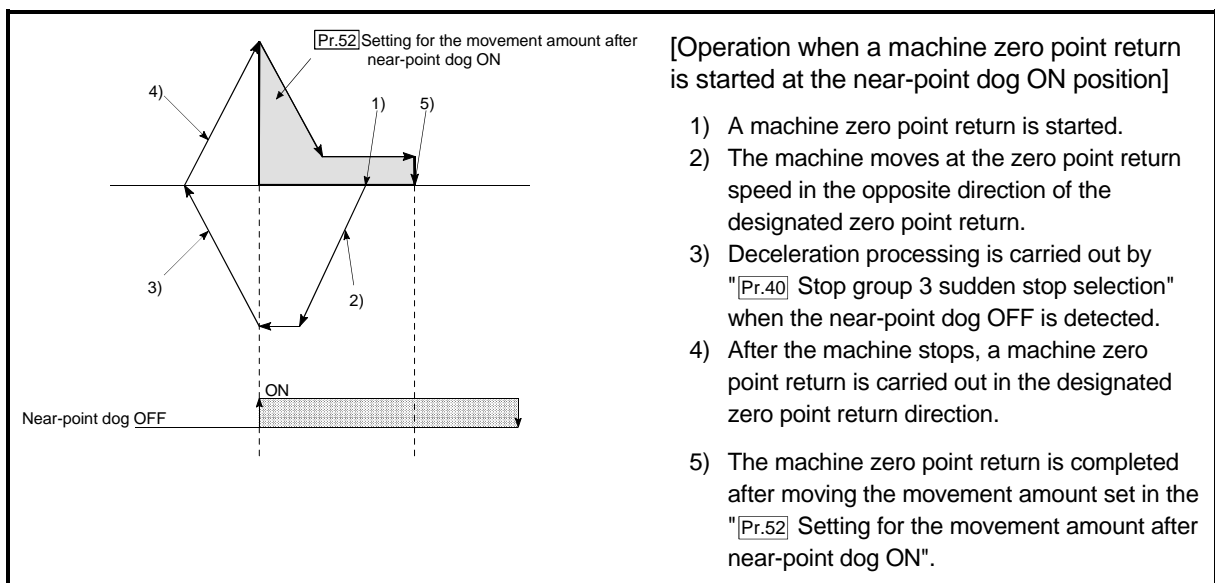

Fig. 8.14 Count method 2) machine zero point return on the near-point dog ON position

- (3) If the restart command is turned ON after machine zero point return is stopped upon a stop signal, an error "zero point return restart not possible" (error code: 209) occurs.

8.3 High-speed zero point return

8.3.1 Outline of the high-speed zero point return operation

■ High-speed zero point return operation

In a high-speed zero point return, positioning is carried out by a machine zero point return to the "[Md.43] Zero point absolute position" stored in the AD75. The following shows the operation during a high-speed zero point return start.

- 1) The high-speed zero point return is started.
- 2) Positioning control begins to the "[Md.43] Zero point absolute position", following the speed set in the zero point return parameters ([Pr.45] to [Pr.58]).
- 3) The high-speed zero point return is completed.

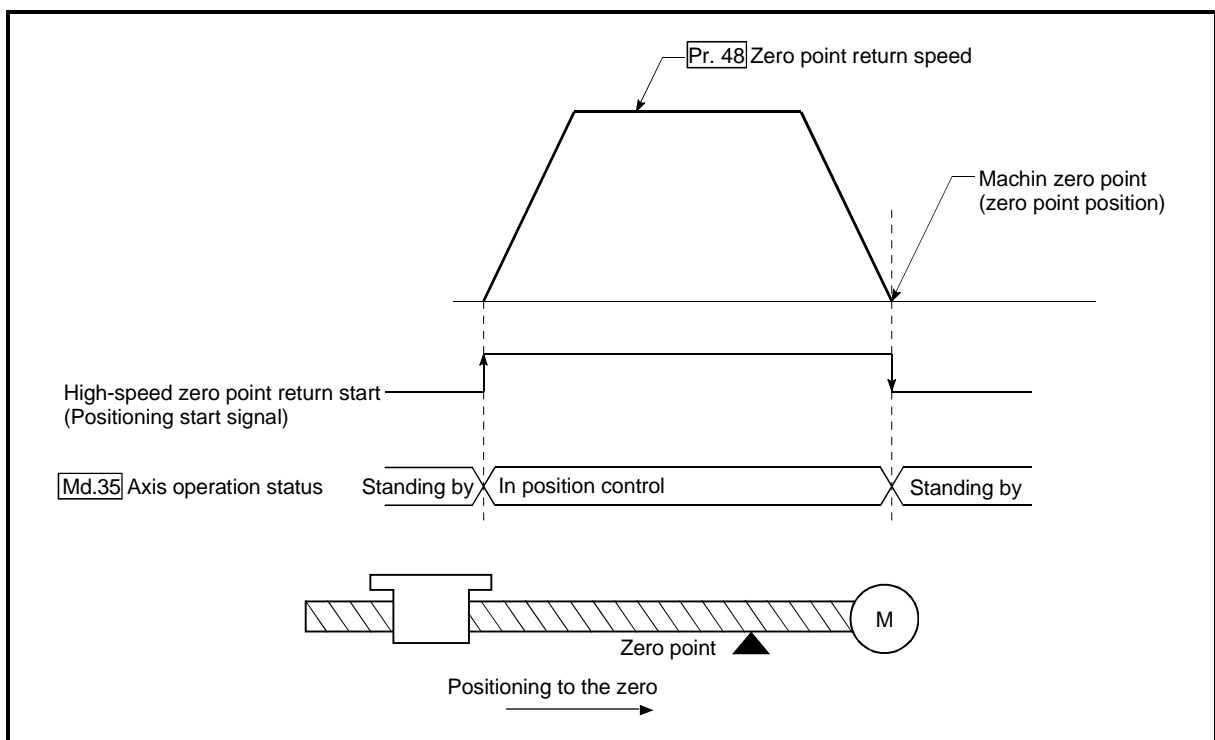

Fig. 8.15 High-speed zero point return

■ Operation timing and processing time of high-speed zero point returns

The following shows details about the operation timing and time during high-speed zero point returns

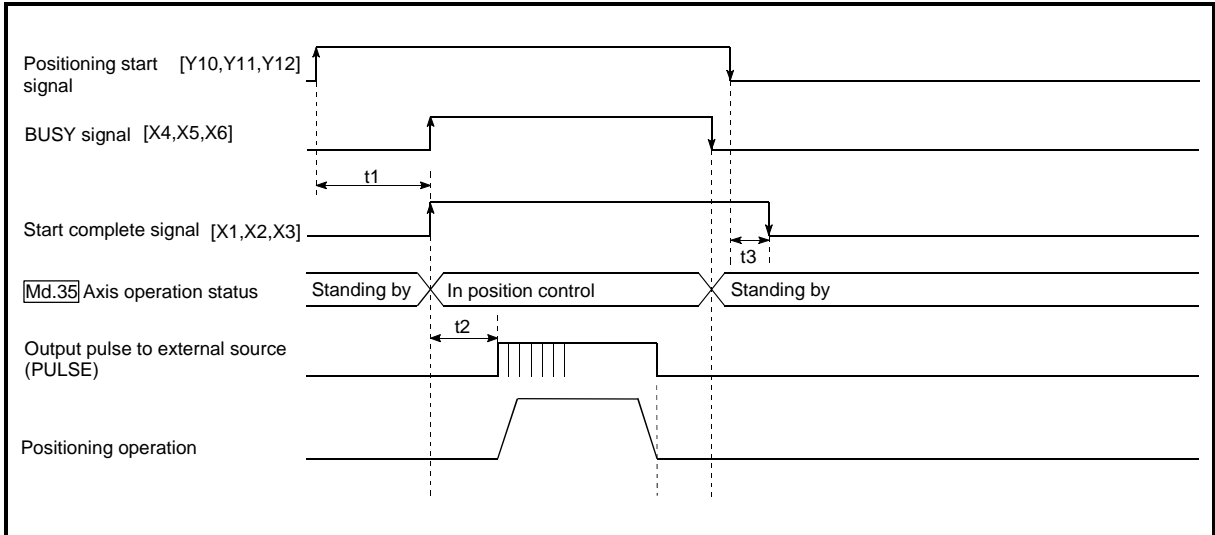

Fig. 8.16 Operation timing and processing time of high-speed zero point returns

Normal timing time		Unit: ms
t1	t2	t3
5 to 15	0 to 3.5	

- The t1 timing time could be delayed by the following factors.
 - 1) Presence of FROM/TO command execution during start process
 - 2) Operation state of other axes
 - 3) Presence of intervention from peripheral device during start process
 - 4) Details of positioning data to be started

■ Operating restrictions

When the zero point return complete flag ([Md.40] Status: b3) is ON, executing a high-speed zero point return start will result in an error "zero point return request ON" (error code: 207)".

8.4 Positioning to the zero point

Positioning to the zero point is explained in this section.

To carry out positioning to the zero point, "1-axis linear control (ABS) positioning data" is created in which the "[Md.43] Zero point absolute position" is set in the positioning address ([Da.5]). In this case, the other positioning data items are set beforehand in the flash ROM. (This control is called a "high-speed machine zero point return".)

- * The "[Pr.47] Zero point address" is a fixed value set by the user, but the "[Md.43] Zero point absolute position" is constantly changed by the AD75 to indicate the "zero point", even if there is a change in the address information.

■ Restrictions

[Md.43] Zero point absolute position is not modified in following cases.

- Feeding actual value 0 clear when starting fixed dimensions feeding. (Refer to section 9.2.4 and 9.2.5)
 - Feeding actual value 0 clear when controlling speed. (Refer to section 9.2.8)
 - Updating feeding actual value when controlling speed. (Refer to section 9.2.8)
- The "zero point absolute position overflow/underflow flags" ([Md.40] Status: b11/b12) must be turned OFF.

■ Positioning data setting example

The following table shows setting examples in which "zero point positioning" is set in the positioning data No. 100 of axis 1.

Setting item		Setting example	Setting details
Axis 1 Positioning data No. 1	[Da.1] Operation pattern	Positioning complete	Set "Positioning complete" so the next positioning data is not executed.
	[Da.2] Control method	ABS linear 1	Set the absolute system 1-axis linear control.
	[Da.3] Acceleration time No.	0	Designate the value set in "[Pr.8] Acceleration time 0" as the acceleration time at start.
	[Da.4] Deceleration time No.	0	Designate the value set in "[Pr.9] Deceleration time 0" as the deceleration time at deceleration.
	[Da.5] Positioning address/movement amount	→	Set "[Md.43] Zero point absolute position" in the positioning address. (Assuming that the "[Pr.1] Unit setting" is set to "mm".)
	[Da.6] Arc address	-	Setting not required. (Setting value will be ignored.)
	[Da.7] Command speed	20.00mm/min	Set the speed when moving to the positioning address.
	[Da.8] Dwell time	500ms	Set the time from the positioning stop (pulse output stop) to the output of the positioning complete signal.
	[Da.9] M code	0	Set when carrying out other auxiliary operation commands in combination with the No. 1 positioning data

* Refer to section "5.3 List of positioning data" for information on the setting details.

■ Start time chart

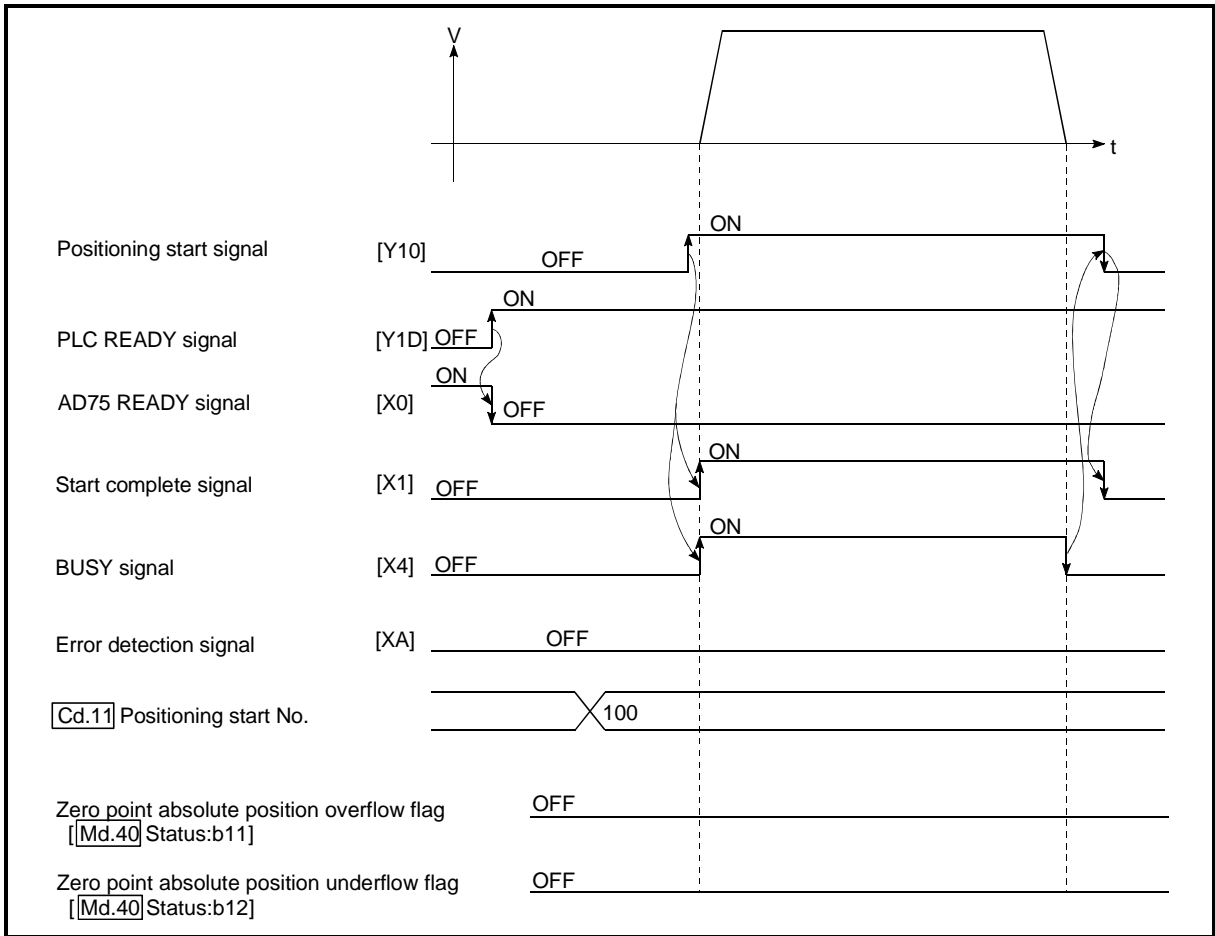
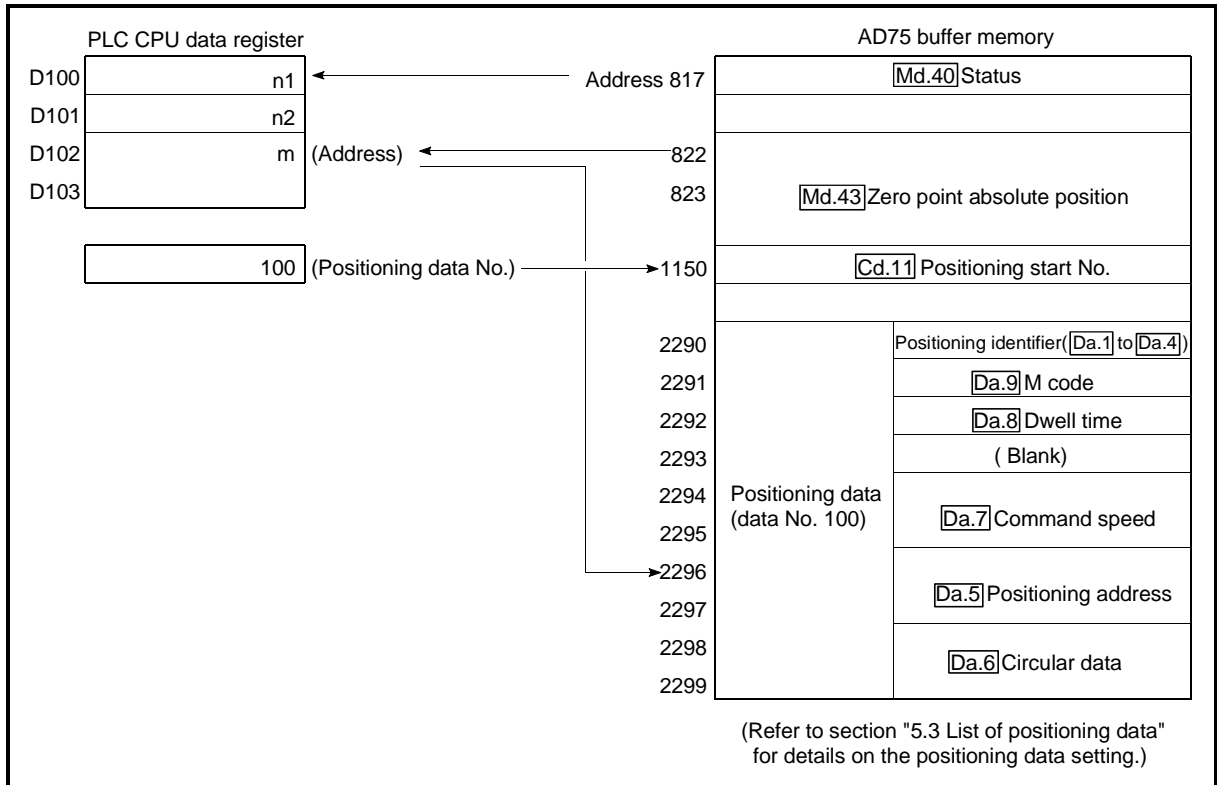
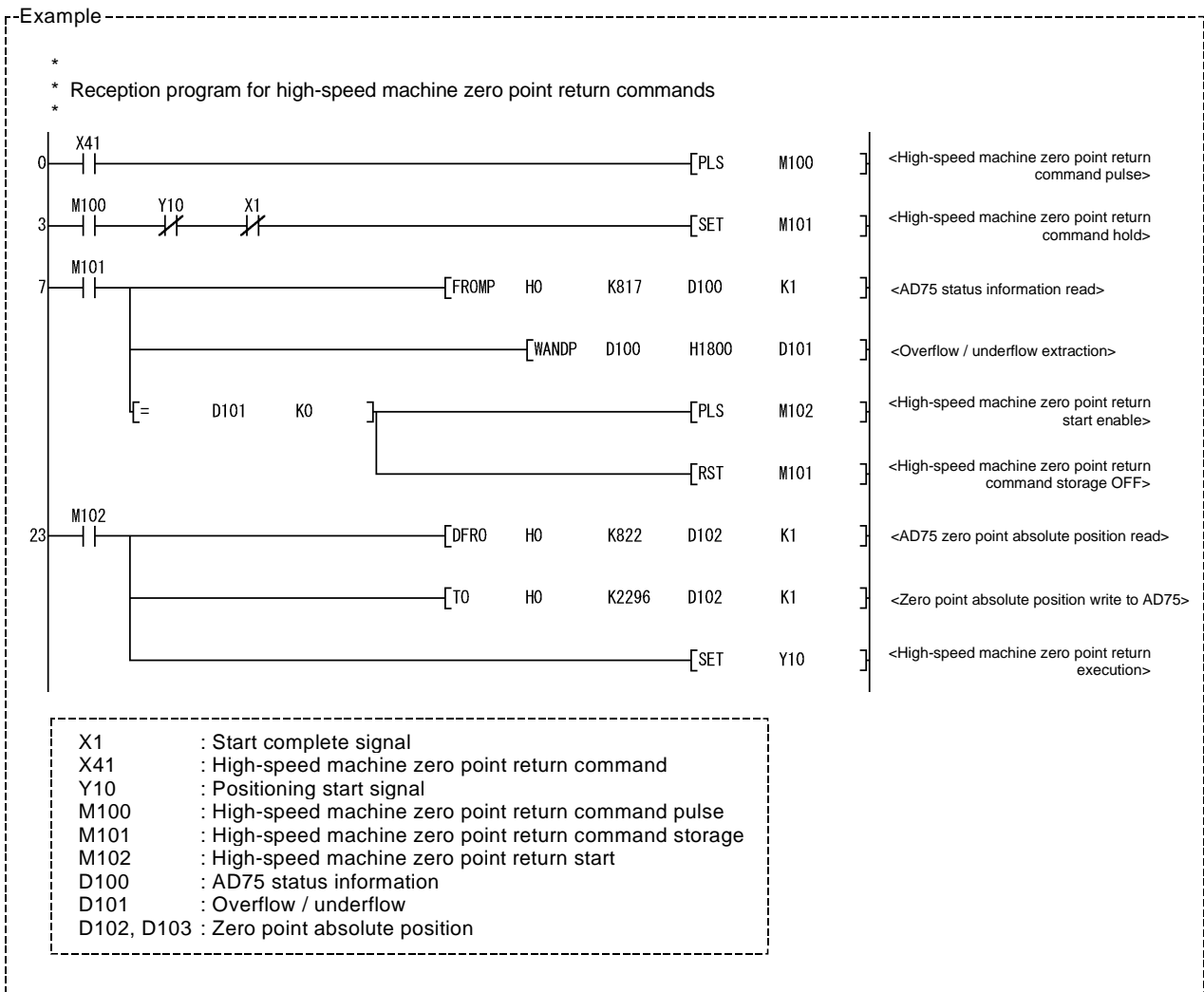

Fig. 8.17 Start time chart for positioning to the zero point

■ Creating the program





MEMO

Chapter 9

MAIN POSITIONING CONTROL

The details and usage of the main positioning controls (control functions using the "positioning data") are explained in this chapter.

The main positioning controls include such controls as "positioning control" in which positioning is carried out to a designated position using the address information, "speed control" in which a rotating object is controlled at a constant speed, and "speed/position changeover control" in which the operation is shifted from "speed control" to "position control".

Carry out the required settings to match each control.

9.1	Outline of main positioning controls.....	9- 2
9.1.1	Data required for main positioning control	9- 3
9.1.2	Operation patterns of main positioning controls	9- 4
9.1.3	Designating the positioning address	9- 14
9.1.4	Confirming the current value	9- 15
9.1.5	Control unit "degree" handling.....	9- 17
9.1.6	Interpolation control	9- 19
9.2	Setting the positioning data	9- 22
9.2.1	Relation between each control and positioning data.....	9- 22
9.2.2	1-axis linear control.....	9- 23
9.2.3	2-axis linear interpolation control.....	9- 25
9.2.4	1-axis fixed-dimension feed control.....	9- 29
9.2.5	2-axis fixed-dimension feed control (interpolation)	9- 31
9.2.6	2-axis circular interpolation control with auxiliary point designation.....	9- 33
9.2.7	2-axis circular interpolation control with center point designation.....	9- 39
9.2.8	Speed control.....	9- 46
9.2.9	Speed/position changeover control.....	9- 48
9.2.10	Current value change	9- 55
9.2.11	JUMP command	9- 60

9.1 Outline of main positioning controls

"Main positioning controls" are carried out using the "positioning data" stored in the AD75.

The basic controls such as position control and speed control are executed by setting the required items in this "positioning data", and then starting that positioning data.

The control method for the "main positioning controls" is set in setting item "Da.2 Control method" of the positioning data.

Control defined as a "main positioning control" carries out the following types of control according to the "Da.2 Control method" setting.

Main positioning control		Da.2 Control method	Details	
Position control *	Linear control	1-axis linear control	ABS Linear 1 INC Linear 1	Positioning is carried out in a linear path to a position designated by the address and movement amount set in the positioning data.
		2-axis linear interpolation control *	ABS Linear 2 INC Linear 2	The axis in which the interpolation control method is set is regarded as the reference axis. Positioning is carried out in a linear path to a designated position, while controlling the other axis (interpolation axis) to match the positioning data set in the reference axis.
	Fixed-dimension feed control	1-axis fixed-dimension feed control	Fixed-dimension feed 1	The workpiece is positioned the movement amount designated by the movement amount set in the positioning data. (The "Md.29 Current feed value" is set to "0" at the start.)
		2-axis fixed-dimension feed control *	Fixed-dimension feed 2	The axis in which the interpolation control method is set is regarded as the reference axis. Positioning is carried out in a linear path for the designated movement amount, while controlling the other axis (interpolation axis) to match the positioning data set in the reference axis. (The "Md.29 Current feed value" is set to "0" at the start.)
	2-axis circular interpolation control *	Auxiliary point designation	ABS Circular interpolation INC Circular interpolation	The axis in which the interpolation control method is set is regarded as the reference axis. Positioning is carried out in an arc path to a designated position, while controlling the other axis (interpolation axis) to match the positioning data set in the reference axis.
Center point designation		ABS Circular right ABS Circular left INC Circular right INC Circular left		
Speed control		Forward run Speed control Reverse run Speed control	Pulses are continuously output corresponding to the command speed set in the positioning data.	
Speed/position changeover control		Forward run speed/position Reverse run speed/position	The control is continued as position control (positioning for the designated movement amount) by turning ON the "speed/position changeover signal" after first carrying out speed control.	
Other control	Current value change	Current value change	The "Md.29 Current feed value" is changed to an address set in the positioning data. This can be carried out by either of the following 2 methods. (The machine feed value cannot be changed.) <ul style="list-style-type: none"> • Current value change using the positioning data • Current value change using the current value change start No. (No. 9003). 	
	JUMP command	JUMP command	An unconditional or conditional JUMP is carried out to a designated positioning data No.	

* In "2-axis linear interpolation control", "2-axis fixed-dimension feed control", and "2-axis circular interpolation control", control is carried out so that linear and arc paths are drawn using a motor set in two axis directions. This kind of control is called "interpolation control". (Refer to section "9.1.6 Interpolation control" for details.)

9.1.1 Data required for main positioning control

The following table shows an outline of the "positioning data" configuration and setting details required to carry out the "main positioning controls".

Setting item		Setting details	
Positioning data No. 1	Da.1	Operation pattern	Set the method by which the continuous positioning data (Ex: positioning data No. 1, No. 2, No. 3) will be controlled. (Refer to section 9.1.2.)
	Da.2	Control method	Set the control method defined as a "main positioning control". (Refer to section 9.1.)
	Da.3	Acceleration time No.	Select and set the acceleration time at control start. (Select one of the four values set in Pr.8, Pr.26, Pr.27, and Pr.28 for the acceleration time.)
	Da.4	Deceleration time No.	Select and set the deceleration time at control stop. (Select one of the four values set in Pr.9, Pr.29, Pr.30, and Pr.31 for the deceleration time.)
	Da.5	Positioning address/movement amount	Set the target value during position control. (Refer to section 9.1.3.)
	Da.6	Arc address	Set the auxiliary point or center point address during circular interpolation control.
	Da.7	Command speed	Set the speed during the control execution.
	Da.8	Dwell time	Set the time the machine waits from the completion of the executed positioning control and the stopping of the workpiece until the judgment of the AD75 positioning completion.
	Da.9	M code	Set this item when carrying out auxiliary work (clamp and drill stops, tool replacement, etc.) corresponding to the code No. related to the positioning data execution.

* The settings and setting requirement for the setting details of Da.1 to Da.9 differ according to the Da.2 Control method". (Refer to section "9.2 Setting the positioning data".)

■ Main positioning control auxiliary functions

Refer to section "3.3.4 Combination of AD75 main functions and auxiliary functions" for details on "auxiliary functions" that can be combined with the main positioning control.

Also refer to "Chapter 12 CONTROL AUXILIARY FUNCTIONS" for details on each auxiliary function.

■ Main positioning control from peripheral devices

"Main positioning control" can be executed from the AD75 software package test mode.

Refer to the AD75 Software Package Operating Manual for details on carrying out main positioning control from the AD75 software package.

REMARK

- Up to 600 positioning data items (positioning data No.1 to 600) can be set per axis.

9.1.2 Operation patterns of main positioning controls

In "main positioning control" (advanced positioning control), "Da.1" Operation pattern" can be set to designate whether to continue executing positioning data after the started positioning data. The "operation pattern" includes the following 3 types.

- Positioning complete — (1) Independent positioning control (operation pattern: 00)
- Positioning continue — (2) Continuous positioning control (operation pattern: 01)
- (3) Continuous path control (operation pattern: 11)

The following shows examples of operation patterns when "1-axis linear control (ABS linear 1)" is set in positioning data No. 1 to No. 6 of axis 1. Details of each operation pattern are shown on the following pages.

< Operation example when "1-axis linear positioning" is set in the positioning data of axis 1 >

(Setting details)

Positioning data No.1	Positioning to address [A] at command speed [a]	Operation pattern = 11: Continuous path control
No.2	Positioning to address [B] at command speed [b]	Operation pattern = 11: Continuous path control
No.3	Positioning to address [C] at command speed [a]	Operation pattern = 01: Continuous positioning control
No.4	Positioning to address [D] at command speed [b]	Operation pattern = 01: Continuous positioning control
No.5	Positioning to address [E] at command speed [a]	Operation pattern = 00: Independent positioning control (Positioning complete)
No.6	Positioning to address [F] at command speed [a]	Operation pattern = 11: Continuous path control

No.1 Start
Control stop

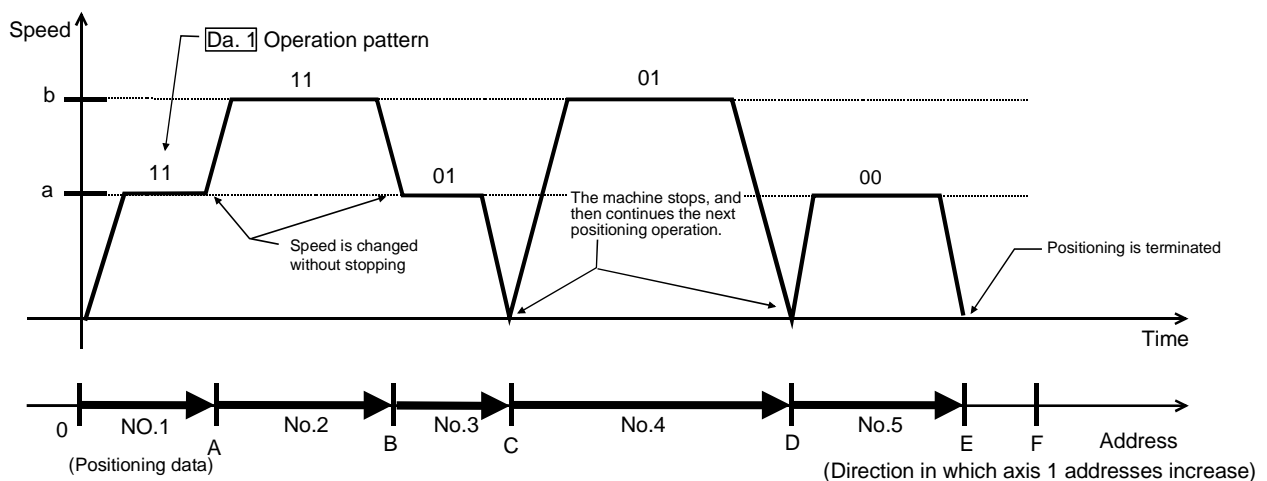

For 1-axis linear control

(One motor is driven, and positioning is carried out to an addresses designated in one direction.)

POINT

When position control of movement amount 0 is executed, the BUSY signal [X4, X5, X6] also turns ON. However, since the ON time is short, the ON status may not be detected in the sequence program.

(1) Independent positioning control (Positioning complete)

This control is set when executing only one designated data item of positioning. If a dwell time is designated, the positioning will complete after the designated time elapses.

This data (operation pattern [00] data) becomes the end of block data when carrying out block positioning. (The positioning stops after this data is executed.)

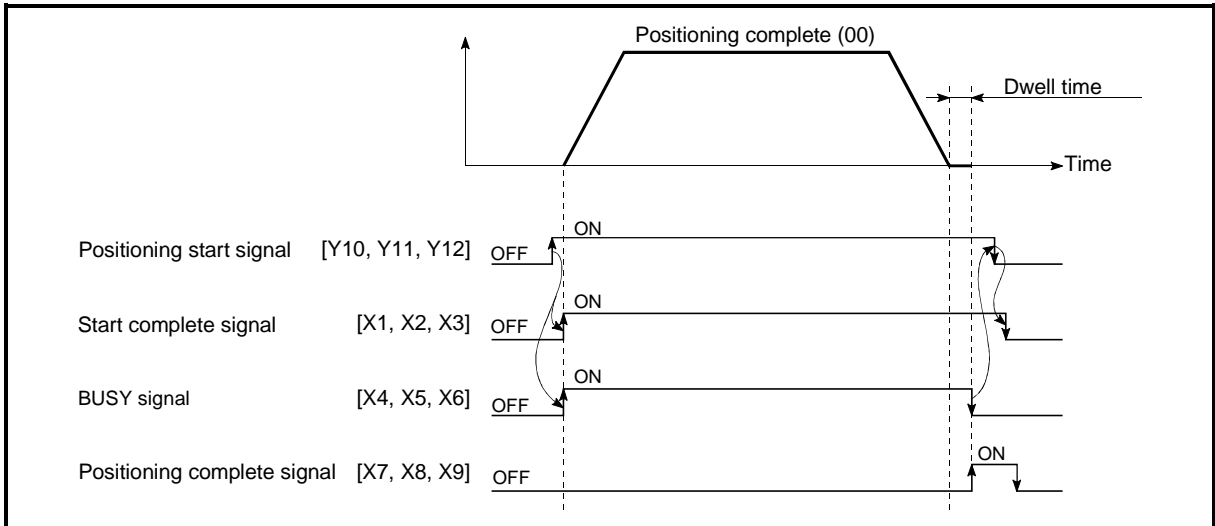

Fig. 9.1 Operation during independent positioning control

(2) Continuous positioning control

- (a) The machine always automatically decelerates each time the positioning is completed. Acceleration is then carried out after the AD75 command speed reaches 0 to carry out the next positioning data operation. If a dwell time is designated, the acceleration is carried out after the designated time elapses.
- (b) In operation by continuous positioning control (operation pattern "01"), the next positioning No. is automatically executed. Always set operation pattern "00" in the last positioning data to terminate the positioning. If the operation pattern is set to positioning continue ("01" or "11"), the operation will continue until operation pattern "00" is found. The operation may be carried out until the max. data item No. 600 if operation pattern "00" cannot be found because it was not set in the last positioning data.

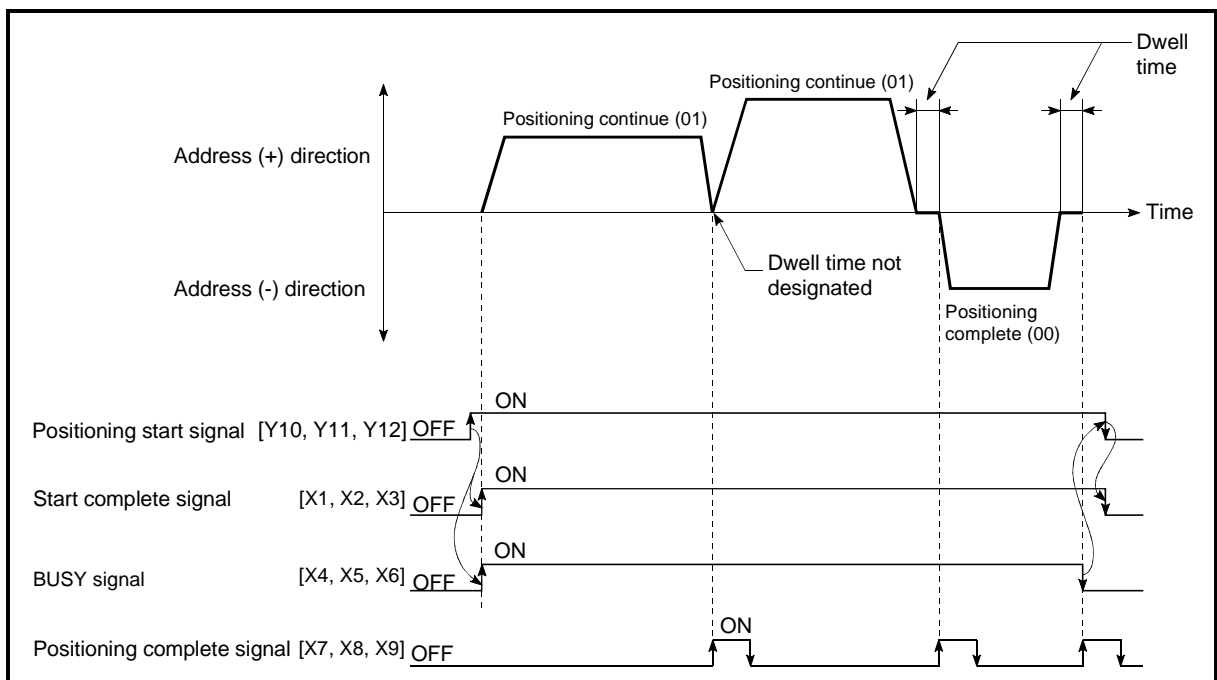
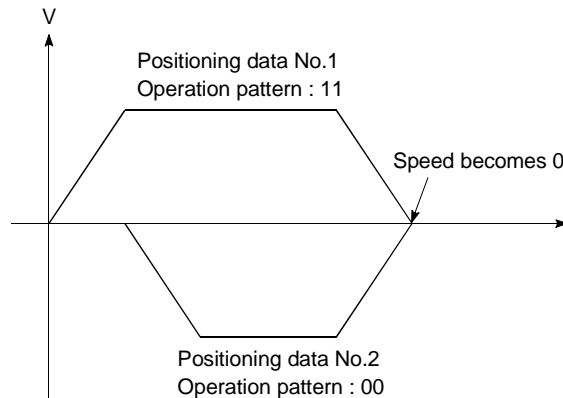

Fig. 9.2 Operation during continuous positioning control

(b) Deceleration stop conditions during continuous path control
 Deceleration stops are not carried out in continuous path control, but the machine will carry out a deceleration stop to speed "0" in the following cases 1) to 4).

- 1) When the operation pattern of the positioning data currently being executed is "continuous path control: 11", and the movement direction of the positioning data currently being executed differs from that of the next positioning data. (Refer to the "Point" below.)



- 2) When the operation pattern of the positioning data currently being executed is "continuous path control: 11", and the movement amount of the next positioning data is "0".
- 3) During operation by step operation. (Refer to section "12.6.1 Step function".)
- 4) When there is an error in the positioning data to carry out the next operation.

POINT
<p>(1) Only the movement direction of the reference axis is checked during interpolation operations Thus, automatic deceleration is not carried out if the movement direction does not change in the reference axis. Because of this, the interpolation axis may suddenly reverse direction. To avoid this sudden direction reversal in the interpolation axis, set the pass point to continuous positioning control "01" instead of setting it to continuous positioning control "11".</p> <div style="display: flex; justify-content: space-around;"> <div style="text-align: center;"> <p>[Positioning by interpolation]</p> </div> <div style="text-align: center;"> <p>[Reference axis operation]</p> </div> <div style="text-align: center;"> <p>[Interpolation axis operation]</p> </div> </div> <p>(2) Automatic deceleration will not be carried out either the positioning data No. currently being executed or the next positioning data No. uses circular interpolation control as a control method.</p>

POINT

(3) When the interpolation axis reverses direction suddenly, the command pulses from AD75 are output as shown in the figure below.

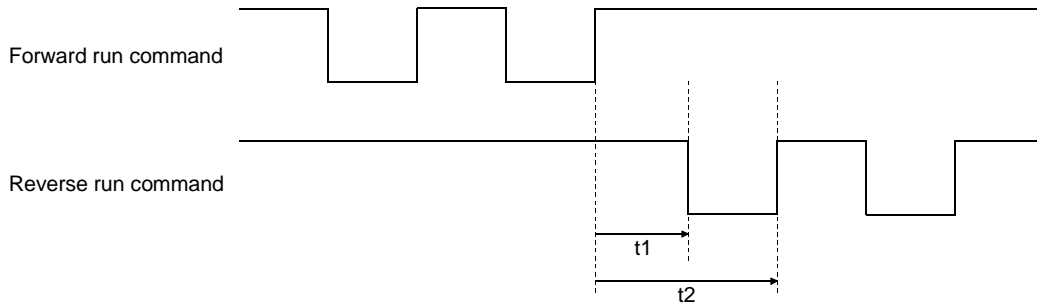

The t1 and t2 are calculated using the following expressions, where a command frequency is f (pps).

$$t1 = 1/2 f (s) \quad t2 = 1/f (s)$$

A time of t1 must be maintained by the drive unit for a specified period T (s).

(T depends on the drive unit specifications.)

If t1 cannot be maintained for T or longer, lower the "Da.7" Command speed" of the positioning data.

(4) In the continuous path control positioning data, assure a movement distance so that the execution time with that data is 100 ms or longer, or lower the command speed.

(c) Speed handling

- 1) Continuous path control command speeds are set with each positioning data.
The AD75 then carries out the positioning at the speed designated with each positioning data.
- 2) The command speed can be set to "-1" in continuous path control. The control will be carried out at the speed used in the previous positioning data No. if the command speed is set to "-1". *1 ("–1" will be displayed in the command speed when the positioning data is set with a peripheral device.)
 - (1) The speed does not need to be set in each positioning data when carrying out uniform speed control if "–1" is set beforehand in the command speed.
 - (2) If the speed is changed in the previous positioning data when "–1" is set in the command speed, the operation can be continued at the new speed.
 - (3) An error "no command speed" (error code: 503) occurs and positioning cannot be started if "–1" is set in the command speed of the first positioning data at start.

[Relation between the command speed and current speed]

*1

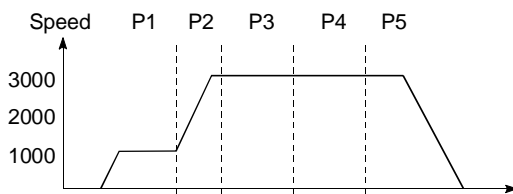

Da. 7	Command speed	1000	3000	-1	-1	-1
Md. 36	Current speed	1000	3000	3000	3000	3000

*2

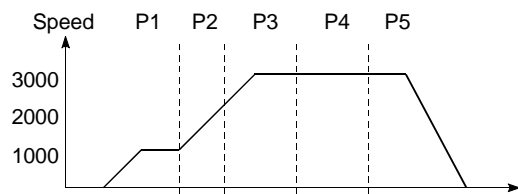

Da. 7	Command speed	1000	3000	-1	-1	-1
Md. 36	Current speed	1000	3000	3000	3000	3000

↑ The current speed is changed even if the command speed is not reached in P2.

POINT

- (1) Speed fluctuation can be eliminated by setting the mode to the near pass mode. (Refer to section "12.3.3 Near pass mode function".)
- (2) The AD75 holds the command speed set with the positioning data as the "Da.7 Command speed", and the latest value of the speed set with the speed change request as the "Md.36 Current speed". It controls the operation at the "Md.36 current speed" when "-1" is set in the command speed. (Depending on the relation between the movement amount and the speed, the feedrate may not reach the command speed value, but even then the current speed will be updated.*2)
- (3) When the address for speed change is identified beforehand, generate and execute the positioning data for speed change by the continuous path control to carry out the speed change without requesting the speed change with a sequence program.

(d) Speed changeover
(Refer to "[Pr.20] Speed changeover mode".)

1) Standard speed changeover mode

- (1) If the respective command speeds differ in the "positioning data currently being executed" and the "positioning data to carry out the next operation", the machine will accelerate or decelerate after reaching the positioning point set in the "positioning data currently being executed" and the speed will change over to the speed set in the "positioning data to carry out the next operation".
- (2) The parameters used in acceleration/deceleration to the command speed set in the "positioning data to carry out the next operation" are those of the positioning data to carry out acceleration/deceleration.
Speed changeover will not be carried out if the command speeds are the same.

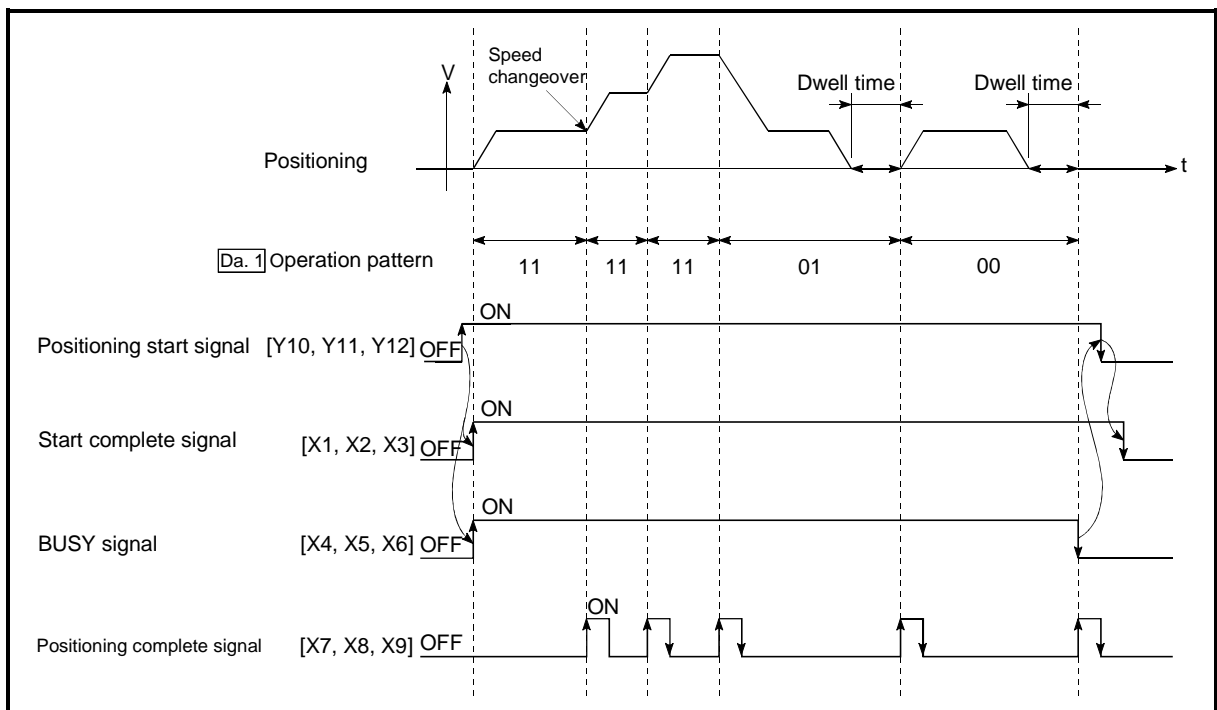
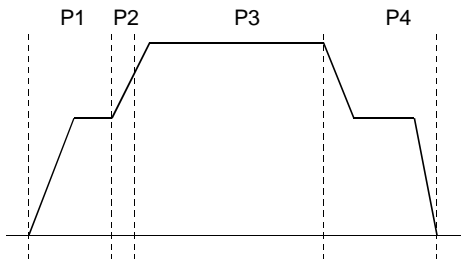

Fig. 9.4 Operation for the standard speed changeover mode

(3) Speed changeover condition

If the movement amount is small in regard to the target speed, the current speed may not reach the target speed even if acceleration/deceleration is carried out. In this case, the machine is accelerated/decelerated so that it nears the target speed. If the movement amount will be exceeded when automatic deceleration is required (Ex. Operation patterns "00", "01"), the machine will immediately stop at the positioning address, and a warning "insufficient movement amount" (warning code: 513) will occur.

[When the speed cannot change over in P2]
 When the relation of the speeds is $P1 = P4, P2 = P3, P1 < P2$.



[When the movement amount is small during automatic deceleration]

The movement amount required to carry out the automatic deceleration cannot be secured, so the machine immediately stops in a speed $\neq 0$ status.

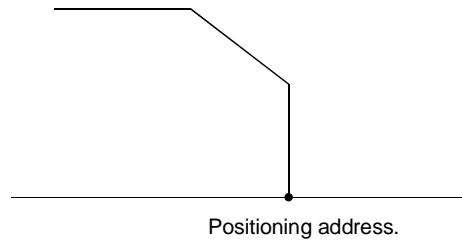

2) Front-loading speed changeover mode

- (1) If the respective command speeds differ in the "positioning data currently being executed" and the "positioning data to carry out the next operation", the speed will change over to the speed set in the "positioning data to carry out the next operation" at the end of the "positioning data currently being executed".
- (2) The parameters used in acceleration/deceleration to the command speed set in the "positioning data to carry out the next operation" are those of the positioning data to carry out acceleration/deceleration. Speed changeover will not be carried out if the command speeds are the same.

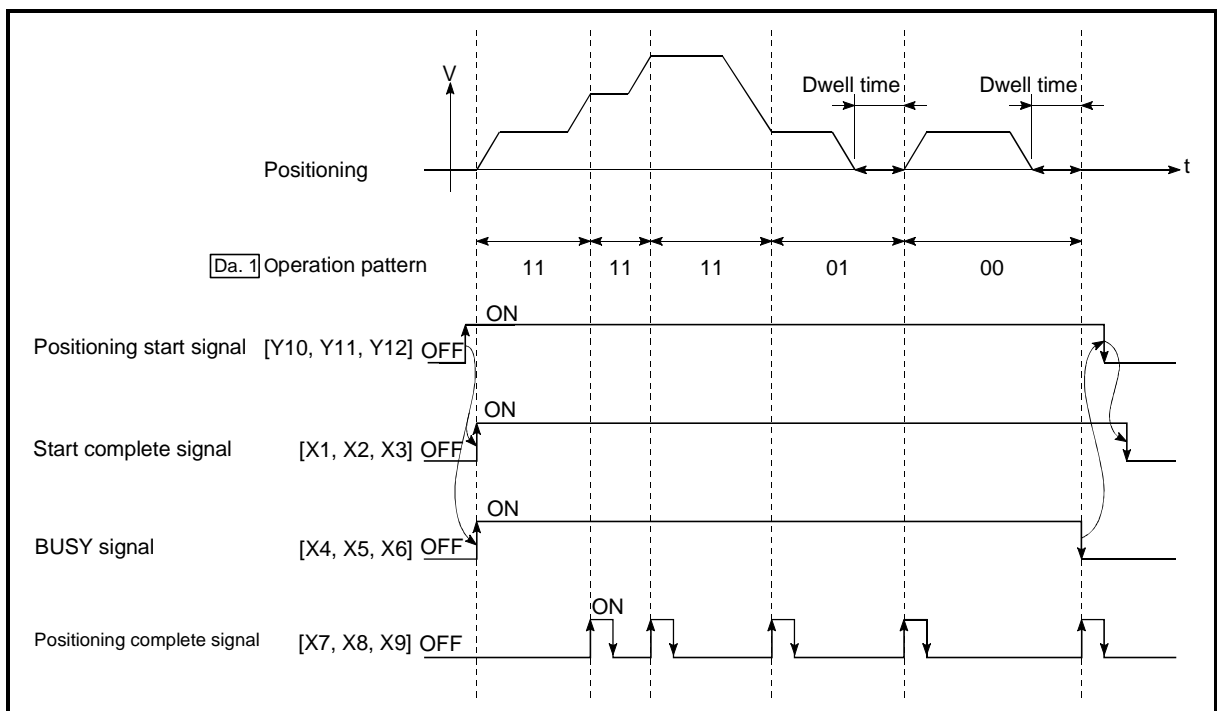

Fig. 9.5 Operation for the front-loading speed changeover mode

(3) Speed changeover condition

If the movement amount is small in regard to the target speed, the current speed may not reach the target speed even if acceleration/deceleration is carried out. In this case, the machine is accelerated/decelerated so that it nears the target speed. If the movement amount will be exceeded when automatic deceleration is required (Ex. Operation patterns "00", "01"), the machine will immediately stop at the positioning address, and a warning "insufficient movement amount" (warning code: 513) will occur.

[When the speed cannot change over to the P2 speed in P1]

When the relation of the speeds is $P1 = P4$, $P2 = P3$, $P1 < P2$.

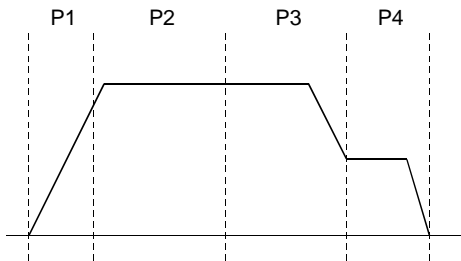

[When the movement amount is small during automatic deceleration]

The movement amount required to carry out the automatic deceleration cannot be secured, so the machine immediately stops in a speed $\neq 0$ status.

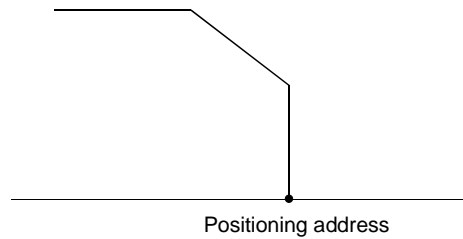

9.1.3 Designating the positioning address

The following shows the two methods for commanding the position in control using positioning data.

■ Absolute system

Positioning is carried out to a designated position (absolute address) having the zero point as a reference. This address is regarded as the positioning address. (The start point can be anywhere.)

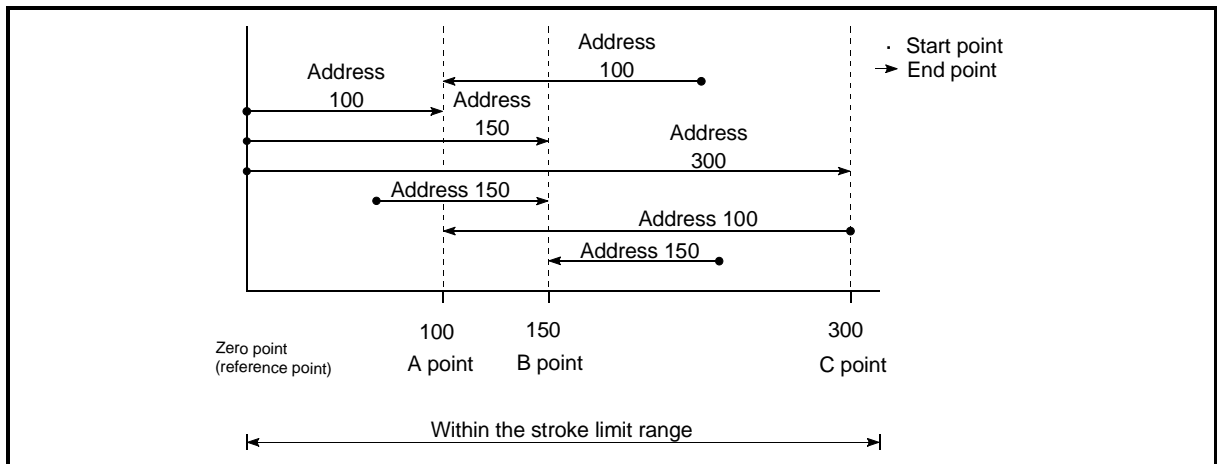

Fig. 9.6 Absolute system positioning

■ Increment system

The position where the machine is currently stopped is regarded as the start point, and positioning is carried out for a designated movement amount in a designated movement direction.

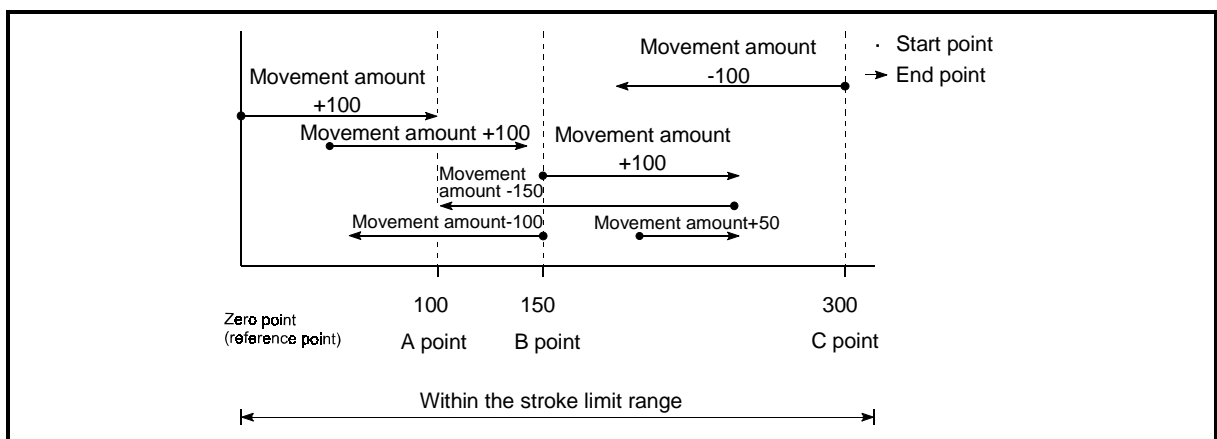

Fig. 9.7 Increment system positioning

9.1.4 Confirming the current value

■ Values showing the current value

The following two types of addresses are used as values to show the position in the AD75.

These addresses ("current feed value" and "machine feed value") are stored in the monitor data area, and used in monitoring the current value display, etc.

Current feed value	<ul style="list-style-type: none"> • This is the value stored in "[Md.29] Current feed value". • This value has an address established with a "machine zero point return" as a reference, but the address can be changed by changing the current value to a new value. • This value is updated every 56. 8ms.
Machine feed value	<ul style="list-style-type: none"> • This is the value stored in "[Md.30] Machine feed value". • This value always has an address established with a "machine zero point return" as a reference. The address cannot be changed, even if the current value is changed to a new value. • This value is updated every 56. 8ms.

The "current feed value" and "machine feed value" are used in monitoring the current value display, etc.

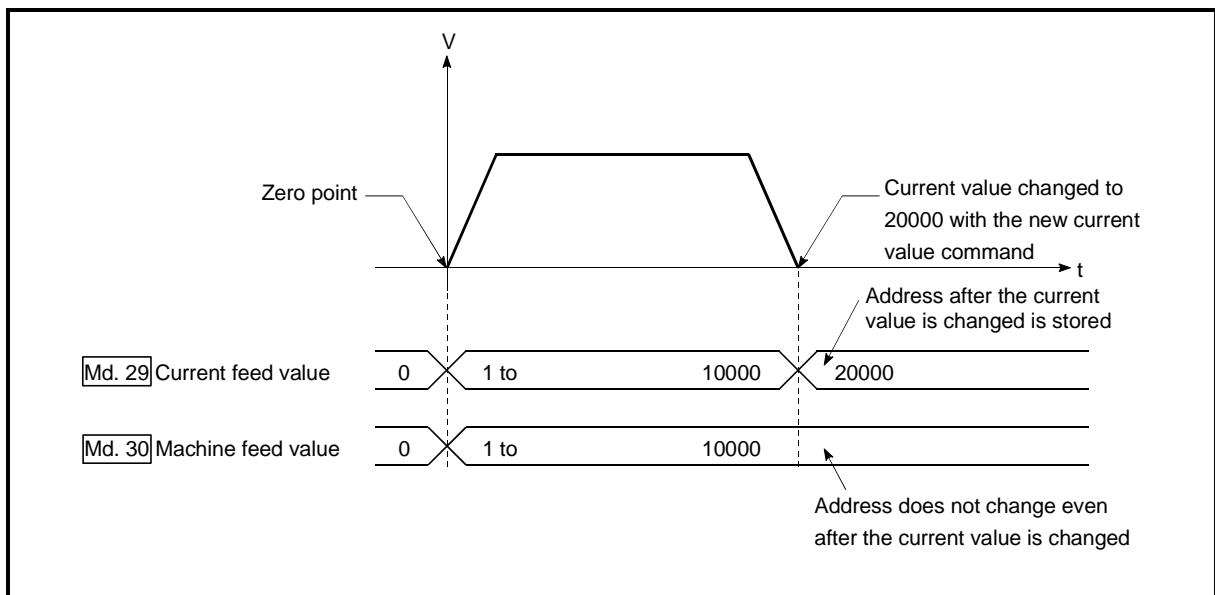

Fig. 9.8 Current feed value and machine feed value

■ Restrictions

- (1) A 56.8ms error will occur in the current value update timing when the stored "current feed value" and "machine feed value" are used in the control.
- (2) The "current feed value" and "machine feed value" may differ from the values set in "[Da.5] Positioning address/movement amount" of the positioning data if the movement amount per pulse is not set to "1".

■ Monitoring the current value

The "current feed value" and "machine feed value" are stored in the following buffer memory addresses, and can be read using a "DFRO (P) command" from the PLC CPU.

	Buffer memory addresses		
	Axis 1	Axis 2	Axis 3
[Md.29] Current feed value	800, 801	900, 901	1000, 1001
[Md.30] Machine feed value	802, 803	902, 903	1002, 1003

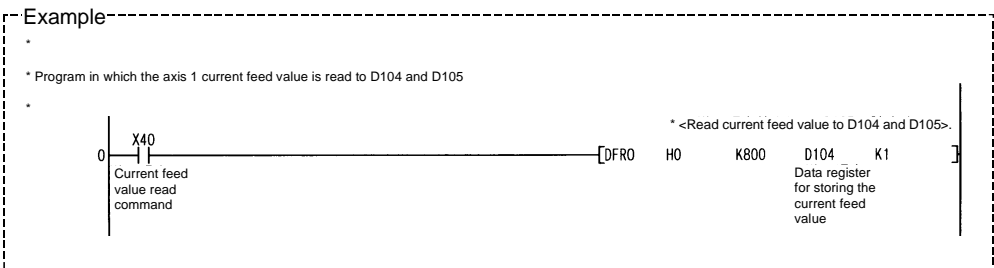

9.1.5 Control unit "degree" handling

When the control unit is set to "degree", the following items differ from when other control units are set.

(1) Current feed value and machine feed value addresses

When the control unit is set to "degree", "[Md.29] Current feed value" becomes the ring address of 0 to 359.99999°.

"[Md.30] Machine feed value" does not become the ring address of 0 to 359.99999°.

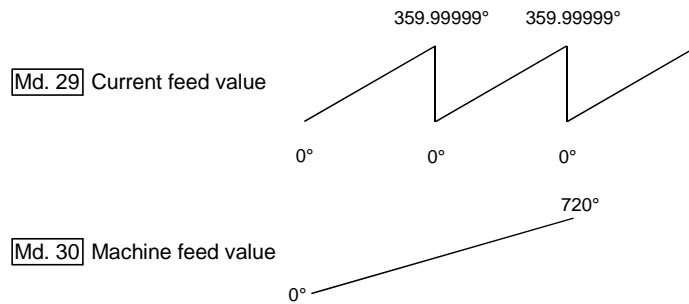

(2) Positioning control method when the control unit is set to "degree"

(a) Absolute system

1) When the software stroke limit is invalid

Positioning is carried out in the nearest direction to the designated address, using the current value as a reference.

(This is called "shortcut control".)

Example

- 1) Positioning is carried out in a clockwise direction when the current value is moved from 315° to 45°.
- 2) Positioning is carried out in a counterclockwise direction when the current value is moved from 45° to 315°.

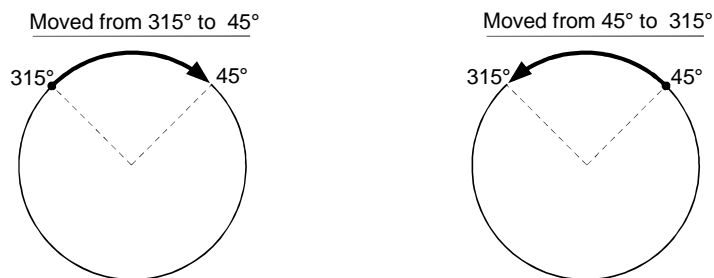

POINT

To make the software stroke limit invalid, set to [Software stroke limit upper limit value = Software stroke limit lower limit value].

2) When the software stroke limit is valid

The positioning is carried out in a clockwise/counterclockwise direction depending on the software stroke limit range setting method.

Because of this, positioning with "shortcut control" may not be possible.

Example

When the current value is moved from 0° to 315°, positioning is carried out in the clockwise direction if the software stroke limit lower limit value is 0° and the upper limit value is 345°.

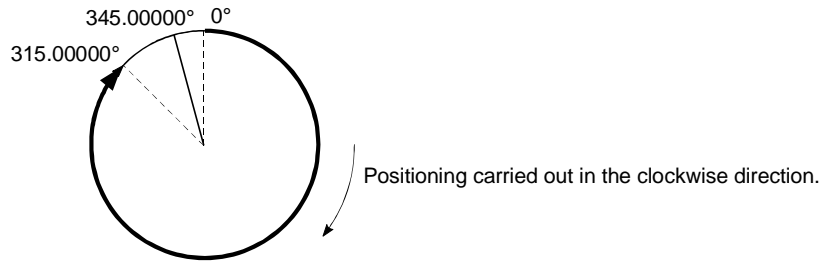

POINT

Positioning addresses are within a range of 0° to 359.99999°.

Use the increment system to carry out positioning of one rotation or more.

(b) Increment system

Positioning is carried out for a designated movement amount in a designated movement direction when in the increment system of positioning.

The movement direction is determined by the sign (+, -) of the movement amount.

- For a positive (+) movement directionClockwise
- For a negative (-) movement directionCounterclockwise

POINT

Positioning of 360° or more can be carried out with the increment system.

At this time, set as shown below to invalidate the software stroke limit.

[Software stroke limit upper limit value = Software stroke limit lower limit value]

9.1.6 Interpolation control

■ Meaning of interpolation control

In "2-axis linear interpolation control", "2-axis fixed-dimension feed control", and "2-axis circular interpolation control", control is carried out so that linear and arc paths are drawn using a motor set in two axis directions. This kind of control is called "interpolation control".

In interpolation control, the axis in which the control method is set is defined as the "reference axis", and the other axis is defined as the "interpolation axis".

The AD75 controls the "reference axis" following the positioning data set in the "reference axis", and controls the "interpolation axis" corresponding to the reference axis control so that a linear or arc path is drawn.

The following table shows the reference axis and interpolation axis combinations. (In case of a 3-axis module)

Axis set to interpolation control in "[Da.2] Control method"	Axis definition	Reference axis	Interpolation axis
Axis 1		Axis 1	Axis 2
Axis 2		Axis 2	Axis 3
Axis 3		Axis 3	Axis 1

*: In case of a 2-axis module, the reference axis is axis 1 and the interpolation axis is axis 2.

■ Setting the positioning data during interpolation control

When carrying out interpolation control, the same positioning data Nos. are set for the "reference axis" and the "interpolation axis".

The following table shows the "positioning data" setting items for the reference axis and interpolation axis.

Setting item	Axis			
	Reference axis setting item	Interpolation axis setting item		
Same positioning data Nos	Da.1	Operation pattern	⊙	—
	Da.2	Control method	Linear 2, Fixed-dimension feed 2, Circular interpolation, Circular right, Circular left	—
	Da.3	Acceleration time No.	⊙	—
	Da.4	Deceleration time No.	⊙	—
	Da.5	Positioning address/movement amount	⊙	○
	Da.6	Arc address	(Only during circular interpolation, right arc, and left arc) △	(Only during circular interpolation, right arc, and left arc) △
	Da.7	Command speed	⊙	—
	Da.8	Dwell time	○	—
	Da.9	M code	○	—

- ⊙ : Setting always required
- : Set according to requirements (Set to "—" when not used.)
- △ : Setting restrictions exist
- : Setting not required (Unrelated setting item, so any setting value will be ignored. Use the initial value or a value within the setting range.)
- * : Refer to section "5.3 List of positioning data" for information on the setting details.

■ Starting the interpolation control

The positioning data Nos. of the reference axis (axis in which interpolation control was set in "[Da.2] Control method") are started when starting the interpolation control. (Starting of the interpolation axis is not required.)

The following errors will occur and the positioning will not start if both reference axis and the interpolation axis are started.

- Reference axis : Interpolation while target axis BUSY (error code: 519)
- Interpolation axis : Control method setting error (error code: 524), start during operation (warning code: 100).

■ Interpolation control continuous positioning

When carrying out interpolation control in which "continuous positioning control" and "continuous path control" are designated in the operation pattern, the positioning method for all positioning data from the started positioning data to the positioning data in which "positioning complete" is set must be set to interpolation control.

The AD75 may malfunction if a control method other than interpolation control is set.

The path pattern can be selected when carrying out "continuous path control" using interpolation control. (Select either the "positioning address mode" or the "near pass mode" is selected. Refer to section "12.3.3 Near pass mode function" for details.)

■ Speed during interpolation control

Either the "composite speed" or "reference axis speed" can be designated as the speed during interpolation control.

(Set in "[Pr.21] Interpolation speed designation method".)

POINT

The speed limit does not function for the speed calculated by the AD75 during interpolation control. Because of this, observe the following precautions when setting the speed.

- When the "composite speed" is set, set a value so the speed for each axis does not exceed the "[Pr.7] Speed limit value".
- When the "reference axis speed" is set, set so the major axis side becomes the reference axis. If the minor axis side is set as the reference axis, the major axis side speed may exceed the "[Pr.7] Speed limit value".

■ Limits to interpolation control

There are limits to the interpolation control that can be executed and speed ([Pr.21] Interpolation speed designation method) that can be set, depending on the "[Pr.1] Unit setting" of the reference axis and interpolation axis. (For example, circular interpolation control cannot be executed if the reference axis and interpolation axis units differ.)

The following table shows the interpolation control and speed designation limits.

"[Da.2] Control method" interpolation control	[Pr.21] Interpolation speed designation method	[Pr.1] Unit setting *1	
		Reference axis and interpolation axis units are the same, or a combination of "mm" and "inch".	Reference axis and interpolation axis units differ *3
Linear 2 (ABS, INC) Fixed-dimension feed 2	Composite speed	○	×
	Reference axis speed	○	○
Circular interpolation (ABS, INC) Right arc (ABS, INC) Left arc (ABS, INC)	Composite speed	○ *2	×
	Reference axis speed	×	×

○ : Setting possible, × : Setting not possible.

*1 "mm" and "inch" unit mix possible.

*2 "degree" setting not possible. An error "control method setting error" (error code: 524) will occur and the position cannot start if circular interpolation control is set when the unit is "degree". The machine will immediately stop if "degree" is set during positioning control.

*3 The unit set in the reference axis will be used for the speed unit during control if the units differ or if "mm" and "inch" are combined.

■ Axis operation status during interpolation control

"In interpolation" will be stored in the "[Md.35] Axis operation status" during interpolation control. "Standing by" will be stored when the interpolation operation is terminated. Both the reference axis and interpolation axis will carry out a deceleration stop if an error occurs during control, and "error occurring" will be stored in the operation status.

9.2 Setting the positioning data

9.2.1 Relation between each control and positioning data

The setting requirements and details for the setting items of the positioning data to be set differ according to the "Da.2 Control method".

The following table shows the positioning data setting items corresponding to the different types of control. Details and settings for the operation of each control are shown in section 9.2.2 and subsequent sections.

(In this section, it is assumed that the positioning data setting is carried out using the AD75 software package.)

Main positioning control		Positioning data setting items	Position control			Speed control	Speed/position changeover control	Other control	
			1-axis linear control 2-axis linear interpolation control	1-axis fixed-dimension feed control 2-axis fixed-dimension feed control	2-axis circular interpolation control			Current value change	JUMP command
Da.1	Operation pattern	Independent positioning control	◎	◎	◎	◎	◎	◎	×
		Continuous positioning control	◎	◎	◎	×	◎	◎	◎
		Continuous path control	◎	×	◎	×	◎	×	◎
Da.2	Control method	Linear 1 Linear 2 *	Fixed-dimension feed1 Fixed-dimension feed 2 *	Circular interpolation Circular right Circular left *	Forward run Speed limited Reverse run Speed limited	Forward run speed/position Reverse run speed/position	Current value change	JUMP command	
Da.3	Acceleration time No.	○	○	○	○	○	-	-	
Da.4	Deceleration time No.	○	○	○	○	○	-	-	
Da.5	Positioning address/movement amount	◎	◎	◎	-	-	Change destination address	-	
Da.6	Arc address	-	-	◎	-	-	-	-	
Da.7	Command speed	◎	◎	◎	◎	◎	-	-	
Da.8	Dwell time	○	○	○	○	○	-	JUMP destination positioning data No.	
Da.9	M code	○	○	○	○	○	-		

◎ : Always set ○ : Set as required ("-" when not set) × : Setting not possible △ : Setting limited
 - : Setting not required (Setting value is invalid. Use the initial values or setting values within a range where no error occurs.)
 * : The "ABS (absolute) method" or "INC (incremental) method" can be used for the control method.

REMARK

- It is recommended that the "positioning data" be set whenever possible with the AD75 software package. Execution by sequence program uses many sequence programs and devices. The execution becomes complicated, and the scan times will increase.
- A "Block transmission" is required when setting No. 101 and subsequent positioning data using a sequence program.

9.2.2 1-axis linear control

In "1-axis linear control" ("Da.2 Control method" = ABS linear 1, INC linear 1), one motor is used to carry out position control in a set axis direction.

(1) 1-axis linear control (ABS linear 1)

■ Operation chart

In absolute system 1-axis linear control, addresses established by a machine zero point return are used. Positioning is carried out from the current stop position (start point address) to the address (end point address) set in "Da.5 Positioning address/movement amount".

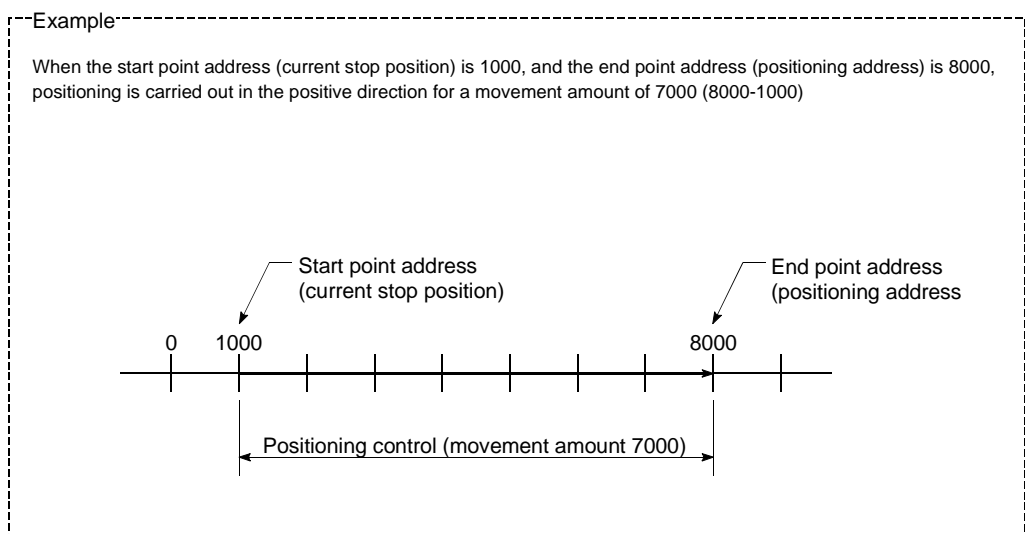

■ Positioning data setting example

The following table shows setting examples when "1-axis linear control (ABS linear 1)" is set in positioning data No. 1 of axis 1.

	Setting item	Setting example	Setting details
Axis 1 Positioning data No. 1	Da.1	Operation pattern	Positioning complete Set "Positioning complete" assuming the next positioning data will not be executed.
	Da.2	Control method	ABS linear 1 Set absolute system 1-axis linear control.
	Da.3	Acceleration time No.	1 Designate the value set in "Pr.26 Acceleration time 1" as the acceleration time at start.
	Da.4	Deceleration time No.	0 Designate the value set in "Pr.9 Deceleration time 0" as the deceleration time at deceleration.
	Da.5	Positioning address/movement amount	8000.0μm Set the positioning address. (Assuming "mm" is set in "Pr.1 Unit setting".)
	Da.6	Arc address	- Setting not required (setting value will be ignored).
	Da.7	Command speed	6000.00mm/min Set the speed during movement to the positioning address.
	Da.8	Dwell time	500ms Set the time the machine dwells after the positioning stop (pulse output stop) to the output of the positioning complete signal.
	Da.9	M code	10 Set this when other auxiliary operation commands are issued in combination with the No. 1 positioning data.

* Refer to section "5.3 List of positioning data" for information on the setting details.

(2) 1-axis linear control (INC linear 1)

■ Operation chart

In increment system 1-axis linear control, addresses established by a machine zero point return are used. Positioning is carried out from the current stop position (start point address) to a position at the end of the movement amount set in "Da.5 Positioning address/movement amount". The movement direction is determined by the sign of the movement amount.

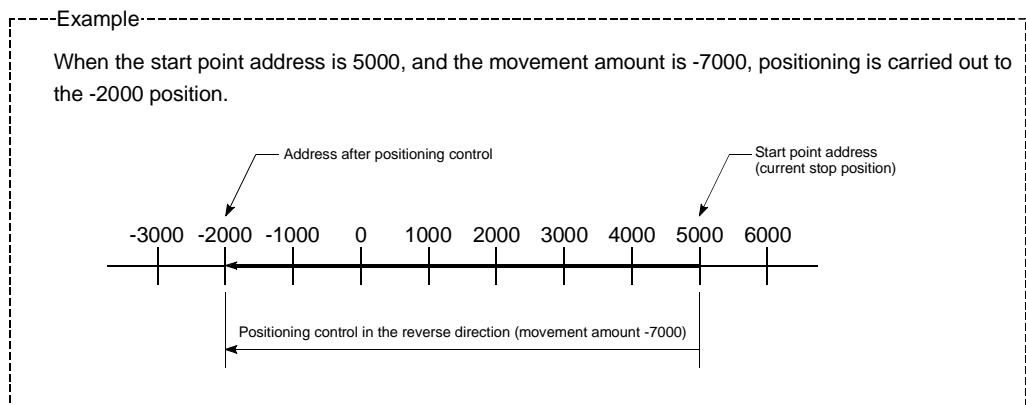

■ Positioning data setting example

The following table shows setting examples when "1-axis linear control (INC linear 1)" is set in positioning data No. 1 of axis 1.

Setting item		Setting example	Setting details
Axis 1 Positioning data No. 1	Da.1	Operation pattern	Positioning complete Set "Positioning complete" assuming the next positioning data will not be executed.
	Da.2	Control method	INC linear 1 Set increment system 1-axis linear control.
	Da.3	Acceleration time No.	1 Designate the value set in "Pr.26 Acceleration time 1" as the acceleration time at start.
	Da.4	Deceleration time No.	0 Designate the value set in "Pr.9 Deceleration time 0" as the deceleration time at deceleration.
	Da.5	Positioning address/movement amount	-7000.0μm Set the movement amount. (Assuming "mm" is set in "Pr.1 Unit setting".)
	Da.6	Arc address	- Setting not required (setting value will be ignored).
	Da.7	Command speed	6000.00mm/min Set the speed during movement.
	Da.8	Dwell time	500ms Set the time the machine dwells after the positioning stop (pulse output stop) to the output of the positioning complete signal.
	Da.9	M code	10 Set this when other auxiliary operation commands are issued in combination with the No. 1 positioning data.

* Refer to section "5.3 List of positioning data" for information on the setting details.

9.2.3 2-axis linear interpolation control

In "2-axis linear interpolation control" ("Da.2 Control method" = ABS linear 2, INC linear 2), two motors are used to carry out position control in a linear path while carrying out interpolation for the axis directions set in each axis.
 (Refer to section "9.1.6 Interpolation control" for details on interpolation control.)

(1) 2-axis linear interpolation control (ABS linear 2)

■ Operation chart

In absolute system 2-axis linear control, addresses established by a machine zero point return on a 2-axis coordinate plane are used. Linear interpolation positioning is carried out from the current stop position (start point address) to the address (end point address) set in "Da.5 Positioning address/movement amount".

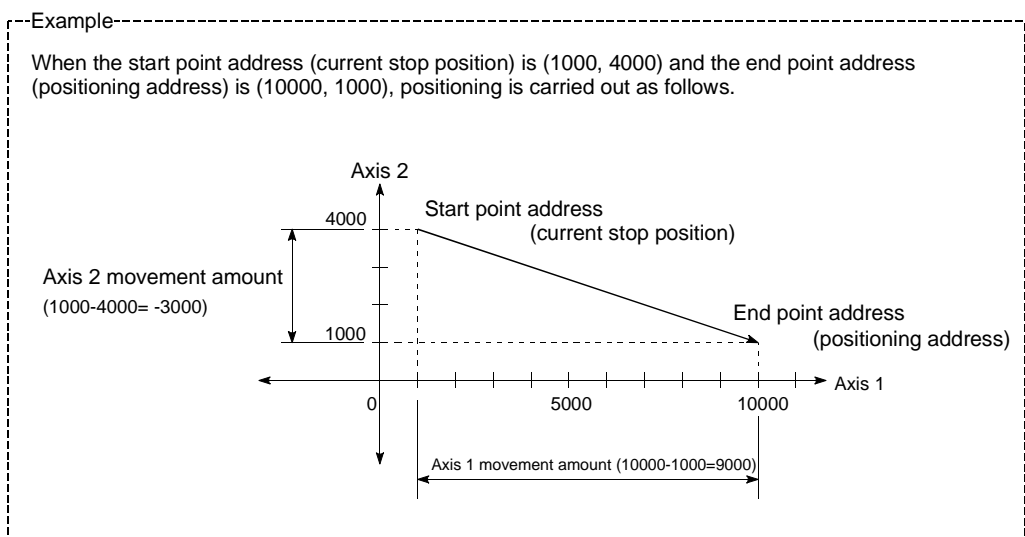
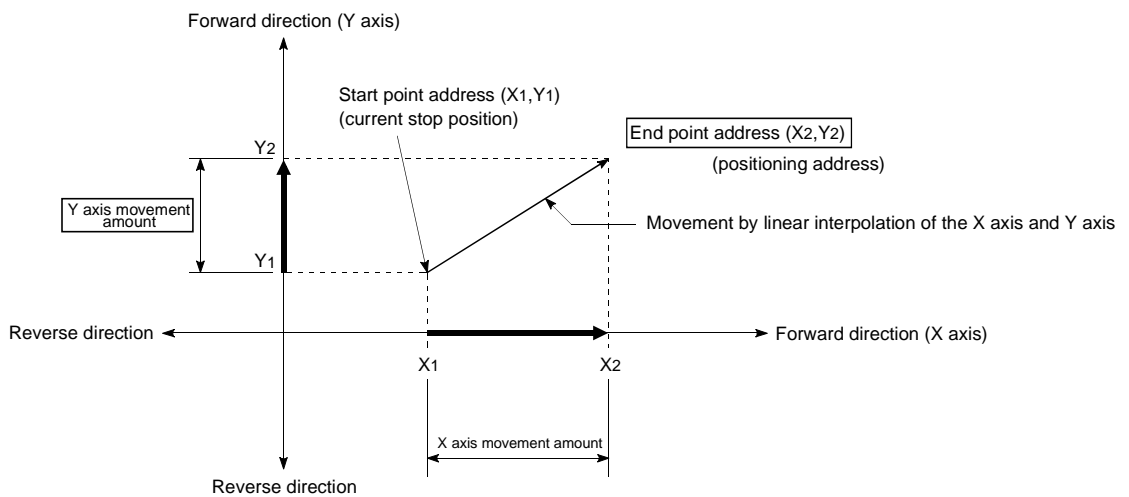

■ Restrictions

An error will occur and the positioning will not start in the following cases. The machine will immediately stop if the error is detected during a positioning control.

- If the movement amount of each axis exceeds "1073741824 (=2³⁰)" at the setting of "0 : Composite speed" in "[Pr.21] Interpolation speed designation method".

An error "outside linear movement amount range" (error code: 504) will occur at the positioning start.

(The maximum movement amount that can be set in "[Da.5] Positioning address/movement amount" is "1073741824 (=2³⁰)")

■ Positioning data setting example

The following table shows setting examples when "2-axis linear interpolation control (ABS linear 2)" is set in positioning data No. 1 of axis 1. (The required values are also set in positioning data No. 1 of axis 2.)

Setting item		Axis		Setting details
		Axis 1 (reference axis) setting example	Axis 2 (interpolation axis) setting example	
Axis 1 Positioning data No. 1	[Da.1] Operation pattern	Positioning complete	–	Set "Positioning complete" assuming the next positioning data will not be executed.
	[Da.2] Control method	ABS linear 2	–	Set absolute system 2-axis linear interpolation control.
	[Da.3] Acceleration time No.	1	–	Designate the value set in "[Pr.26] Acceleration time 1" as the acceleration time at start.
	[Da.4] Deceleration time No.	0	–	Designate the value set in "[Pr.9] Deceleration time 0" as the deceleration time at deceleration.
	[Da.5] Positioning address/movement amount	10000.0 μm	1000.0 μm	Set the end point address. (Assuming "mm" is set in "[Pr.1] Unit setting".)
	[Da.6] Arc address	–	–	Setting not required (setting value will be ignored).
	[Da.7] Command speed	6000.00 mm/min	–	Set the speed during movement to the end point address.
	[Da.8] Dwell time	500ms	–	Set the time the machine dwells after the positioning stop (pulse output stop) to the output of the positioning complete signal.
	[Da.9] M code	10	–	Set this when other auxiliary operation commands are issued in combination with the No. 1 positioning data.

* Refer to section "5.3 List of positioning data" for information on the setting details.

POINT
<p>The speed limit does not function for the speed calculated by the AD75 during interpolation control. Because of this, observe the following precautions when setting the speed.</p> <ul style="list-style-type: none"> • When the "composite speed" is set, set a value so the speed for each axis does not exceed the "[Pr.7] Speed limit value". • When the "reference axis speed" is set, set so the major axis side becomes the reference axis. If the minor axis side is set as the reference axis, the major axis side speed may exceed the "[Pr.7] Speed limit value".

(2) 2-axis linear interpolation control (INC linear 2)

■ Operation chart

In increment system 2-axis linear interpolation control, addresses established by a machine zero point return on a 2-axis coordinate plane are used. Linear interpolation positioning is carried out from the current stop position (start point address) to a position at the end of the movement amount set in "Da.5 Positioning address/movement amount". The movement direction is determined by the sign of the movement amount.

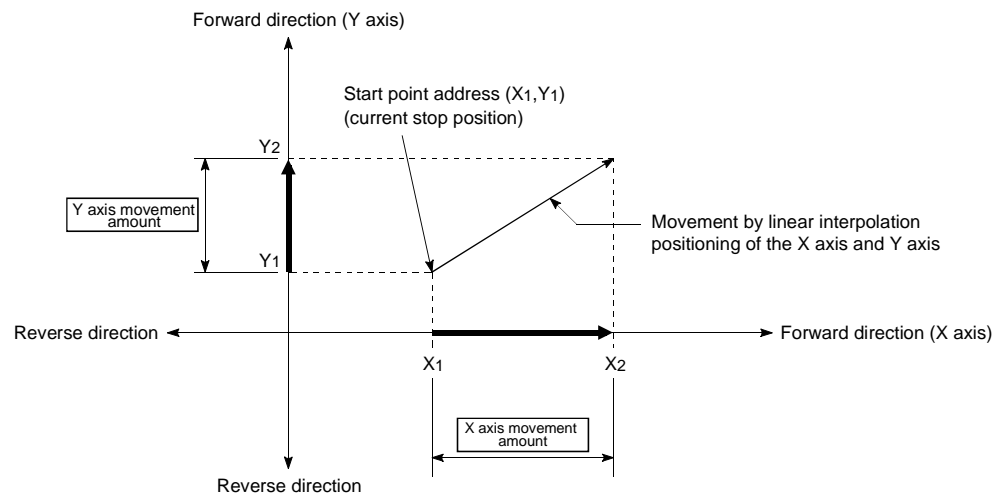

Example

When the axis 1 movement amount is 9000 and the axis 2 movement amount is -3000, positioning is carried out as follows.

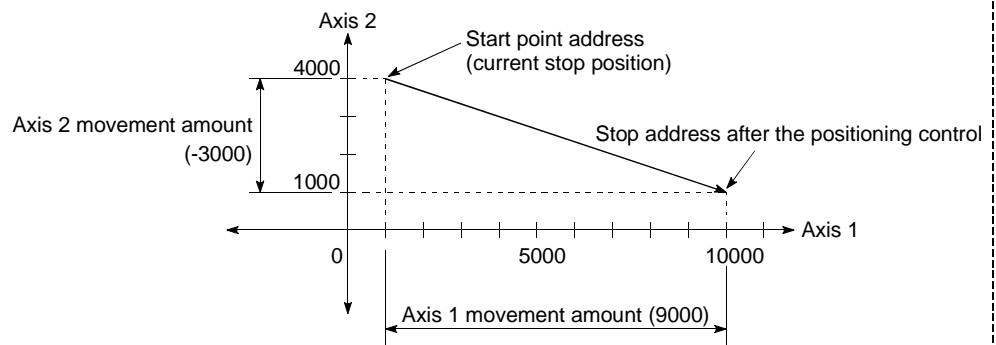

■ Restrictions

An error will occur and the positioning will not start in the following cases. The machine will immediately stop if the error is detected during a positioning operation.

- If the movement amount of each axis exceeds "1073741824 (=2³⁰)" at the setting of "0 : Composite speed" in "[Pr.21] Interpolation speed designation method".

An error "outside linear movement amount range" (error code: 504) will occur at the positioning start.

(The maximum movement amount that can be set in "[Da.5] Positioning address/movement amount" is "1073741824 (=2³⁰)")

■ Positioning data setting example

The following table shows setting examples when "2-axis linear interpolation control (INC linear 2)" is set in positioning data No. 1 of axis 1. (The required values are also set in positioning data No. 1 of axis 2.)

Setting item		Axis	Axis 1 (reference axis) setting example	Axis 2 (interpolation axis) setting example	Setting details
Axis 1 Positioning data No. 1	[Da.1] Operation pattern		Positioning complete	–	Set "Positioning complete" assuming the next positioning data will not be executed.
	[Da.2] Control method		INC linear 2	–	Set increment system 2-axis linear interpolation control.
	[Da.3] Acceleration time No.		1	–	Designate the value set in "[Pr.26] Acceleration time 1" as the acceleration time at start.
	[Da.4] Deceleration time No.		0	–	Designate the value set in "[Pr.9] Deceleration time 0" as the deceleration time at deceleration.
	[Da.5] Positioning address/movement amount		9000.0 μm	-3000.0 μm	Set the movement amount. (Assuming "mm" is set in "[Pr.1] Unit setting".)
	[Da.6] Arc address		–	–	Setting not required (setting value will be ignored).
	[Da.7] Command speed		6000.00 mm/min	–	Set the speed during movement.
	[Da.8] Dwell time		500ms	–	Set the time the machine dwells after the positioning stop (pulse output stop) to the output of the positioning complete signal.
	[Da.9] M code		10	–	Set this when other auxiliary operation commands are issued in combination with the No. 1 positioning data.

* Refer to section "5.3 List of positioning data" for information on the setting details.

POINT
<p>The speed limit does not function for the speed calculated by the AD75 during interpolation control. Because of this, observe the following precautions when setting the speed.</p> <ul style="list-style-type: none"> • When the "composite speed" is set, set a value so the speed for each axis does not exceed the "[Pr.7] Speed limit value". • When the "reference axis speed" is set, set so the major axis side becomes the reference axis. If the minor axis side is set as the reference axis, the major axis side speed may exceed the "[Pr.7] Speed limit value".

9.2.4 1-axis fixed-dimension feed control

In "1-axis fixed-dimension feed control" ("Da.2 Control method" = fixed-dimension feed 1), one motor is used to carry out fixed-dimension feed control in a set axis direction.

In fixed-dimension feed control, any remainder of the movement amount designated in the positioning data is rounded down if less than that required for control accuracy to output the same amount of pulses.

■ Operation chart

In 1-axis fixed-dimension feed control, the address (Md.29 Current feed value) of the current stop position (start point address) is set to "0". Positioning is then carried out to a position at the end of the movement amount set in "Da.5 Positioning address/movement amount".

The movement direction is determined by the movement amount sign.

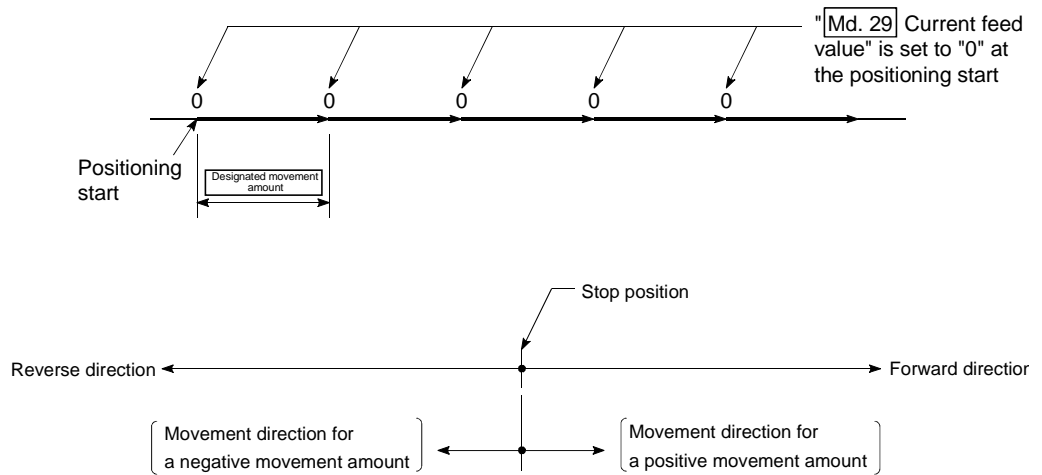

■ Restrictions

- (1) An error "Continuous path control not possible" (error code: 516) will occur and the operation cannot start if "continuous path control" is set in "[Da.1] Operation pattern". ("Continuous path control" cannot be set in fixed-dimension feed control.)
- (2) "Fixed-dimension feed" cannot be set in "[Da.2] Control method" in the positioning data when "continuous path control" has been set in "[Da.1] Operation pattern" of the immediately prior positioning data. (For example, if the operation pattern of positioning data No. 1 is "continuous path control", fixed-dimension feed control cannot be set in positioning data No. 2.) An error "Continuous path control not possible" (error code: 516) will occur and the machine will carry out a deceleration stop if this type of setting is carried out.

■ Positioning data setting example

The following table shows setting examples when "1-axis fixed-dimension feed control (fixed-dimension feed 1)" is set in positioning data No. 1 of axis 1.

	Setting item	Setting example	Setting details
Axis 1 Positioning data No. 1	[Da.1] Operation pattern	Positioning complete	Set "Positioning complete" assuming the next positioning data will not be executed.
	[Da.2] Control method	Fixed-dimension feed 1	Set 1-axis fixed-dimension feed control.
	[Da.3] Acceleration time No.	1	Designate the value set in "[Pr.26] Acceleration time 1" as the acceleration time at start.
	[Da.4] Deceleration time No.	0	Designate the value set in "[Pr.9] Deceleration time 0" as the deceleration time at deceleration.
	[Da.5] Positioning address/movement amount	80000.0μm	Set the positioning address. (Assuming "mm" is set in "[Pr.1] Unit setting".)
	[Da.6] Arc address	–	Setting not required (setting value will be ignored).
	[Da.7] Command speed	6000.00mm/min	Set the speed during movement to the positioning address.
	[Da.8] Dwell time	500ms	Set the time the machine dwells after the positioning stop (pulse output stop) to the output of the positioning complete signal.
	[Da.9] M code	10	Set this when other auxiliary operation commands are issued in combination with the No. 1 positioning data.

* Refer to section "5.3 List of positioning data" for information on the setting details.

9.2.5 2-axis fixed-dimension feed control (interpolation)

In "2-axis fixed-dimension feed control" ("Da.2 Control method" = fixed-dimension feed 2), two motors are used to carry out fixed-dimension feed control in a linear path while carrying out interpolation for the axis directions set in each axis. In fixed-dimension feed control, any remainder of the movement amount designated in the positioning data is rounded down if less than that required for control accuracy to output the same amount of pulses. (The remainder of the movement amount with an accuracy below the control accuracy does not affect the regular controls.) (Refer to section "9.1.6 Interpolation control" for details on interpolation control.)

■ Operation chart

In increment system 2-axis fixed-dimension feed control, the addresses ("Md.29 Current feed value) of the current stop position (start addresses) of both axes are set to "0". Linear interpolation positioning is then carried out from that position to a position at the end of the movement amount set in "Da.5 Positioning address/movement amount". The movement direction is determined by the sign of the movement amount.

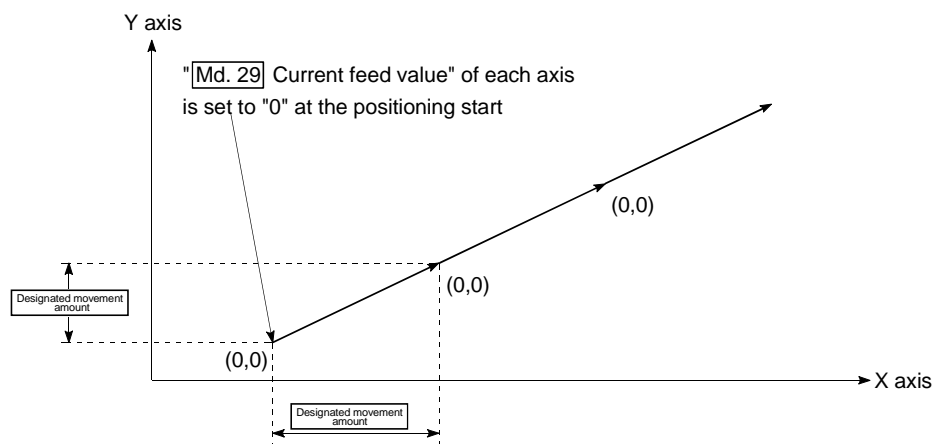

■ Restrictions

- (1) An error "Continuous path control not possible" (error code: 516) will occur and the operation cannot start if "continuous path control" is set in "[Da.1] Operation pattern". ("Continuous path control" cannot be set in fixed-dimension feed control.)
- (2) If the movement amount of each axis exceeds "1073741824 (=2³⁰)" at the setting of "0 : Composite speed" in "[Pr.21] Interpolation speed designation method", an error "outside linear movement amount range" (error code: 504) will occur at a positioning start and positioning cannot be started. (The maximum movement amount that can be set in "[Da.5] Positioning address/movement amount" is "1073741824 (=2³⁰)".)
- (3) "Fixed-dimension feed" cannot be set in "[Da.2] Control method" in the positioning data when "continuous path control" has been set in "[Da.1] Operation pattern" of the immediately prior positioning data. (For example, if the operation pattern of positioning data No. 1 is "continuous path control", fixed-dimension feed control cannot be set in positioning data No. 2.) An error "Continuous path control not possible" (error code: 516) will occur and the machine will carry out a deceleration stop if this type of setting is carried out.

■ Positioning data setting example

The following table shows setting examples when "2-axis fixed-dimension feed control (fixed-dimension feed 2)" is set in positioning data No. 1 of axis 1. (The required values are also set in positioning data No. 1 of axis 2.)

Setting item		Axis		Setting details
		Axis 1 (reference axis) setting example	Axis 2 (interpolation axis) setting example	
Axis 1 Positioning data No. 1	[Da.1] Operation pattern	Positioning complete	—	Set "Positioning complete" assuming the next positioning data will not be executed.
	[Da.2] Control method	Fixed-dimension feed 2	—	Set 2-axis fixed-dimension feed control.
	[Da.3] Acceleration time No.	1	—	Designate the value set in "[Pr.26] Acceleration time 1" as the acceleration time at start.
	[Da.4] Deceleration time No.	0	—	Designate the value set in "[Pr.9] Deceleration time 0" as the deceleration time at deceleration.
	[Da.5] Positioning address/movement amount	80000.0 μm	60000.0 μm	Set the positioning address. (Assuming "mm" is set in "[Pr.1] Unit setting".)
	[Da.6] Arc address	—	—	Setting not required (setting value will be ignored).
	[Da.7] Command speed	6000.00 mm/min	—	Set the speed during movement. (Designate the composite speed of reference axis speed in "[Pr.21] Interpolation speed designation method".)
	[Da.8] Dwell time	500ms	—	Set the time the machine dwells after the positioning stop (pulse output stop) to the output of the positioning complete signal.
	[Da.9] M code	10	—	Set this when other auxiliary operation commands are issued in combination with the No. 1 positioning data.

* Refer to section "5.3 List of positioning data" for information on the setting details.

POINT
<p>The speed limit does not function for the speed calculated by the AD75 during interpolation control. Because of this, observe the following precautions when setting the speed.</p> <ul style="list-style-type: none"> • When the "composite speed" is set, set a value so the speed for each axis does not exceed the "[Pr.7] Speed limit value". • When the "reference axis speed" is set, set so the major axis side becomes the reference axis. If the minor axis side is set as the reference axis, the major axis side speed may exceed the "[Pr.7] Speed limit value".

9.2.6 2-axis circular interpolation control with auxiliary point designation

In "2-axis circular interpolation control" ("Da.2 Control method" = ABS circular interpolation, INC circular interpolation), two motors are used to carry out position control in an arc path passing through designated auxiliary points, while carrying out interpolation for the axis directions set in each axis.
 (Refer to section "9.1.6 Interpolation control" for details on interpolation control.)

(1) 2-axis circular interpolation control with auxiliary point designation (ABS circular interpolation)

■ Operation chart

In the absolute system, 2-axis circular interpolation control with auxiliary point designation, addresses established by a machine zero point return on a 2-axis coordinate plane are used. Positioning is carried out from the current stop position (start point address) to the address (end point address) set in "Da.5 Positioning address/movement amount", in an arc path that passes through the auxiliary point address set in "Da.6 Arc address".

The resulting control path is an arc having as its center the intersection point of perpendicular bisectors of a straight line between the start point address (current stop position) and auxiliary point address (arc address), and a straight line between the auxiliary point address (arc address) and end point address (positioning address).

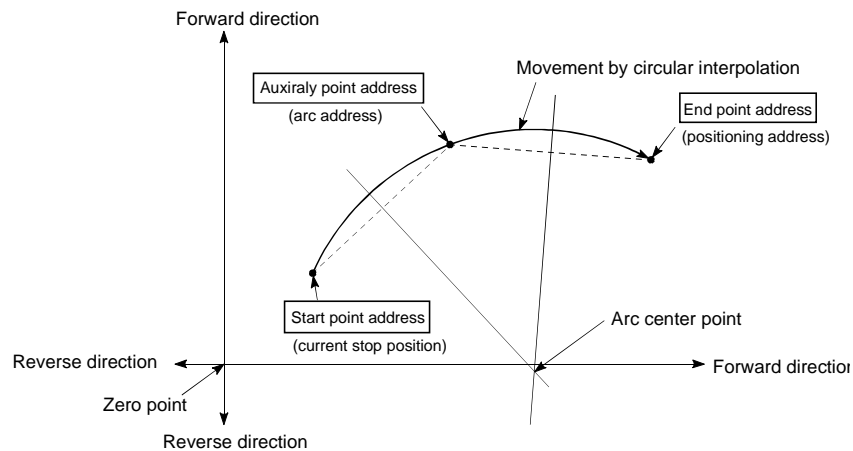

■ Restrictions

- (1) 2-axis circular interpolation control cannot be set in the following cases.
 - When "degree" is set in "[Pr.1] Unit setting"
 - When the units set in "[Pr.1] Unit setting" are different for the reference axis and interpolation axis. ("mm" and "inch" combinations are possible.)
 - When "stepping motor mode" is set in "[Pr.11] Stepping motor mode selection"
 - When "reference axis speed" is set in "[Pr.21] Interpolation speed designation method"
- (2) An error will occur and the positioning start will not be possible in the following cases. The machine will immediately stop if the error is detected during positioning control.
 - When the radius exceeds " $536870912 (2^{29})$ ". (The maximum radius for which circular interpolation control is possible is " $536870912 (2^{29})$ "
 - ... An error "outside radius range" (error code: 544) will occur at positioning start.
 - When the center point address is outside the range of " $-2147483648 (-2^{31})$ to $2147483647 (2^{31}-1)$ "
 - ... An error "auxiliary point setting error" (error code: 525) will occur at positioning start.
 - When the start point address is the same as the end point address
 - ... An error "end point setting error" (error code: 526) will occur.
 - When the start point address is the same as the auxiliary point address
 - ... An error "auxiliary point setting error" (error code: 525) will occur.
 - When the end point address is the same as the auxiliary point address
 - ... An error "auxiliary point setting error" (error code: 525) will occur.
 - When the start point address, auxiliary point address, and end point address are in a straight line
 - ... An error "auxiliary point setting error" (error code: 525) will occur.

■ Positioning data setting example

The following table shows setting examples when "2-axis circular interpolation control with auxiliary point designation (ABS circular interpolation)" is set in positioning data No. 1 of axis 1. (The required values are also set in positioning data No. 1 of axis 2.)

Setting item		Axis		Setting details	
		Axis 1 (reference axis) setting example	Axis 2 (interpolation axis) setting example		
Axis 1 Positioning data No. 1	Da.1	Operation pattern	Positioning complete	–	Set "Positioning complete" assuming the next positioning data will not be executed.
	Da.2	Control method	ABS circular interpolation	–	Set absolute system, 2-axis circular interpolation control with auxiliary point designation.
	Da.3	Acceleration time No.	1	–	Designate the value set in "[Pr.26] Acceleration time 1" as the acceleration time at start.
	Da.4	Deceleration time No.	0	–	Designate the value set in "[Pr.9] Deceleration time 0" as the deceleration time at deceleration.
	Da.5	Positioning address/movement amount	80000.0 μm	60000.0 μm	Set the positioning address. (Assuming "mm" is set in "[Pr.1] Unit setting".)
	Da.6	Arc address	40000.0 μm	30000.0 μm	Set the auxiliary point address. (Assuming that the "[Pr.1] Unit setting" is set to "mm".)
	Da.7	Command speed	6000.00 mm/min	–	Set the speed when moving to the end point address. (Designate the composite speed in "[Pr.21] Interpolation speed designation method".)
	Da.8	Dwell time	500ms	–	Set the time the machine dwells after the positioning stop (pulse output stop) to the output of the positioning complete signal.
	Da.9	M code	10	–	Set this when other auxiliary operation commands are issued in combination with the No. 1 positioning data.

* Refer to section "5.3 List of positioning data" for information on the setting details.

POINT
Set a value in "[Da.7] Command speed" so that the speed of each axis does not exceed the "[Pr.7] Speed limit value". (The speed limit does not function for the speed calculated by the AD75 during interpolation control.)

(2) 2-axis circular interpolation control with auxiliary point designation (INC circular interpolation)

In the increment system, 2-axis circular interpolation control with auxiliary point designation, addresses established by a machine zero point return on a 2-axis coordinate plane are used. Positioning is carried out from the current stop position (start point address) to a position at the end of the movement amount set in "Da.5 Positioning address/movement amount", in an arc path that passes through the auxiliary point address set in "Da.6 Arc address".

The resulting control path is an arc having as its center the intersection point of perpendicular bisectors of the following:

- (1) A straight line between the start point address (current stop position) and auxiliary point address (arc address) calculated from the movement amount to the auxiliary point.
- (2) A straight line between the start auxiliary point address (arc address) and end point address (positioning address) calculated from the movement amount to the end point.

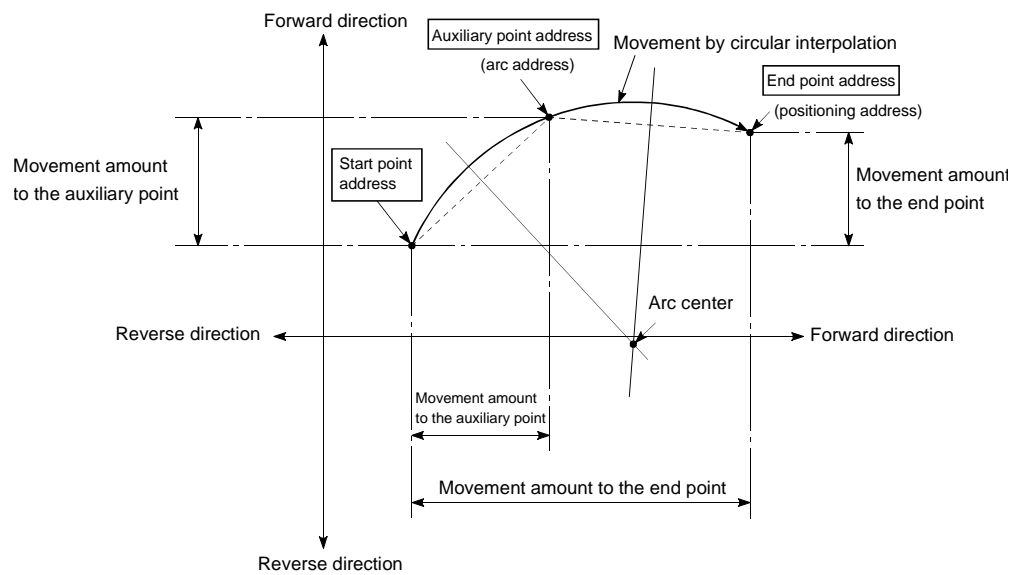

■ Restrictions

- (1) 2-axis circular interpolation control cannot be set in the following cases.
 - When "degree" is set in "[Pr.1] Unit setting"
 - When the units set in "[Pr.1] Unit setting" are different for the reference axis and interpolation axis. ("mm" and "inch" combinations are possible.)
 - When "stepping motor mode" is set in "[Pr.11] Stepping motor mode selection"
 - When "reference axis speed" is set in "[Pr.21] Interpolation speed designation method"
- (2) An error will occur and the positioning start will not be possible in the following cases. The machine will immediately stop if the error is detected during positioning control.
 - In case radius is over than " $536870912(2^{29})$ " which is the maximum and acceptable radius for circular interpolation control, or in case the end address is outside the scope of " $-2147483648(-2^{31})$ to $2147483647(2^{31}-1)$ ".
 - ... An error "end point setting error" (error code:526) or "outside radius range" (error code: 544) will occur at positioning start.
 - When the auxiliary point address or center point address is outside the range of " $-2147483648(-2^{31})$ to $2147483647(2^{31}-1)$ ".
 - ... An error "auxiliary point setting error" (error code: 525) will occur at positioning start.
 - When the start point address is the same as the end point address
 - ... An error "end point setting error" (error code: 526) will occur.
 - When the start point address is the same as the auxiliary point address
 - ... An error "auxiliary point setting error" (error code: 525) will occur.
 - When the end point address is the same as the auxiliary point address
 - ... An error "auxiliary point setting error" (error code: 525) will occur.
 - When the start point address, auxiliary point address, and end point address are in a straight line
 - ... An error "auxiliary point setting error" (error code: 525) will occur.

■ Positioning data setting example

The following table shows setting examples when "2-axis circular interpolation control with auxiliary point designation (INC circular interpolation)" is set in positioning data No. 1 of axis 1. (The required values are also set in positioning data No. 1 of axis 2.)

Setting item		Axis		Setting details	
		Axis 1 (reference axis) setting example	Axis 2 (interpolation axis) setting example		
Axis 1 Positioning data No. 1	Da.1	Operation pattern	Positioning complete	–	Set "Positioning complete" assuming the next positioning data will not be executed.
	Da.2	Control method	INC circular interpolation	–	Set increment system, 2-axis circular interpolation control with auxiliary point designation.
	Da.3	Acceleration time No.	1	–	Designate the value set in " Pr.26 Acceleration time 1" as the acceleration time at start.
	Da.4	Deceleration time No.	0	–	Designate the value set in " Pr.9 Deceleration time 0" as the deceleration time at deceleration.
	Da.5	Positioning address/movement amount	80000.0 μm	60000.0 μm	Set the movement amount. (Assuming that the " Pr.1 Unit setting" is set to "mm".)
	Da.6	Arc address	40000.0 μm	30000.0 μm	Set the auxiliary point address. (Assuming that the " Pr.1 Unit setting" is set to "mm".)
	Da.7	Command speed	6000.00 mm/min	–	Set the speed during movement. (Designate the composite speed in " Pr.21 Interpolation speed designation method".)
	Da.8	Dwell time	500ms	–	Set the time the machine dwells after the positioning stop (pulse output stop) to the output of the positioning complete signal.
	Da.9	M code	10	–	Set this when other auxiliary operation commands are issued in combination with the No. 1 positioning data.

* Refer to section "5.3 List of positioning data" for information on the setting details.

POINT
Set a value in " Da.7 Command speed" so that the speed of each axis does not exceed the " Pr.7 Speed limit value". (The speed limit does not function for the speed calculated by the AD75 during interpolation control.)

9.2.7 2-axis circular interpolation control with center point designation

In "2-axis circular interpolation control" ("Da.2 Control method" = ABS right arc, INC right arc, ABS left arc, INC left arc), two motors are used to carry out position control in an arc path having a designated center point, while carrying out interpolation for the axis directions set in each axis.

(Refer to section "9.1.6 Interpolation control" for details on interpolation control.)

The following table shows the rotation directions, arc center angles that can be controlled, and positioning paths for the different control methods.

Control method	Rotation direction	Arc center angle that can be controlled	Positioning path
ABS right arc	Clockwise	$0^\circ < \theta \leq 360^\circ$	
INC right arc			
ABS left arc	Counterclockwise		
INC left arc			

■ Circular interpolation error compensation

In circular interpolation control with center point designation, the arc path calculated from the start point address and arc address may deviate from the position of the end point address set in "[Da.5] Positioning address/movement amount".

(Refer to "[Pr.42] Allowable circular interpolation error width".)

- (1) Calculated error \leq "[Pr.42] Allowable circular interpolation error width"

Circular interpolation control to the set end point address is carried out while the error compensation is carried out. (This is called "spiral interpolation".)

- (2) Calculated error $>$ "[Pr.42] Allowable circular interpolation error width"

At the positioning start, an error "large arc error deviation" (error code: 506) will occur and the control will not start. The machine will immediately stop if the error is detected during positioning control.

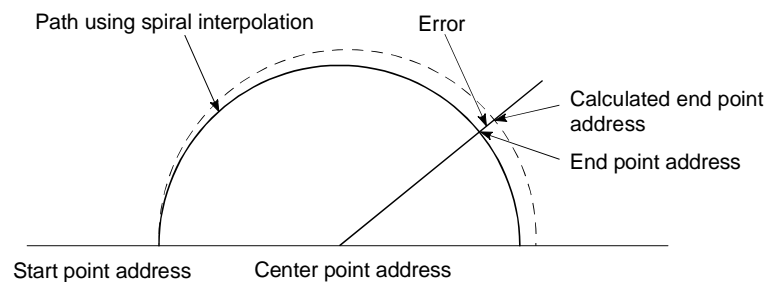

During arc interpolation control with center point designation, the angle is calculated on the assumption that movement at the command speed occurs on an arc drawn in the radius calculated from the start point and center point addresses, and the radius is corrected in proportion to the angular velocity from the start point.

Therefore, if there is difference between the radius (radius at start point) calculated from the start point and center point addresses and the radius (radius at end point) calculated from the end point and center point addresses, the resultant velocity has the following tendency, different from the command speed.

- If the radius at the start point is larger than that at the end point:
The velocity becomes slower as the end point address draws nearer when compared with the case including no error.
- If the radius at the start point is smaller than that at the end point:
The velocity becomes faster as the end point address draws nearer when compared with the case including no error.

(1) 2-axis circular interpolation control with center point designation
(ABS right arc, ABS left arc)

■ Operation chart

In the absolute system, 2-axis circular interpolation control with center point designation, addresses established by a machine zero point return on a 2-axis coordinate plane are used. Positioning is carried out from the current stop position (start point address) to the address (end point address) set in "Da.5 Positioning address/movement amount", in an arc path having as its center the address (arc address) of the center point set in "Da.6 Arc address".

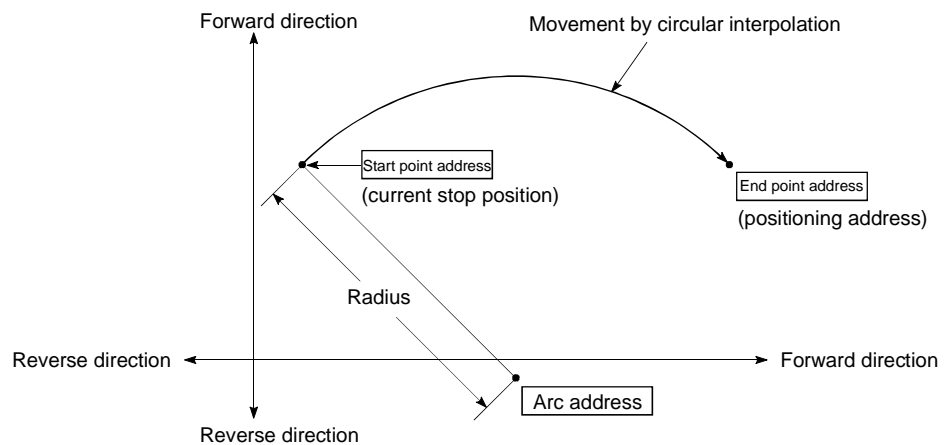

Positioning of a complete round with a radius from the start point address to the arc center point can be carried out by setting the end point address (positioning address) to the same address as the start point address.

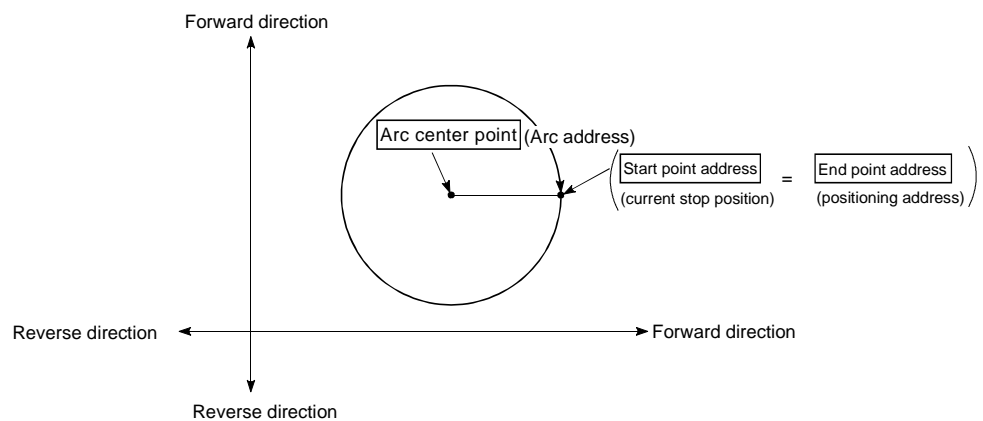

■ Restrictions

- (1) 2-axis circular interpolation control cannot be set in the following cases.
 - When "degree" is set in "[Pr.1] Unit setting"
 - When the units set in "[Pr.1] Unit setting" are different for the reference axis and interpolation axis. ("mm" and "inch" combinations are possible.)
 - When "stepping motor mode" is set in "[Pr.11] Stepping motor mode selection"
 - When "reference axis speed" is set in "[Pr.21] Interpolation speed designation method"
- (2) An error will occur and the positioning start will not be possible in the following cases. The machine will immediately stop if the error is detected during positioning control.
 - When the radius exceeds "536870912 (2²⁹)". (The maximum radius for which circular interpolation control is possible is "536870912 (2²⁹)"
 ... An error "outside radius range" (error code: 544) will occur at positioning start.
 - When the start point address is the same as the center point address
 ... An error "center point setting error" (error code: 527) will occur.
 - When the end point address is the same as the center point address
 ... An error "center point setting error" (error code: 527) will occur.

■ Positioning data setting examples

The following table shows setting examples when "2-axis circular interpolation control with center point designation (ABS right arc, ABS left arc)" is set in positioning data No. 1 of axis 1. (The required values are also set in positioning data No. 1 of axis 2.)

Setting item		Axis	Axis 1 (reference axis) setting example	Axis 2 (interpolation axis) setting example	Setting details
		Axis 1			
Axis 1 Positioning data No. 1	[Da.1]	Operation pattern	Positioning complete	–	Set "Positioning complete" assuming the next positioning data will not be executed.
	[Da.2]	Control method	ABS right arc ABS left arc	–	Set absolute system, 2-axis circular interpolation control with center point designation. (Select clockwise or counterclockwise according to the control.)
	[Da.3]	Acceleration time No.	1	–	Designate the value set in "[Pr.26] Acceleration time 1" as the acceleration time at start.
	[Da.4]	Deceleration time No.	0	–	Designate the value set in "[Pr.9] Deceleration time 0" as the deceleration time at deceleration.
	[Da.5]	Positioning address/movement amount	80000.0 μm	60000.0 μm	Set the positioning address. (Assuming "mm" is set in "[Pr.1] Unit setting".)
	[Da.6]	Arc address	40000.0 μm	30000.0 μm	Set the arc address. (Assuming that the "[Pr.1] Unit setting" is set to "mm".)
	[Da.7]	Command speed	6000.00 mm/min	–	Set the speed when moving to the end point address. (Designate the composite speed in "[Pr.21] Interpolation speed designation method".)
	[Da.8]	Dwell time	500ms	–	Set the time the machine dwells after the positioning stop (pulse output stop) to the output of the positioning complete signal.
	[Da.9]	M code	10	–	Set this when other auxiliary operation commands are issued in combination with the No. 1 positioning data.

* Refer to section "5.3 List of positioning data" for information on the setting details.

POINT
Set a value in "Da.7 Command speed" so that the speed of each axis does not exceed the "Pr.7 Speed limit value". (The speed limit does not function for the speed calculated by the AD75 during interpolation control.)

(2) 2-axis circular interpolation control with center point designation (INC right arc, INC left arc)

■ Operation chart

In the increment system, 2-axis circular interpolation control with center point designation, addresses established by a machine zero point return on a 2-axis coordinate plane are used. Positioning is carried out from the current stop position (start point address) to a position at the end of the movement amount set in "Da.5 Positioning address/movement amount", in an arc path having as its center the address (arc address) of the center point set in "Da.6 Arc address".

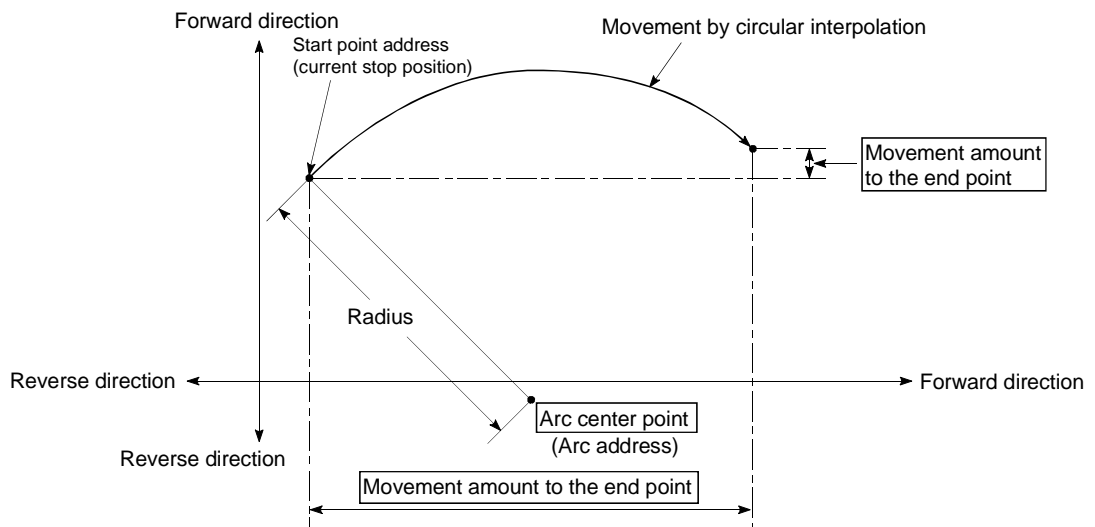

Positioning of a complete round with a radius of the distance from the start point address to the arc center point can be carried out by setting the movement amount to "0".

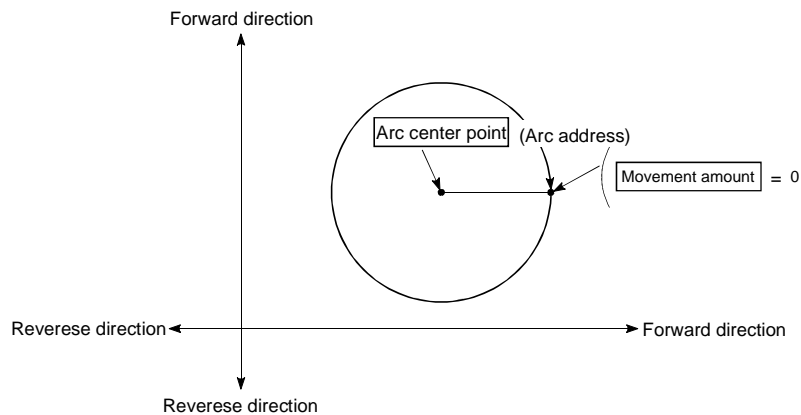

In circular interpolation control with center point designation, an angular velocity is calculated on the assumption that operation is carried out at a command speed on the arc using the radius calculated from the start point address and center point address, and the radius is compensated in proportion to the angular velocity deviated from that at the start point.

Thus, when there is a difference (error) between a radius calculated from the start point address and center point address (start point radius) and a radius calculated from the end point address and center point address (end point radius), the composite speed differs from the command speed as follows.

- * Start point radius > End point radius: As compared with the speed without error, the speed becomes slower as end point address is reached.
- * Start point radius < End point radius: As compared with the speed without error, the speed becomes faster as end point address is reached.

■ Restrictions

- (1) 2-axis circular interpolation control cannot be set in the following cases.
 - When "degree" is set in "[Pr.1] Unit setting"
 - When the units set in "[Pr.1] Unit setting" are different for the reference axis and interpolation axis. ("mm" and "inch" combinations are possible.)
 - When "stepping motor mode" is set in "[Pr.11] Stepping motor mode selection"
 - When "reference axis speed" is set in "[Pr.21] Interpolation speed designation method"
- (2) An error will occur and the positioning start will not be possible in the following cases. The machine will immediately stop if the error is detected during positioning control.
 - In case radius is over than " $536870912(=2^{29})$ " which is the maximum and acceptable radius for circular interpolation control, or in case the end address is outside the scope of " $-2147483648(-2^{31})$ to $2147483647(2^{31}-1)$ ".
 - ... An error "end point setting error" (error code:526) or "outside radius range" (error code: 544) will occur at positioning start.
 - When the start point address is the same as the center point address
 - ... An error "center point setting error" (error code: 527) will occur.
 - When the end point address is the same as the center point address
 - ... An error "center point setting error" (error code: 527) will occur.

■ Positioning data setting examples

The following table shows setting examples when "2-axis circular interpolation control with center point designation (INC right arc, INC left arc)" is set in positioning data No. 1 of axis 1. (The required values are also set in positioning data No. 1 of axis 2.)

Setting item		Axis		Setting details	
		Axis 1 (reference axis) setting example	Axis 2 (interpolation axis) setting example		
Axis 1 Positioning data No. 1	Da.1	Operation pattern	Positioning complete	–	Set "Positioning complete" assuming the next positioning data will not be executed.
	Da.2	Control method	INC right arc INC left arc	–	Set increment system, 2-axis circular interpolation control with center point designation. (Select clockwise or counterclockwise according to the control.)
	Da.3	Acceleration time No.	1	–	Designate the value set in "Pr.26 Acceleration time 1" as the acceleration time at start.
	Da.4	Deceleration time No.	0	–	Designate the value set in "Pr.9 Deceleration time 0" as the deceleration time at deceleration.
	Da.5	Positioning address/movement amount	80000.0 μm	60000.0 μm	Set the movement amount. (Assuming that the "Pr.1 Unit setting" is set to "mm".)
	Da.6	Arc address	40000.0 μm	30000.0 μm	Set the center point address. (Assuming that the "Pr.1 Unit setting" is set to "mm".)
	Da.7	Command speed	6000.00 mm/min	–	Set the speed when moving to the end point address. (Designate the composite speed in "Pr.21 Interpolation speed designation method".)
	Da.8	Dwell time	500ms	–	Set the time the machine dwells after the positioning stop (pulse output stop) to the output of the positioning complete signal.
	Da.9	M code	10	–	Set this when other auxiliary operation commands are issued in combination with the No. 1 positioning data.

* Refer to section "5.3 List of positioning data" for information on the setting details.

POINT
Set a value in "Da.7 Command speed" so that the speed of each axis does not exceed the "Pr.7 Speed limit value". (The speed limit does not function for the speed calculated by the AD75 during interpolation control.)

9.2.8 Speed control

In "speed control" ("Da.2 Control method" = Forward run: speed control, Reverse run: speed control), control is carried out in the axis direction in which the positioning data has been set by continuously outputting pulses for the speed set in "Da.7 Command speed" until the input of a stop command.

The two types of speed control are "Forward run: speed control" in which the control starts in the forward run direction, and "Reverse run: speed control" in which control starts in the reverse run direction.

■ Operation chart

The following chart shows the operation timing for speed control. The "in speed control flag" (Md.40 Status: b0) is turned ON during speed control.

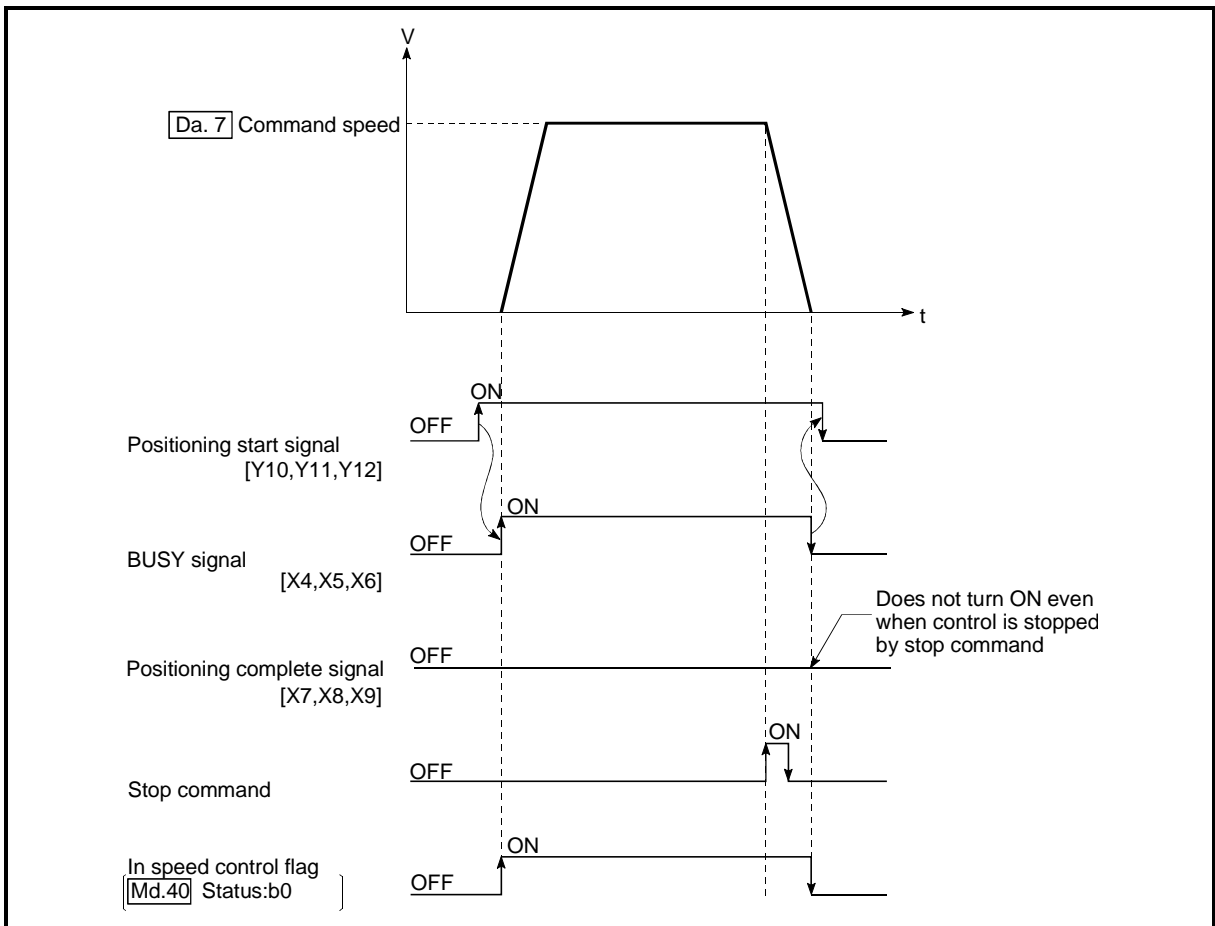
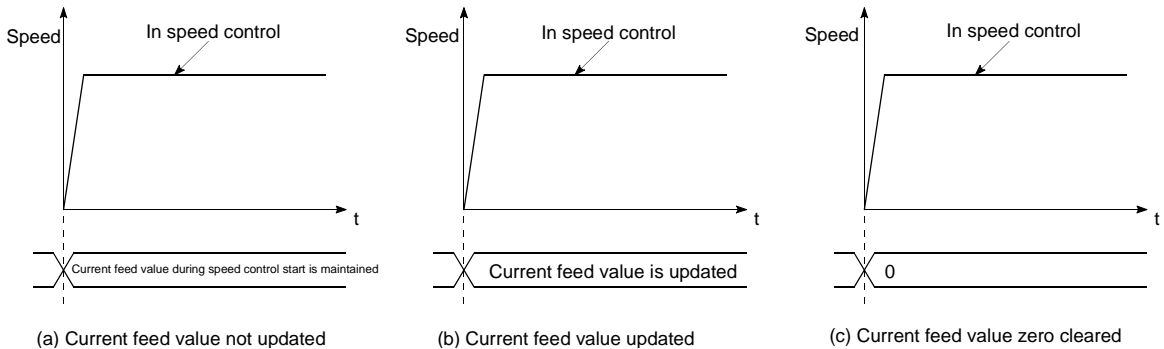

Fig. 9.9 Speed control operation timing

■ Current feed value during speed control

The following table shows the "Md.29 Current feed value" during speed control corresponding to the "Pr.22 Current feed value during speed control" settings.

"Pr.22 Current feed value during speed control" setting	Md.29 Current feed value
0: Do not update current feed value	The current feed value during speed control start is maintained.
1: Update current feed value	The current feed value is updated.
2: Zero clear current feed value	The current feed value is fixed at 0.



■ Restrictions

- Set "Positioning complete" for "Da.1 Operation pattern." If "continuous positioning control" or "continuous path control" is selected, an error "continuous path control not possible" (error code: 516) occurs, resulting in a failure to start. (In the speed control mode, "continuous positioning control" or "continuous path control" cannot be selected.)
- To use M codes, set the "WITH" mode for "Pr.19 M code ON signal output timing." If the "AFTER" mode is selected, the M codes are not output and the "M code ON" signal does not turn ON.
- The software stroke limit check is not made with the "degree" unit.

■ Positioning data setting examples

The following table shows setting examples when "speed control (forward run: speed control)" is set in positioning data No. 1 of axis 1.

	Setting item	Setting example	Setting details
Positioning data No. 1	Da.1 Operation pattern	Positioning complete	Setting other than "Positioning complete" is not possible in speed control.
	Da.2 Control method	Forward run: speed control	Set speed control.
	Da.3 Acceleration time No.	1	Designate the value set in "Pr.26 Acceleration time 1" as the acceleration time at start.
	Da.4 Deceleration time No.	0	Designate the value set in "Pr.9 Deceleration time 0" as the deceleration time at deceleration.
	Da.5 Positioning address/movement amount	-	Setting not required. (Setting value is ignored.)
	Da.6 Arc address	-	Setting not required. (Setting value is ignored.)
	Da.7 Command speed	6000.00mm/min	Set the speed to be commanded.
	Da.8 Dwell time	-	Setting not required. (Setting value is ignored.)
	Da.9 M code	10	Set this when other auxiliary operation commands are issued in combination with the No. 1 positioning data. ("Pr.19 M code ON signal output timing" setting only possible in the WITH mode.)

* Refer to section "5.3 List of positioning data" for information on the setting details.

9.2.9 Speed/position changeover control

In "speed/position changeover control" ("Da.2 Control method" = Forward run: speed/position, Reverse run: speed/position), position control is carried out for the movement amount set in "Da.5 Positioning address/movement amount", in the axis direction in which the positioning data has been set. The position control is carried out by continuously outputting pulses for the speed set in "Da.7 Command speed" until the input of a stop command, and inputting a "speed/position changeover signal". The two types of speed/position changeover control are "Forward run: speed/position" in which the control starts in the forward run direction, and "Reverse run: speed/position" in which control starts in the reverse run direction.

■ Changing over from speed control to position control

- (1) The control is changed over from speed control to position control by the external signal "speed/position changeover signal".
- (2) Besides setting the positioning data, the "Cd.20 Speed/position changeover enable flag" must also be turned ON to change over from speed control to position control. (If the "Cd.20 Speed/position changeover enable flag" turns ON after the speed/position changeover signal turns ON, the control will continue as speed control without changing over to position control. Only position control will be carried out when the "Cd.20 Speed/position changeover enable flag" and speed/position changeover signal are ON at the operation start.)

■ Operation chart

The following chart (Fig.9.10) shows the operation timing for speed/position changeover control. The "in speed control flag" (Md.40 Status: b0) is turned ON during speed control of speed/position changeover control.

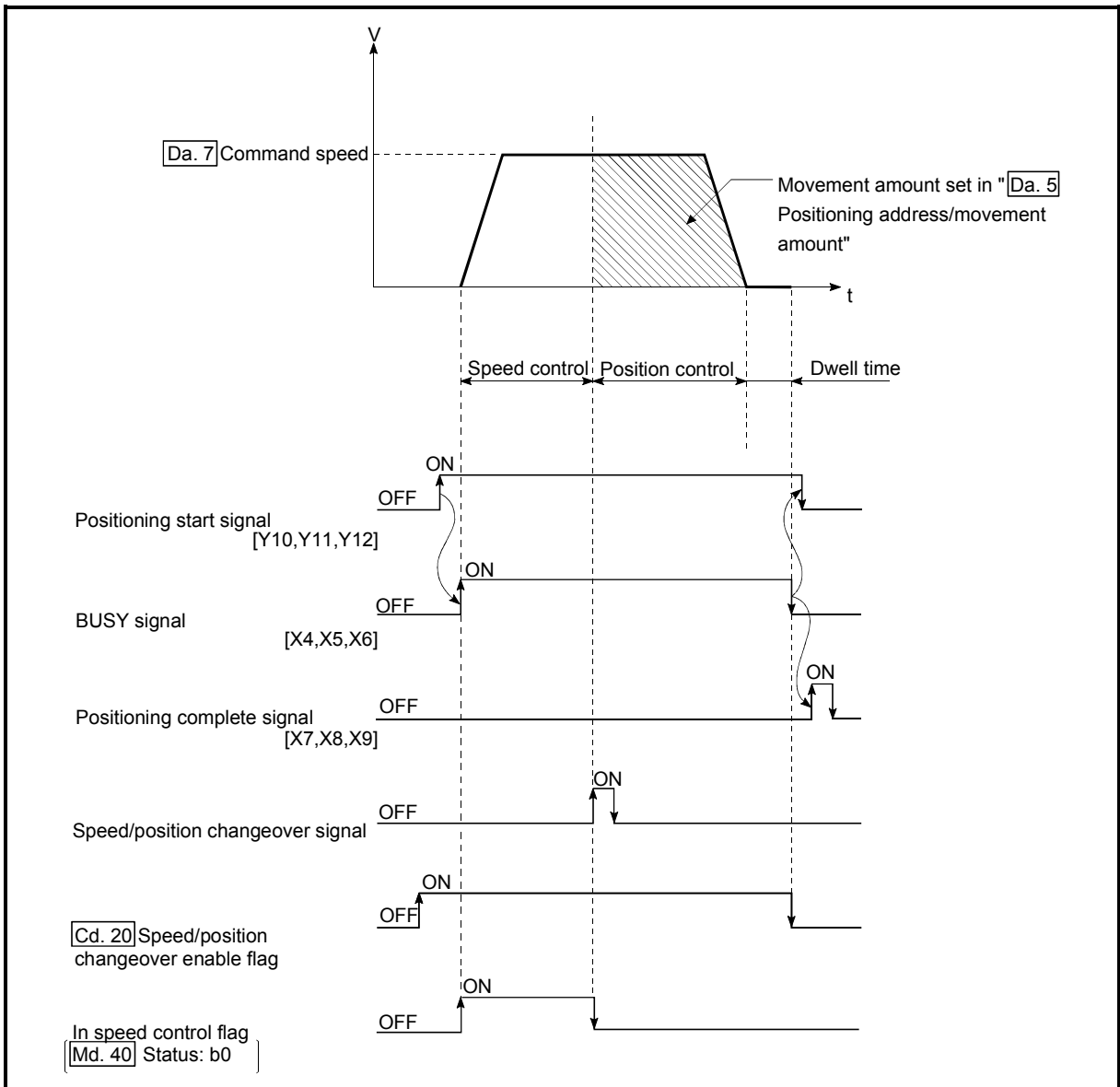

Fig. 9.10 Speed/position changeover control operation timing

■ Operation timing and processing time during speed/position changeover control

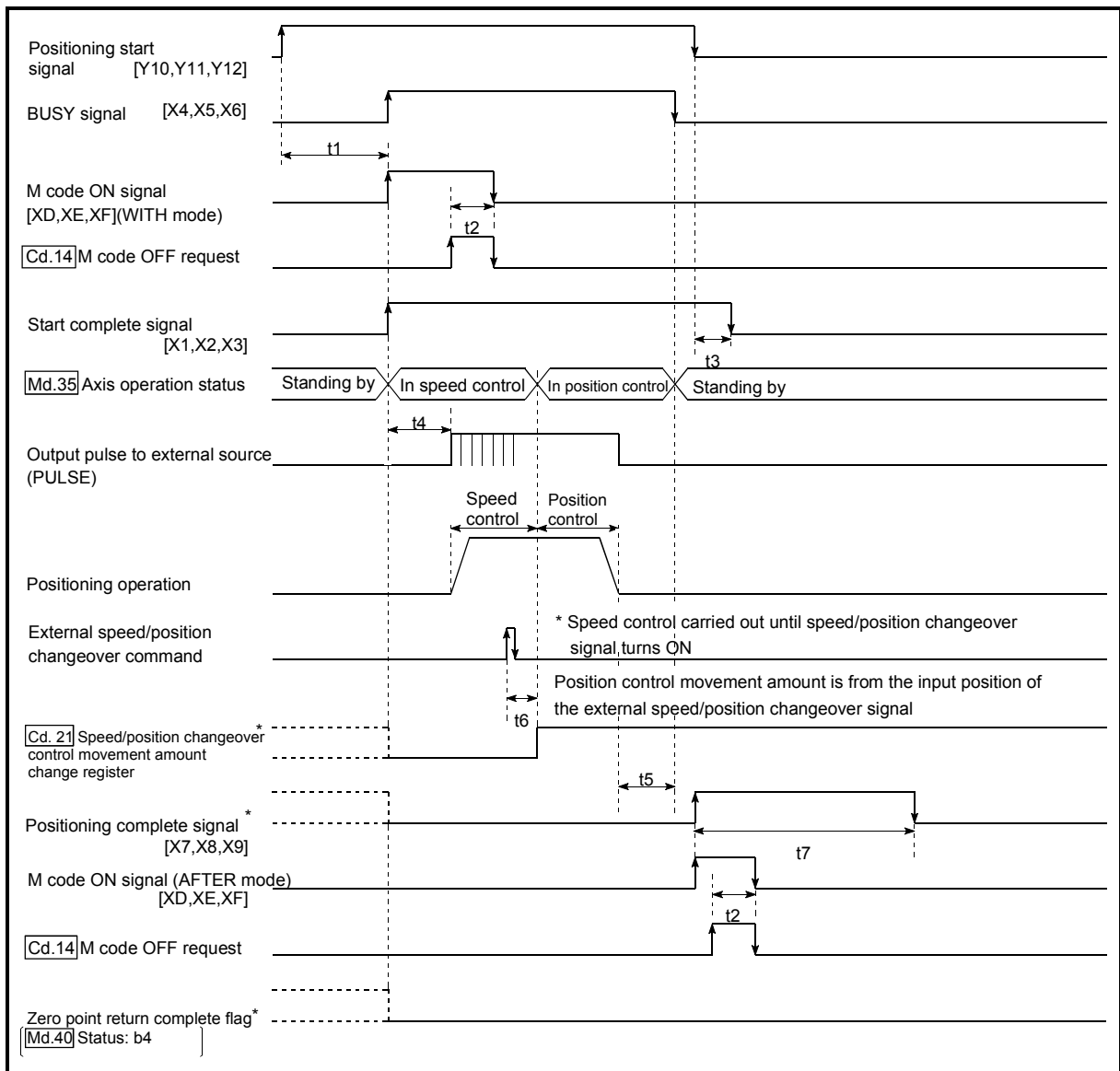

Fig. 9.11 Operation timing and processing time during speed/position changeover control

Normal timing time

Unit: ms

t1	t2	t3	t4	t5	t6	t7
5 to 15	0 to 60	0 to 3.5			1	Follows parameters

- The t1 timing time could be delayed by the following factors.
 - 1) Presence of FROM/TO command execution during start process
 - 2) Operation state of other axes
 - 3) Presence of intervention from peripheral device during start process
 - 4) Details of positioning data to be started

■ Current feed value during speed/position changeover control

The following table shows the "[Md.29] Current feed value" during speed/position changeover control corresponding to the "[Pr.22] Current feed value during speed control" settings.

"[Pr.22] Current feed value during speed control" setting	[Md.29] Current feed value
0: Do not update current feed value	The current feed value at control start is maintained during speed control, and updated from the changeover to position control.
1: Update current feed value	The current feed value is updated during speed control and position control.
2: Zero clear current feed value	The current feed value is cleared (set to "0") at control start, and updated from the changeover to position control.

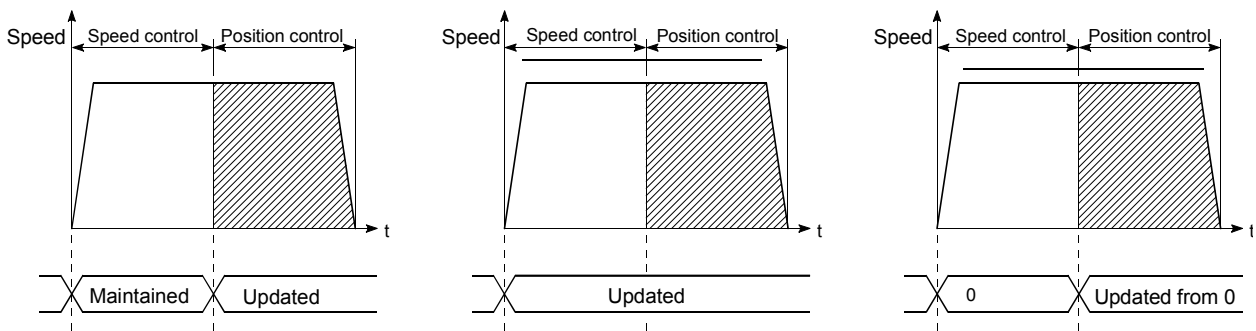

(a) Current feed value not updated

(b) Current feed value updated

(c) Current feed value zero cleared

■ Changeover time from speed control to position control

There is 1ms from the time the speed/position changeover signal is turned ON to the time the speed/position changeover latch flag ([Md.40] Status: b1) turns ON.

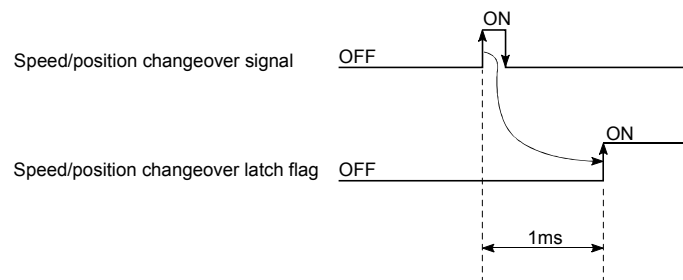

■ Changing the position control movement amount

In "speed/position changeover control", the position control movement amount can be changed during the speed control section.

- (1) The position control movement amount can be changed during the speed control section of speed/position changeover control.
A movement amount change request will be ignored unless issued during the speed control section of the speed/position changeover control.
- (2) The "new movement amount" is stored in "[Cd.21] Speed/position changeover control movement amount change register" by the sequence program during speed control.
This value then becomes the position control movement amount when the speed/position changeover signal turns ON.
- (3) The movement amount is stored in the "[Md.38] Speed/position changeover control positioning amount" of the axis monitor area from the point where the control changes to position control by the input of a speed/position changeover signal from an external source.

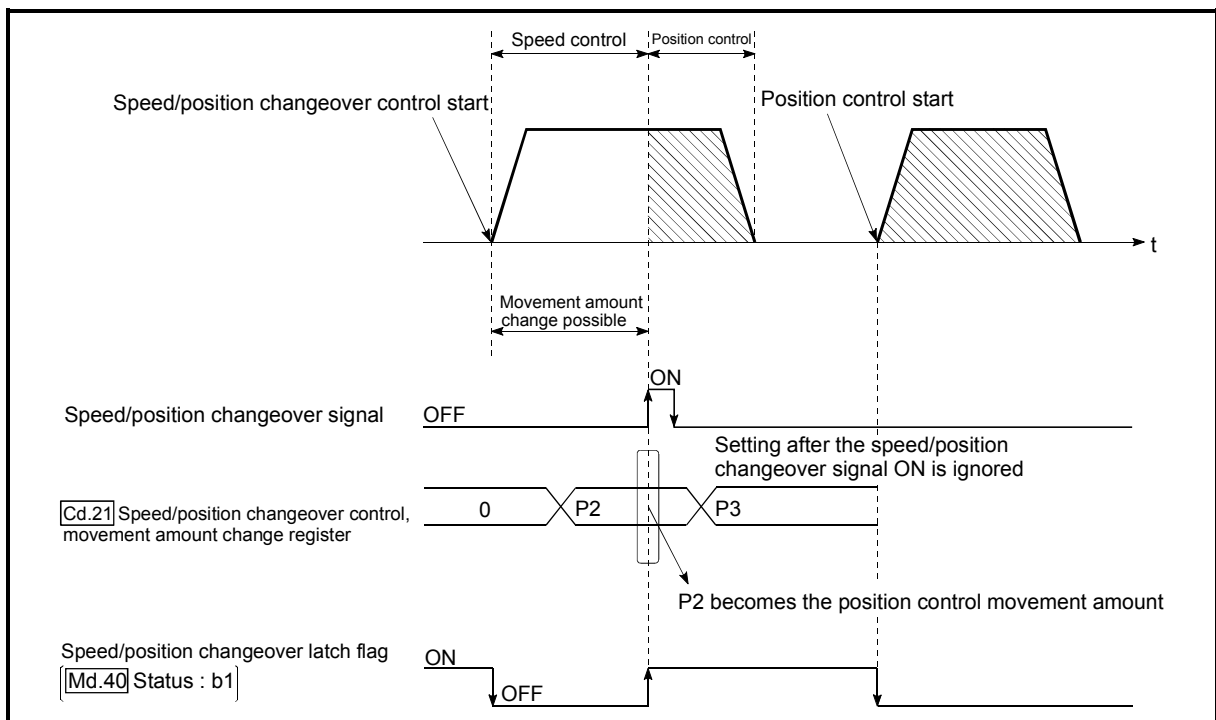

Fig. 9.12 Position control movement amount change timing

POINT
<ul style="list-style-type: none"> • The machine recognizes the presence of a movement amount change request when the data is written to "[Cd.21] Speed/position changeover control movement amount change register" with the sequence program. • The new movement amount is validated after execution of the speed/position changeover control, before the input of the speed/position changeover signal. • The movement amount change can be enabled/disabled with the interlock function in position control using the "speed/position changeover latch flag" of the axis monitor area.

■ Restrictions

- (1) If “continuous path control” is specified for “[Da.1] Operation pattern,” an error “continuous path control not possible” (error code: 516) occurs, resulting in a failure to start. (In the speed or position changeover control mode, “continuous path control” cannot be set.)
- (2) If “continuous path control” is specified for “[Da.1] Operation pattern” of the positioning data immediately before, “speed/position changeover control” cannot be specified for “[Da.2] Control method” in the positioning data. (For example, if the operation pattern of positioning data No. 1 is “continuous path control,” “speed/position changeover control” cannot be specified for positioning data No. 2.) If this setting is given, an error “continuous path control not possible” (error code: 516) occurs, resulting in deceleration and stop.
- (3) If the position control movement amount specified for “[Da.5] Positioning address/movement amount” is smaller than the deceleration distance from “[Da.7] Command speed,” deceleration occurs when the speed/position changeover signal is supplied.
- (4) Turn on the speed/position changeover signal in a stable-speed area (constant-speed state). If it is turned on during acceleration, a warning “speed/position changeover signal ON during acceleration” (warning code: 508) occurs due to large variation in the accumulating pulses.
- (5) The software stroke limit range check under speed control is performed only if “1: update current feed value” is specified for “[Pr.22] Current feed value during speed control.” At this time, if the movement amount exceeds the software stroke limit range during speed control, an error “start outside stroke limit +/-” (error code: 507/508) occurs at the timing of the change to position control, resulting in deceleration and stop.
If the “degree” unit is selected, the software stroke limit range check is not performed.
- (6) Do not turn ON the speed/position changeover signal during speed change if the servomotor is used. (Turn the speed/position changeover signal ON in the stable-speed area (constant-speed state).) The actual movement amount after switching is the “set movement amount + amount of accumulated pulses.” If the signal is turned on during acceleration or deceleration, there is variation in the stopping position due to a large variation in the amount of accumulated pulses. If “[Da.7] Command speed” varies even if “[Md.38] Speed/position changeover control positioning amount” is the same, the amount of accumulated pulses varies and therefore the stopping position varies.

■ Positioning data setting examples

The following table shows setting examples when "speed/position changeover control (forward run: speed/position)" is set in positioning data No. 1 of axis 1.

Setting item		Setting example	Setting details
Positioning data No. 1	Da.1	Operation pattern	Positioning complete Set "Positioning complete" assuming the next positioning data will not be executed. ("Continuous path control" cannot be set in "speed/position changeover control".)
	Da.2	Control method	Forward run: speed/position Set speed/position changeover control.
	Da.3	Acceleration time No.	1 Designate the value set in "[Pr.26] Acceleration time 1" as the acceleration time at start.
	Da.4	Deceleration time No.	0 Designate the value set in "[Pr.9] Deceleration time 0" as the deceleration time at deceleration.
	Da.5	Positioning address/movement amount	10000.0μm Set the movement amount after the changeover to position control. (Assuming that the "[Pr.1] Unit setting" is set to "mm".)
	Da.6	Arc address	- Setting not required. (Setting value is ignored.)
	Da.7	Command speed	6000.00mm/min Set the speed to be controlled.
	Da.8	Dwell time	500ms Set a time from the positioning stop (pulse output stop) by position control until the positioning complete signal is output. (When the system is stopped by speed control, ignore the setting value.)
	Da.9	M code	10 Set this when other auxiliary operation commands are issued in combination with the No. 1 positioning data.

* Refer to section "5.3 List of positioning data" for information on the setting details.

9.2.10 Current value change

When the current value is changed to a new value, control is carried out in which the "[Md.29] Current feed value" of the stopped axis is changed to a random address set by the user. (The "[Md.30] Machine feed value" is not changed when the current value is changed.)

The two methods for changing the current value are shown below.

- (1) Current value change using the positioning data
- (2) Current value change using the start No. (No. 9003) for a current value change

The current value change using method [1] is used during continuous positioning of multiple blocks, etc.

(1) Current value change using the positioning data

■ Operation chart

The following chart shows the operation timing for a current value change. The "[Md.29] Current feed value" is changed to the value set in "[Da.5] Positioning address/movement amount" when the positioning start signal turns ON.

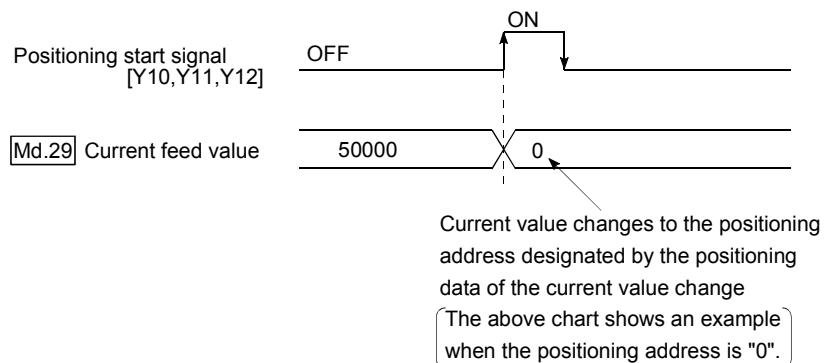

■ Restrictions

- (1) An error "Current value change not possible" (error code: 515) will occur and the operation cannot start if "continuous path control" is set in "[Da.1] Operation pattern". ("Continuous path control" cannot be set in current value change.)
- (2) "Current value change" cannot be set in "[Da.2] Control method" of the positioning data when "continuous path control" has been set in "[Da.1] Operation pattern" of the immediately prior positioning data. (For example, if the operation pattern of positioning data No. 1 is "continuous path control", "Current value change" cannot be set in positioning data No. 2.) An error "Current value change not possible" (error code: 515) will occur and the machine will carry out a deceleration stop if this type of setting is carried out.
- (3) An error "Outside current value change range" (error code: 514) will occur and the operation cannot start if "degree" is set in "[Pr.1] Unit setting" and the value set in "[Da.5] Positioning address/movement amount" is outside the setting range (0 to 359.99999 [degree]).
- (4) If the value set in "[Da.5] positioning address/movement amount" is outside the scope of software stroke limit ([Pr.13], [Pr.14]), the actual value will be modified. However, the error "Starting outside of stroke limit +/-" (error code: 507/508) and it will not start up.

■ Positioning data setting examples

The following table shows setting examples when "Current value change" is set in positioning data No. 1 of axis 1.

Setting item		Setting example	Setting details	
Positioning data No. 1	Da.1	Operation pattern	Positioning complete	Set "Positioning complete" assuming the next positioning data will not be executed. ("Continuous path control" cannot be set in current value change.)
	Da.2	Control method	Current value change	Set the current value change.
	Da.3	Acceleration time No.	1	Designate the value set in "[Pr.26] Acceleration time 1" as the acceleration time at start.
	Da.4	Deceleration time No.	0	Designate the value set in "[Pr.9] Deceleration time 0" as the deceleration time at deceleration.
	Da.5	Positioning address/movement amount	10000.0μm	Set the movement amount after the changeover to position control. (Assuming that the "[Pr.1] Unit setting" is set to "mm".)
	Da.6	Arc address	–	Setting not required. (Setting value is ignored.)
	Da.7	Command speed	6000.00mm/min	Set the speed to be controlled.
	Da.8	Dwell time	–	Setting not required. (Setting value is ignored.)
	Da.9	M code	10	Set this when other auxiliary operation commands are issued in combination with the No. 1 positioning data.

* Refer to section "5.3 List of positioning data" for information on the setting details.

(2) Current value change using the start No. (No. 9003) for a current value change

■ Operation chart

The current value is changed by setting the new current value in the new current value buffer memory "Cd.15 New current value", setting "9003" in the "Cd.11 Positioning start No.", and turning ON the positioning start signal.

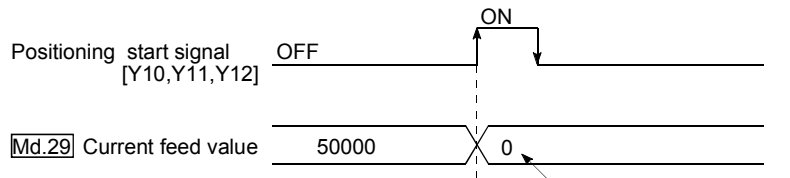

Current value changes to the positioning address designated by the new current value buffer memory.
 (The above chart shows an example when the positioning address is "0".)

■ Restrictions

- (1) An error "Outside current value change range" (error code: 514) will occur if the designated value is outside the setting range when "degree" is set in "Pr.1 Unit setting".
- (2) An error will not occur even if the designated value is outside the software stroke limit range.
 However, an error "Start outside stroke limit +/-" (error code: 507/508) will occur at the positioning start.
- (3) The current value cannot be changed during stop commands and while the M code ON signal is ON.

■ Current value change procedure

The following shows the procedure for changing the current value to a new value.

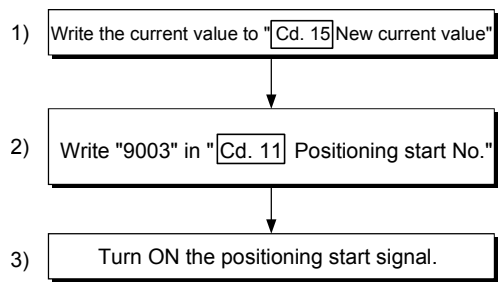

■ Setting method for the current value change function

The following shows an example of a sequence program and data setting to change the current value to a new value with the positioning start signal. (The "Md.29" Current feed value is changed to "5000.0μm" in the example shown.)

- (1) Set the following data.
(Set with the sequence program shown in (3), while referring to the start time chart shown in (2).)

Setting item	Setting value	Setting details	Buffer memory address			
			Axis 1	Axis 2	Axis 3	
Cd.15	New current value	50000	Set the new "Md.29" Current feed value".	1154 1155	1204 1205	1254 1255
Cd.11	Positioning start No.	9003	Set the start No. "9003" for the current value change.	1150	1200	1250

* Refer to section "5.7 List of control data" for details on the setting details.

- (2) The following shows a start time chart.

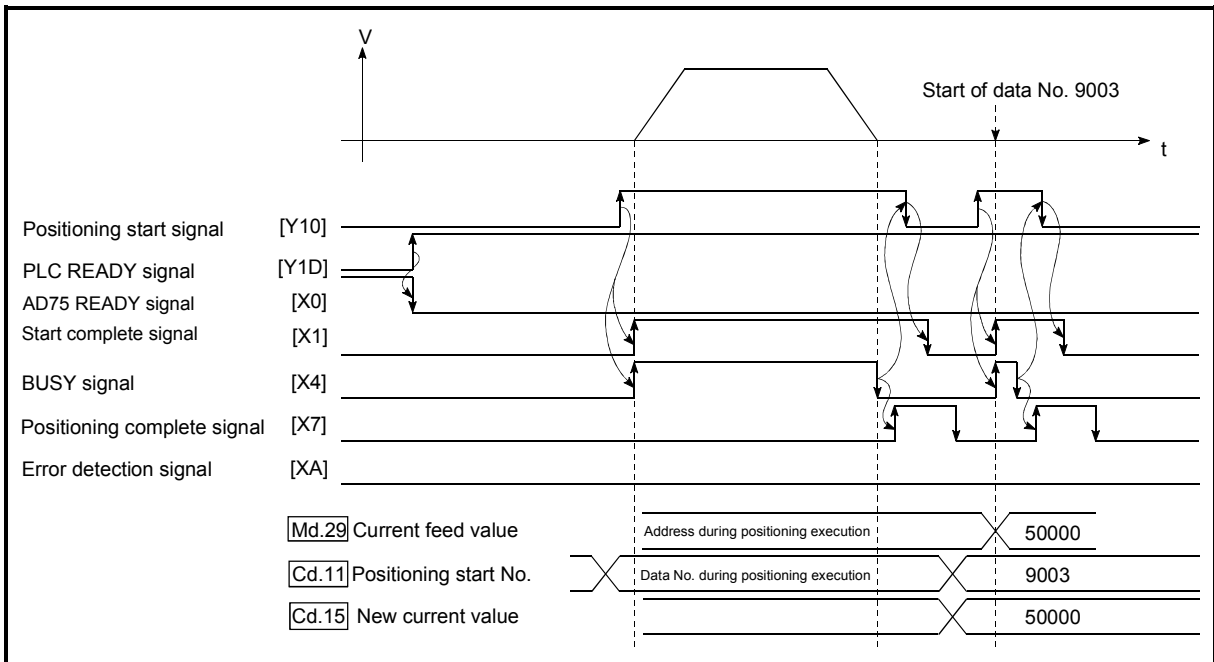
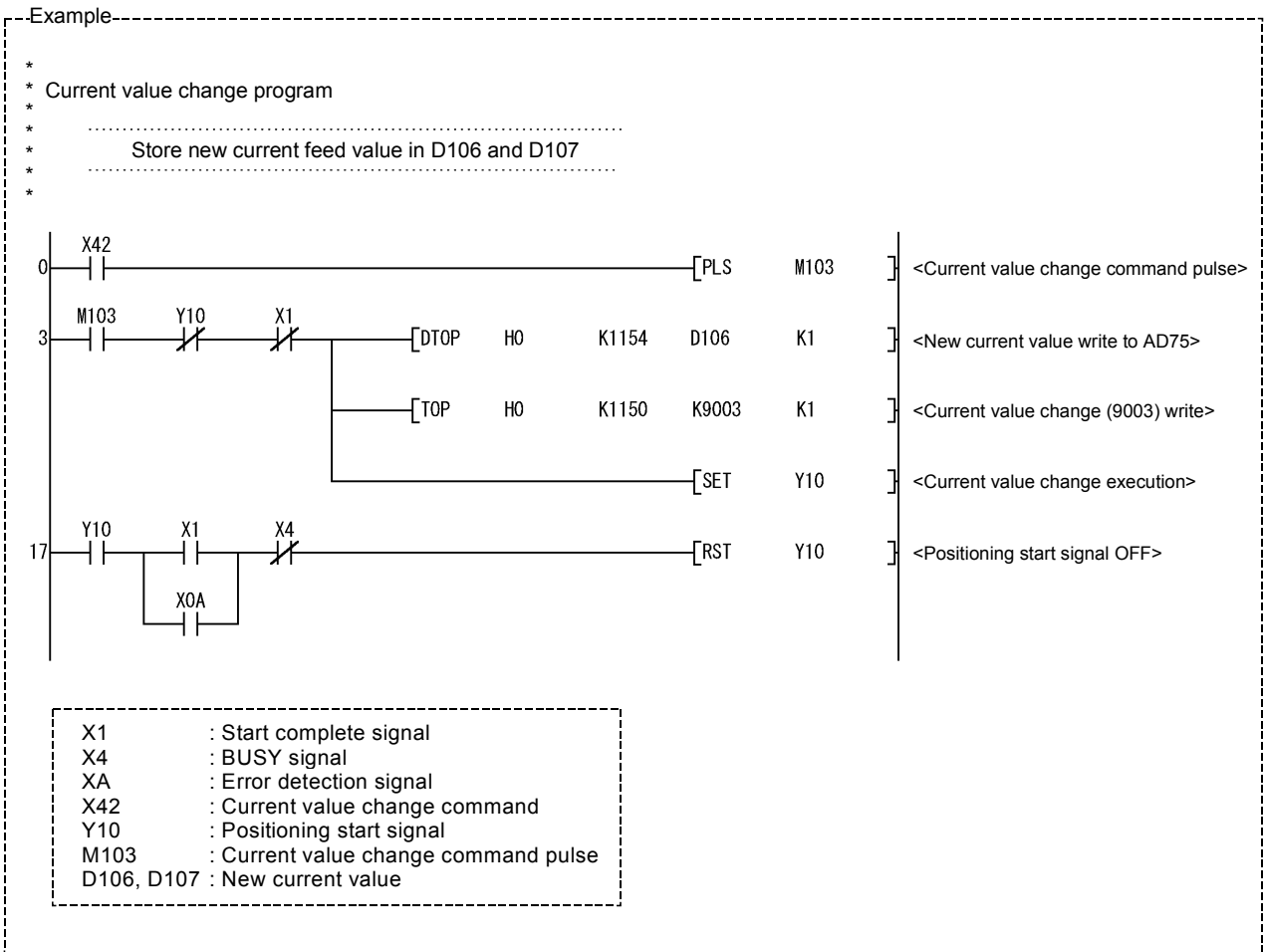

Fig. 9.13 Current value change using the start No. (No. 9003) for a current value change

(3) Add the following sequence program to the control program, and write it to the PLC CPU.



9.2.11 JUMP command

The JUMP command is used to control the operation so it jumps to a positioning data No. set in the positioning data during "continuous positioning control" or "continuous path control".

JUMP commands include the following two types of JUMP.

- (1) Unconditional JUMP
When no execution conditions are set for the JUMP command
- (2) Conditional JUMP
When execution conditions are set for the JUMP command
(The conditions are set in the "condition data" used with "advanced positioning control".)

Using the JUMP command enables repeating of the same positioning control, or selection of positioning data by the execution conditions during "continuous positioning control" or "continuous path control".

■ Operation

- (1) Unconditional JUMP
The JUMP command is unconditionally executed. The operation jumps to the positioning data No. set in "[Da.8] Dwell time".
- (2) Conditional JUMP
 - If the JUMP command execution conditions set in "[Da.9] M code" have been established, the JUMP command is executed and the operation jumps to the positioning data No. set in "[Da.8] Dwell time".
 - If the JUMP command execution conditions set in "[Da.9] M code" have not been established, the JUMP command is ignored and the next positioning data No. is executed.

■ Restrictions

- (1) When using a conditional JUMP command, establish the JUMP command execution conditions by the 4th positioning data No. before the JUMP command positioning data No.
If the JUMP command execution conditions are not established by the time the 4th positioning control is carried out before the JUMP command positioning data No., the operation will be processed as an operation without established JUMP command execution conditions.
(During execution of continuous path control/continuous positioning control, the AD75 calculates the positioning data of the positioning data No. four items ahead of the current positioning data.)
- (2) Set JUMP commands in positioning data No. of "continuous positioning control" or "continuous path" operation patterns.
JUMP commands cannot be set in the positioning data No. of a "Positioning complete" operation pattern.

(3) Positioning control such as loops cannot be executed by conditional JUMP commands alone until the conditions have been established.

■ Positioning data setting example

The following table shows setting examples when "JUMP command" is set in positioning data No. 1 of axis 1.

Setting item		Setting example	Setting details
Positioning data No. 1	Da.1	Operation pattern	Continuous path control Set "continuous positioning control" or "continuous path control". ("Positioning complete" cannot be set with JUMP commands.)
	Da.2	Control method	JUMP command Set the JUMP command.
	Da.3	Acceleration time No.	– Setting not required. (Setting value is ignored.)
	Da.4	Deceleration time No.	– Setting not required. (Setting value is ignored.)
	Da.5	Positioning address/movement amount	– Setting not required. (Setting value is ignored.)
	Da.6	Arc address	– Setting not required. (Setting value is ignored.)
	Da.7	Command speed	– Setting not required. (Setting value is ignored.)
	Da.8	Dwell time	500 Set the positioning data No. 1 to 600 for the JUMP destination. (The positioning data No. of the JUMP command cannot be set.)
	Da.9	M code	10 Set the JUMP command execution conditions with the condition data No. 0 : Unconditional JUMP 1 to 10 : Condition data No. ("Simultaneous start" condition data cannot be set.)

* Refer to section "5.3 List of positioning data" for information on the setting details.

Chapter 10

ADVANCED POSITIONING CONTROL

The details and usage of advanced positioning control (control functions using the "start block data") are explained in this chapter.

Advanced positioning control is used to carry out applied control using the "positioning data". Examples of advanced control are using conditional judgment to control "positioning data" set with the main positioning control, or simultaneously starting "positioning data" for several different axes.

Read the execution procedures and settings for each control, and set as required.

10.1	Outline of advanced positioning control	10- 2
10.1.1	Data required for advanced positioning control	10- 3
10.1.2	"Start block data" and "condition data" configuration.....	10- 4
10.2	Advanced positioning control execution procedure	10- 6
10.3	Setting the start block data	10- 7
10.3.1	Relation between various controls and start block data	10- 7
10.3.2	Block start (normal start)	10- 8
10.3.3	Condition start	10- 10
10.3.4	Wait start	10- 11
10.3.5	Simultaneous start	10- 12
10.3.6	Stop	10- 13
10.3.7	Repeated start (FOR loop)	10- 14
10.3.8	Repeated start (FOR condition)	10- 15
10.3.9	Restrictions when using the NEXT start.....	10- 16
10.4	Setting the condition data	10- 17
10.4.1	Relation between various controls and the condition data	10- 17
10.4.2	Condition data setting examples	10- 19
10.5	Start program for advanced positioning control.....	10- 20
10.5.1	Starting advanced positioning control	10- 20
10.5.2	Example of a start program for advanced positioning control	10- 21

10.1 Outline of advanced positioning control

In "advanced positioning control" the execution order and execution conditions of the "positioning data" are set to carry out more applied positioning. (The execution order and execution conditions are set in the "start block data" and "condition data".)
The following applied positioning controls can be carried out with "advanced positioning control".

Advanced positioning control	Details
Block* start (Normal start)	With one start, executes the positioning data in a random block with the set order.
Condition start	Carries out condition judgment set in the "condition data" for the designated positioning data, and then executes the "start block data". When the condition is established, the "start block data" is executed. When not established, that "start block data" is ignored, and the next point's "start block data" is executed.
Wait start	Carries out condition judgment set in the "condition data" for the designated positioning data, and then executes the "start block data". When the condition is established, the "start block data" is executed. When not established, stops the control until the condition is established. (Waits.)
Simultaneous start	Simultaneously executes the positioning data having the No. for the axis designated with the "condition data". (Outputs pulses at the same timing.)
Stop	Stops the positioning operation.
Repeated start (FOR loop)	Repeats the program from the "start block data" set with the "FOR loop" to the "start block data" set in "NEXT" for the designated No. of times.
Repeated start (FOR condition)	Repeats the program from the "start block data" set with the "FOR condition" to the "start block data" set in "NEXT" until the conditions set in the "condition data" are established.

■ Advanced positioning control auxiliary functions

"Advanced positioning control" uses the "positioning data" set with the "main positioning control". Refer to "3.3.4 Combination of AD75 main functions and auxiliary functions" for details on auxiliary functions that can be combined with the main positioning control.

■ Advanced positioning control from peripheral devices

"Advanced positioning control" (start of the "start block data") can be executed from the AD75 software package test mode.
Refer to the AD75 Software Package Operating Manual for details on starting of the "start block data" from the AD75 software package.

REMARK

Block *:

"1 block" is defined as all the data continuing from the positioning data in which "continuous positioning control" or "continuous path control" is set in the operation pattern (Da.1) to the positioning data in which "independent positioning control (Positioning complete)" is set.

10.1.1 Data required for advanced positioning control

"Advanced positioning control" is executed by setting the required items in the "start block data" and "condition data", then starting that "start block data". Judgment about whether execution is possible, etc., is carried out at execution using the "condition data" designated in the "start block data".

"Start block data" can be set for each No. from 7000 to 7010 (called "block Nos."), and up to 50 points can be set for each axis. (This data is controlled with Nos. called "points" to distinguish it from the positioning data. For example, the 1st start block data item is called the "1st point start block data" or "point No. 1 start block data".)

"Condition data" can be set for each No. from 7000 to 7010 (called "block Nos."), and up to 10 data items can be set for each axis.

The "start block data" and "condition data" are set as 1 set for each block No.

The following table shows an outline of the "start block data" and "condition data" stored in the AD75.

Setting item		Setting details
Start block data	Da.10	Shape
	Da.11	Start data No.
	Da.12	Special start command
	Da.13	Parameter

Setting item		Setting details
Condition data	Da.14	Condition target
	Da.15	Condition operator
	Da.16	Address
	Da.17	Parameter 1
	Da.18	Parameter 2

10.1.2 "Start block data" and "condition data" configuration

The "start block data" and "condition data" corresponding to "block No. 7000" can be stored in the buffer memory. (The following drawing shows an example for axis 1.)

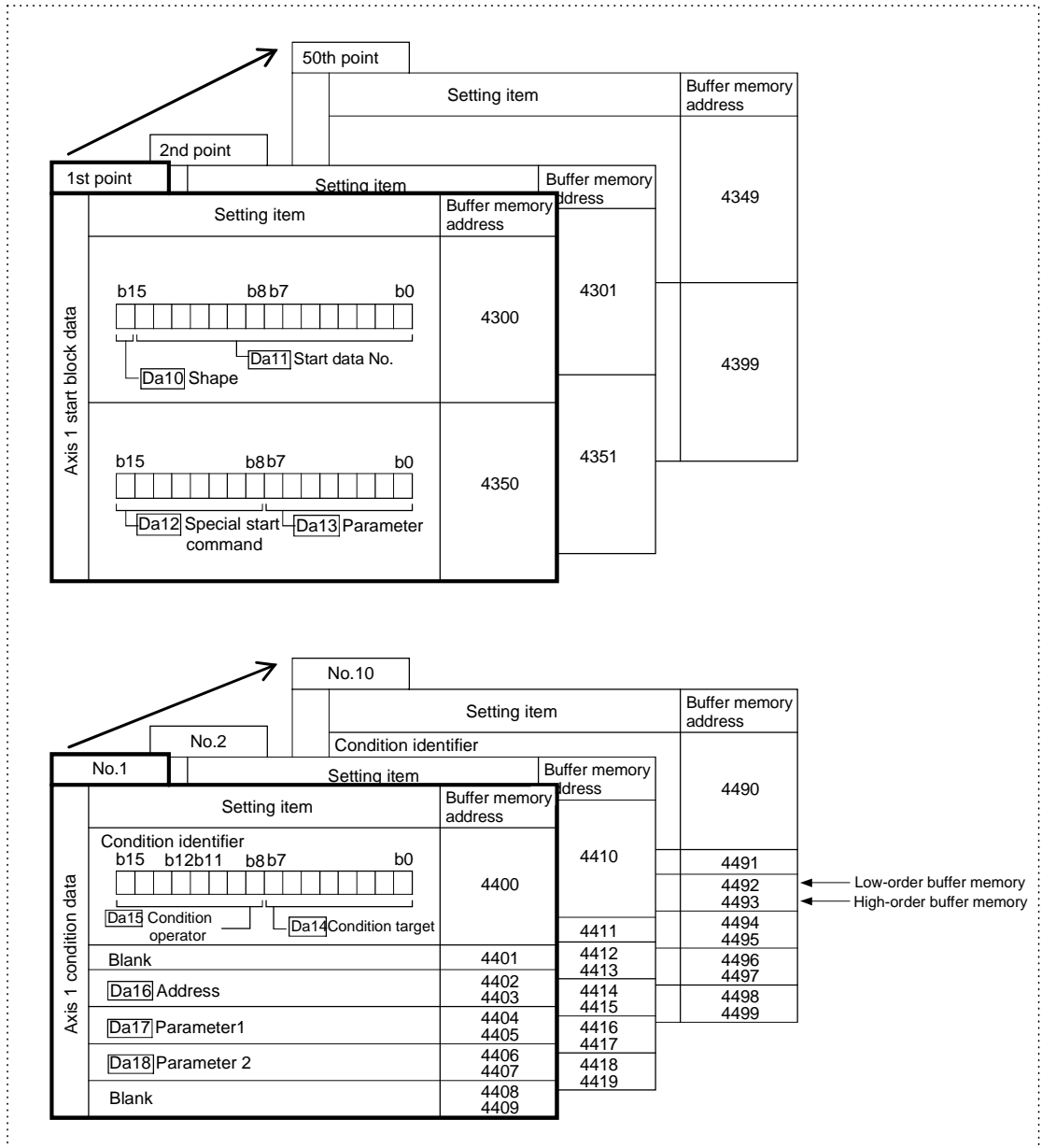

(Same for axis 2 and axis 3.)

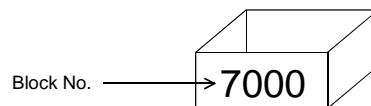

* Set in the AD75 with a sequence program or the AD75 software package.

Set in AD75 the "start block data" and "condition data" corresponding to the following "block Nos. 7001 to 7010" using the AD75 software package. (The following drawing shows an example for axis 1.)

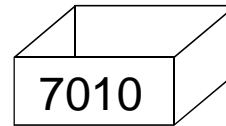
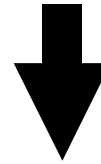
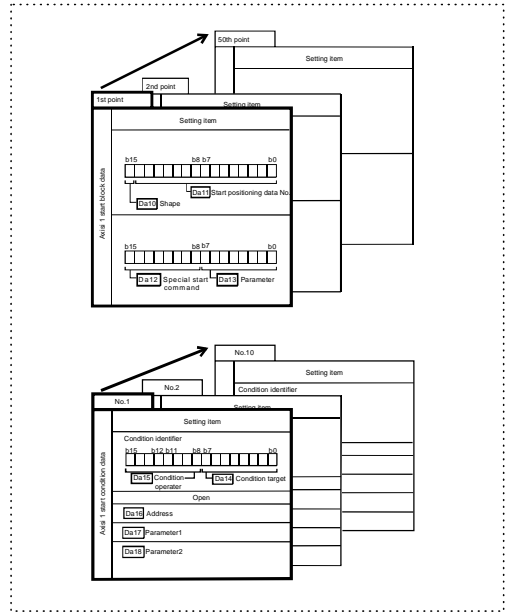
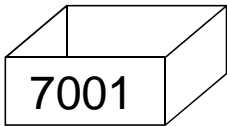
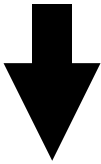
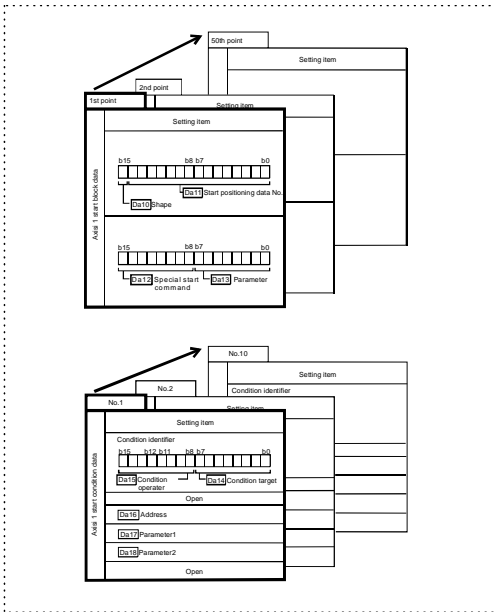

* Setting is only possible when the AD75 software package is used.
(Same for axis 2 and axis 3.)

10.2 Advanced positioning control execution procedure

Advanced positioning control is carried out using the following procedure.

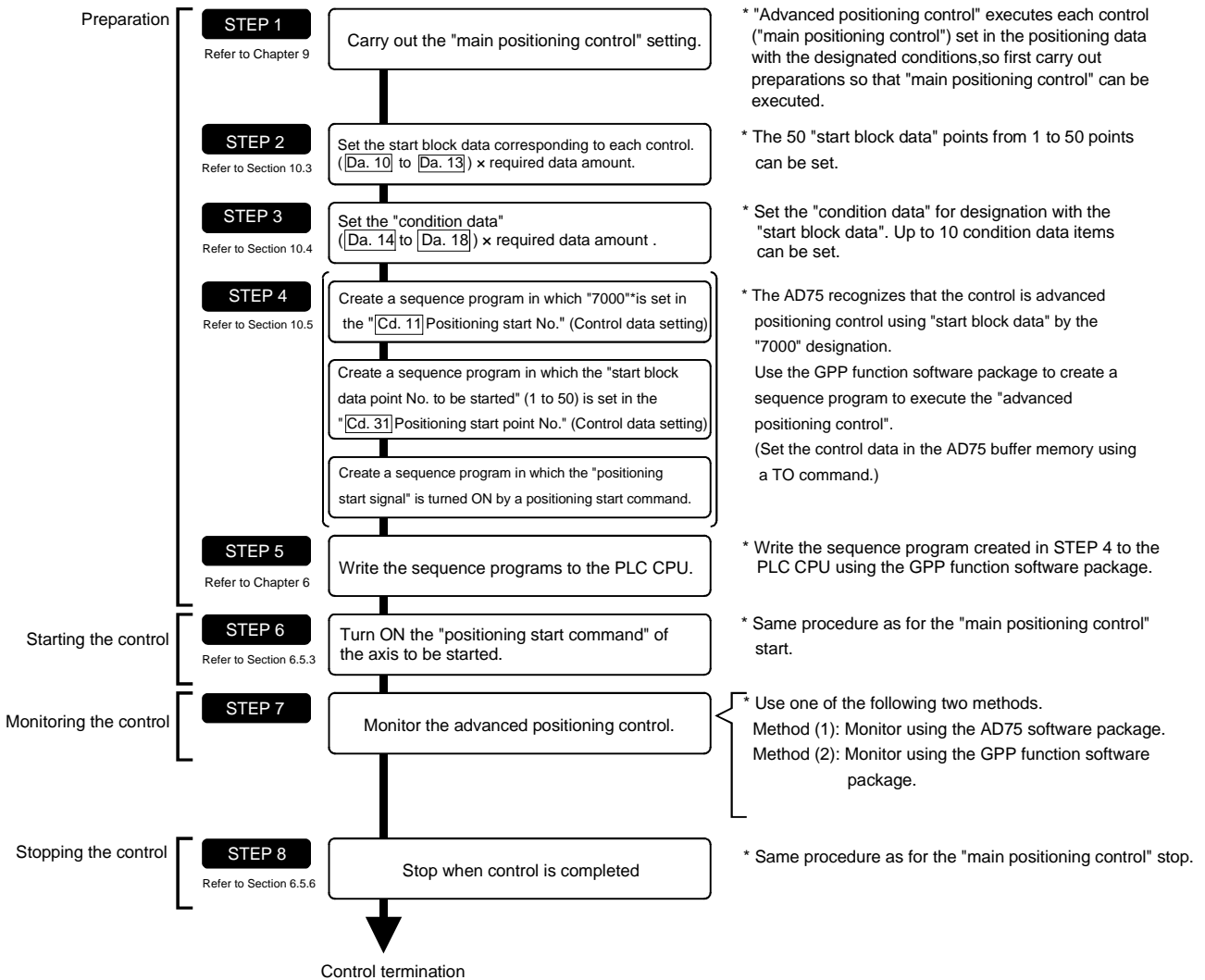

REMARK

- * (1) One set of "start block data (50 points)" and "condition data (10 items)" corresponding to "7000" is set with a sequence program.
- (2) Eleven sets of data from "7000" to "7010" can be set when the AD75 software package is used. If the AD75 software package is used to set the "start block data" and "condition data" corresponding to "7001" to "7010" and write the data to the AD75, "7001" to "7010" can be set in "[Cd.11] Positioning start No." in STEP 4.

10.3 Setting the start block data

10.3.1 Relation between various controls and start block data

The "start block data" must be set to carry out "advanced positioning control". The setting requirements and details of each "start block data" item to be set differ according to the "[Da.12] Special start command" setting.

The following shows the "start block data" setting items corresponding to various control methods. The operation details of each control type are explained starting in section 10.3.2. Also refer to section "10.4 Setting the condition data" for details on "condition data" with which control execution is judged.

(The "start block data" settings in this chapter are assumed to be carried out using the AD75 software package.)

Start block data setting items		Advanced positioning control	Block start (Normal start)	Condition start	Wait start	Simultaneous start	Stop	Repeated start (FOR loop)	Repeated start (FOR condition)	NEXT start *
[Da.10]	Shape	0 : End	◎	◎	◎	◎	◎	×	×	◎
		1 : Continue	◎	◎	◎	◎	◎	◎	◎	◎
[Da.11]	Start data No.	1 to 600								
[Da.12]	Special start command	0	1	2	3	4	5	6	7	
[Da.13]	Parameter	—	Condition data No.			—	No. of repetitions	Condition data No.	—	

- ◎ : One of the two setting items must be set.
- : Set when required (Set to " — " when not used.)
- × : Setting not possible
- : Setting not required (Setting value will be ignored. Use the initial value or a value within the setting range.)

* The "NEXT start" command is used in combination with "repeated start (FOR loop)" and "repeated start (FOR condition)". Control using only the "NEXT start" will not be carried out.

REMARK

It is recommended that the "start block data" be set whenever possible with the AD75 software package. Execution by sequence program uses many sequence programs and devices. The execution becomes complicated, and the scan times will increase.

10.3.2 Block start (normal start)

In a "block start (normal start)", the positioning data groups of a block are continuously executed in a set sequence starting from the positioning data set in "[Da.11] Start data No." by one start.

Section [2] shows a control example where the "start block data" and "positioning data" are set as shown in section [1].

(1) Setting examples

(a) Start block data setting example

Axis 1 start block data	[Da.10] Shape	[Da.11] Start data No.	[Da.12] Special start command	[Da.13] Parameter
1st point	1: Continue	1	0: Normal start	—
2nd point	1: Continue	2	0: Normal start	—
3rd point	1: Continue	5	0: Normal start	—
4th point	1: Continue	10	0: Normal start	—
5th point	0: End	15	0: Normal start	—
•				
•				

(b) Positioning data setting example

Axis 1 positioning data No.	[Da.1] Operation pattern	
1	00: Positioning complete	} 1 block *
2	11: Continuous path control	
3	01: Continuous positioning control	
4	00: Positioning complete	
5	11: Continuous path control	} 1 block
6	00: Positioning complete	
•		
10	00: Positioning complete	
•		
15	00: Positioning complete	
•		

REMARK

Block * :

"1 block" is defined as all the data continuing from the positioning data in which "continuous positioning control" or "continuous path control" is set in the operation pattern ([Da.1]) to the positioning data in which "independent positioning control (Positioning complete)" is set.

(2) Control examples

The following shows the control executed when the "start block data" of the 1st point of axis 1 is set as shown in section (1) and started.

<1> The positioning data is executed in the following order before stopping.
 Axis 1 positioning data No. 1 → 2 → 3 → 4 → 5 → 6 → 10 → 15.

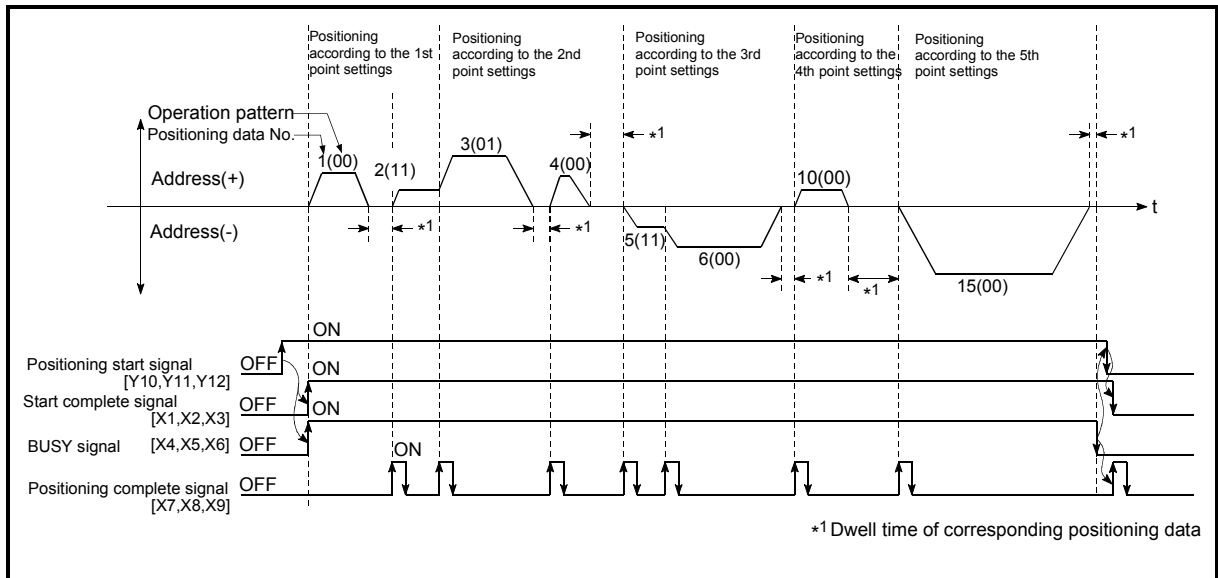

Fig. 10.1 Block start control example

10.3.3 Condition start

In a "condition start", the "condition data" conditional judgment designated in "[Da.13] Parameter" is carried out for the positioning data set in "[Da.11] Start data No.". If the conditions have been established, the "start block data" set in "1: condition start" is executed. If the conditions have not been established, that "start block data" will be ignored, and the "start block data" of the next point will be executed.

Section (2) shows a control example where the "start block data" and "positioning data" are set as shown in section (1).

(1) Setting examples

(a) Start block data setting example

Axis 1 start block data	[Da.10] Shape	[Da.11] Start data No.	[Da.12] Special start command	[Da.13] Parameter
1st point	1: Continue	1	1: Condition start	1
2nd point	1: Continue	10	1: Condition start	2
3rd point	0: End	50	0: Normal start	-
•				
•				

* The "condition data Nos." have been set in "[Da.13] Parameter".

(b) Positioning data setting example

Axis 1 positioning data No.	[Da.1] Operation pattern
1	01: Continuous positioning control
2	01: Continuous positioning control
3	00: Positioning complete
•	
10	11: Continuous path control
11	11: Continuous path control
12	00: Positioning complete
•	
50	00: Positioning complete
•	

(2) Control examples

The following shows the control executed when the "start block data" of the 1st point of axis 1 is set as shown in section (1) and started.

- <1> The conditional judgment set in "condition data No. 1" is carried out before execution of the axis 1 "positioning data No. 1".
 - Conditions established → Execute positioning data No. 1, 2, and 3 → Go to <2>.
 - Conditions not established → Go to <2>.
- <2> The conditional judgment set in "condition data No. 2" is carried out before execution of the axis 1 "positioning data No. 10".
 - Conditions established → Execute positioning data No. 10, 11, and 12 → Go to <3>.
 - Conditions not established → Go to <3>.
- <3> Execute axis 1 "positioning data No. 50" and stop the control.

10.3.4 Wait start

In a "wait start", the "condition data" conditional judgment designated in "[Da.13] Parameter" is carried out for the positioning data set in "[Da.11] Start data No.". If the conditions have been established, the "start block data" is executed. If the conditions have not been established, the control stops (waits) until the conditions are established.

Section (2) shows a control example where the "start block data" and "positioning data" are set as shown in section (1).

(1) Setting examples

(a) Start block data setting example

Axis 1 start block data	[Da.10] Shape	[Da.11] Start data No.	[Da.12] Special start command	[Da.13] Parameter
1st point	1: Continue	1	2: Wait start	3
2nd point	1: Continue	10	0: Normal start	–
3rd point	0: End	50	0: Normal start	–
•				
•				

* The "condition data Nos." have been set in "[Da.13] Parameter".

(b) Positioning data setting example

Axis 1 positioning data No.	[Da.1] Operation pattern
1	01: Continuous positioning control
2	01: Continuous positioning control
3	00: Positioning complete
•	
10	11: Continuous path control
11	11: Continuous path control
12	00: Positioning complete
•	
50	00: Positioning complete
•	

(2) Control examples

The following shows the control executed when the "start block data" of the 1st point of axis 1 is set as shown in section (1) and started.

<1> The conditional judgment set in "condition data No. 3" is carried out before execution of the axis 1 "positioning data No. 1".

→ Conditions established → Execute positioning data No. 1, 2, and 3 → Go to <2>.

→ Conditions not established → Control stops (waits) until conditions are established → Go to <1>.

<2> Execute the axis 1 "positioning data No. 10, 11, 12, and 50" and stop the control.

10.3.5 Simultaneous start

In a "simultaneous start", the positioning data set in the "[Da.11] Start data No." and positioning data of other axes set in the "condition data" are simultaneously executed (Outputs pulses at the same timing).

(The "condition data" is designated with "[Da.13] Parameter".)

Section (2) shows a control example where the "start block data" and "positioning data" are set as shown in section (1).

(1) Setting examples

(a) Start block data setting example

Axis 1 start block data	[Da.10] Shape	[Da.11] Start data No.	[Da.12] Special start command	[Da.13] Parameter
1st point	1: Continue	1	3: Simultaneous start	4
2nd point	1: Continue	10	3: Simultaneous start	5
3rd point	0: End	50	3: Simultaneous start	6
•				
•				

* It is assumed that the "axis 2 positioning data" for simultaneous starting is set in the "condition data" designated with "[Da.13] Parameter".

(b) Positioning data setting example

Axis 1 positioning data No.	[Da.1] Operation pattern
1	01: Continuous positioning control
2	01: Continuous positioning control
3	00: Positioning complete
•	
10	11: Continuous path control
11	11: Continuous path control
12	00: Positioning complete
•	
50	00: Positioning complete
•	

(2) Control examples

The following shows the control executed when the "start block data" of the 1st point of axis 1 is set as shown in section (1) and started.

- <1> Simultaneously start the axis 1 "positioning data No. 1" and axis 2 positioning data set in "condition data No. 4". After the execution of axis 1 "positioning data No. 1, 2, and 3" is completed, go to <2>.
- <2> Simultaneously start the axis 1 "positioning data No. 10" and axis 2 positioning data set in "condition data No. 5".
 - Standing by after completion of axis 2 positioning data simultaneously started in <1>. → Go to <3>.
 - Executing other axis positioning data simultaneously started in <1>. → "Error".
- <3> Simultaneously start the axis 1 "positioning data No. 50" and the axis 2 positioning data set in "condition data No. 6" after the completion of the execution of axis 1 "positioning data No. 10, 11, and 12".
 - Standing by after completion of axis 2 positioning data simultaneously started in <2>. → Go to <4>.
 - Executing axis 2 positioning data simultaneously started in <2>. → "Error".
- <4> After the execution of the axis 1 "positioning data No. 50" is completed, stop the control.

10.3.6 Stop

In a "stop", the control is stopped with the "start block data" set in "4: stop".
 The control after the point in which the "stop" is set can be restarted by issuing a "[Cd.13] Restart command".

Section (2) shows a control example where the "start block data" and "positioning data" are set as shown in section (1).

(1) Setting examples

(a) Start block data setting example

Axis 1 start block data	[Da.10] Shape	[Da.11] Start data No.	[Da.12] Special start command	[Da.13] Parameter
1st point	1: Continue	1	0: Normal start	-
2nd point	1: Continue	10	4: Stop	-
3rd point	0: End	50	0: Normal start	-
•				
•				

(b) Positioning data setting example

Axis 1 positioning data No.	[Da.1] Operation pattern
1	01: Continuous positioning control
2	01: Continuous positioning control
3	00: Positioning complete
•	
10	11: Continuous path control
11	11: Continuous path control
12	00: Positioning complete
•	
50	00: Positioning complete
•	

(2) Control examples

The following shows the control executed when the "start block data" of the 1st point of axis 1 is set as shown in section (1) and started.

- <1> Execute the axis 1 "positioning data No. 1, 2, and 3" and stop the control.
- <2> After executing a "restart", execute the axis 1 "positioning data No. 10, 11, 12, and 50", and stop the control.

10.3.7 Repeated start (FOR loop)

In a "repeated start (FOR loop)", the data between the "start block data" in which "5: FOR loop" is set in "[Da.12] Special start command" and the "start block data" in which "7: NEXT start" is set in "[Da.12] Special start command" is repeatedly executed for the No. of times set in "[Da.13] Parameter". An endless loop will result if the No. of repetitions is set to "0", and the data between "5: FOR loop" and "7: NEXT start" will be repeated until the control is stopped by a "stop command".
 (The No. of repetitions is set in "[Da.13] Parameter" of the "start block data" in which "5: FOR loop" is set in "[Da.12] Special start command".)

Section (2) shows a control example where the "start block data" and "positioning data" are set as shown in section (1).

(1) Setting examples

(a) Start block data setting example

Axis 1 start block data	[Da.10] Shape	[Da.11] Start data No.	[Da.12] Special start command	[Da.13] Parameter
1st point	1: Continue	1	5: FOR loop	2
2nd point	1: Continue	10	0: Normal start	-
3rd point	0: End	50	7: NEXT start	-
•				
•				

* The "condition data Nos." have been set in "[Da.13] Parameter".

(b) Positioning data setting example

Axis 1 positioning data No.	[Da.1] Operation pattern
1	01: Continuous positioning control
2	01: Continuous positioning control
3	00: Positioning complete
•	
10	11: Continuous path control
11	00: Positioning complete
•	
50	01: Continuous positioning control
51	00: Positioning complete
•	

(2) Control examples

The following shows the control executed when the "start block data" of the 1st point of axis 1 is set as shown in section (1) and started.

<1> Execute the axis 1 "positioning data No. 1, 2, 3, 10, 11, 50, and 51".

<2> Return to the axis 1 "1st point start block data". Again execute the axis 1 "positioning data No. 1, 2, 3, 10, 12, and 50", and then stop the control.
 (Repeat for the No. of times set in [Da.13].)

10.3.8 Repeated start (FOR condition)

In a "repeated start (FOR condition)", the data between the "start block data" in which "6: FOR condition" is set in "[Da.12] Special start command" and the "start block data" in which "7: NEXT start" is set in "[Da.12] Special start command" is repeatedly executed until the establishment of the conditions set in the "condition data". (The "condition data" designation is set in "[Da.13] Parameter" of the "start block data" in which "6: FOR condition" is set in "[Da.12] Special start command".)

Section (2) shows a control example where the "start block data" and "positioning data" are set as shown in section (1).

(1) Setting examples

(a) Start block data setting example

Axis 1 start block data	[Da.10] Shape	[Da.11] Start data No.	[Da.12] Special start command	[Da.13] Parameter
1st point	1: Continue	1	6: FOR condition	5
2nd point	1: Continue	10	0: Normal start	—
3rd point	0: End	50	7: NEXT start	—
•				
•				

* The "condition data Nos." have been set in "[Da.13] Parameter".

(b) Positioning data setting example

Axis 1 positioning data No.	[Da.1] Operation pattern
1	01: Continuous positioning control
2	01: Continuous positioning control
3	00: Positioning complete
•	
10	11: Continuous path control
11	00: Positioning complete
•	
50	01: Continuous positioning control
51	00: Positioning complete
•	

(2) Control examples

The following shows the control executed when the "start block data" of the 1st point of axis 1 is set as shown in section (1) and started.

- <1> Carry out the conditional judgment set in "condition data No. 5" for the axis 1 "positioning data No. 1".
 - Conditions not established → Go to <2>.
 - Conditions established → Go to <3>.
- <2> Execute axis 1 "positioning data No. 1, 2, 3, 10, 11, 50, and 51", then go to <1>.
- <3> Execute axis 1 "positioning data No. 1, 2, 3, 10, 11, 50, and 51", then stop the control.

10.3.9 Restrictions when using the NEXT start

The "NEXT start" is a command indicating the end of the repetitions when executing section "10.3.7 Repeated start (FOR loop)" and section "10.3.8 Repeated start (FOR condition)".

The following shows the restrictions when setting "7: NEXT start" in the "start block data".

- (1) The processing when "7: NEXT start" is set before execution of "5: FOR loop" or "6: FOR condition" is the same as that for a "0: normal start".
- (2) Repeated processing will not be carried out if there is no "7: NEXT start" command after the "5: FOR loop" or "6: FOR condition" command. (Note that an "error" will not occur.)
- (3) Nesting is not possible between "5: FOR loop" and "7: NEXT start", or between "6: FOR condition" and "7: NEXT start". A warning "FOR to NEXT nesting structure" (warning code: 506) will occur if nesting is attempted.

[Operating examples without nesting structure]

Start block data	Da.12 Special start command
1st point	Normal start
2nd point	FOR
3rd point	Normal start
4th point	NEXT
5th point	Normal start
6th point	Normal start
7th point	FOR
8th point	Normal start
9th point	NEXT
•	
•	

[Operating examples with nesting structure]

Start block data	Da.12 Special start command
1st point	Normal start
2nd point	FOR
3rd point	Normal start
4th point	FOR
5th point	Normal start
6th point	Normal start
7th point	NEXT
8th point	Normal start
9th point	NEXT
•	
•	

A warning will occur when starting the 4th point "FOR".
 The JUMP destination of the 7th point "NEXT" is the 4th point. The 9th point "NEXT" is processed as normal start.

10.4 Setting the condition data

10.4.1 Relation between various controls and the condition data

"Condition data" is set in the following cases.

- (1) When setting conditions during execution of section "9.2.11 JUMP command" (main positioning control)
- (2) When setting conditions during execution of "advanced positioning control"

The "condition data" to be set includes the 5 setting items from [Da.14] to [Da.18], but the setting requirements and details differ according to the control methods and setting conditions.

The following shows the "condition data" "[Da.14] Condition target" corresponding to the different types of control.

(The "condition data" settings in this chapter are assumed to be carried out using the AD75 software package.)

Control type [Da.14] setting item	Advanced positioning control				Main positioning control
	Block start	Wait start	Simultaneous start	Repeated start (For condition)	JUMP command
01H: Device X	◎	◎	×	◎	◎
02H: Device Y	◎	◎	×	◎	◎
03H: Buffer memory (1 word)	◎	◎	×	◎	◎
04H: Buffer memory (2 words)	◎	◎	×	◎	◎
05H: Positioning data No.	×	×	◎	×	×

◎ : One of the setting items must be set.

× : Setting not possible

REMARK

It is recommended that the "condition data" be set whenever possible with the AD75 software package. Execution by sequence program uses many sequence programs and devices. The execution becomes complicated, and the scan times will increase.

The setting requirements and details of the following "condition data" [Da.15] to [Da.18] setting items differ according to the "[Da.14] Condition target" setting. The following shows the [Da.15] to [Da.18] setting items corresponding to the "[Da.14] Condition target".

Other setting item [Da.14] setting item	[Da.15] Condition operator	[Da.16] Address	[Da.17] Parameter 1		[Da.18] Parameter 2	
01H: Device X	07H : DEV=ON	-	0H to FH (bit No.)		-	
02H: Device Y	08H : DEV=OFF		10H to 1FH (bit No.)			
03H: Buffer memory (1 word)	01H : **=P1 02H : **≠P1	Buffer memory address	P1 (numeric value)		P2 (numeric value) (Set only when [Da.15] is [05H] or [06H].)	
04H: Buffer memory (2 words)	03H : **≤P1 04H : **≥P1 05H : P1≤**≤P2 06H : **≤P1, P2≤**					
05H: Positioning data No.	09H : Axis 1 designation 0AH : Axis 2 designation 0BH : Axis 1 and axis 2 designation 0CH : Axis 3 designation	-	Low-order 16 bits	Axis 1 positioning data No.	Low-order 16 bits	Axis 3 positioning data No.
	0DH : Axis 1 and axis 3 designation 0EH : Axis 2 and axis 3 designation		High-order 16 bits	Axis 2 positioning data No.	High-order 16 bits	-

- : Setting not required (Setting value will be ignored. Use the initial value or a value within the setting range.)

** : Value stored in buffer memory designated in [Da.16].

REMARK

The "PLC CPU memory area" can be designated as the buffer memory address to be designated in "[Da.16]". (Refer to section "7.1.1 Configuration and roles of AD75 memory".)

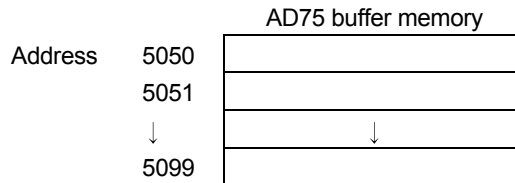

10.4.2 Condition data setting examples

The following shows setting examples for "condition data".

(1) Setting the device ON/OFF as a condition

[Condition] Device "X0" (=AD75 READY) is ON

Da.14 Condition target	Da.15 Condition operator	Da.16 Address	Da.17 Parameter 1	Da.18 Parameter 2
01H: Device X	07H: DEV=ON	-	0	-

(2) Setting the numeric value stored in the "buffer memory" as a condition

[Condition]

The value stored in buffer memory addresses "800, 801" (= "Md.29 Current feed value") is "1000" or larger.

Da.14 Condition target	Da.15 Condition operator	Da.16 Address	Da.17 Parameter 1	Da.18 Parameter 2
04H: Buffer memory (2 words)	03H: * * ≤ P1	800	1000	-

(3) Designating the axis and positioning data No. to be simultaneously started in "simultaneous start"

[Condition]

Simultaneously starting "axis 2 positioning data No.3".

Da.14 Condition target	Da.15 Condition operator	Da.16 Address	Da.17 Parameter 1	Da.18 Parameter 2
05H: Positioning data No.	0AH: Axis 2 designation	-	High-order 16 bits "0003H"	-

10.5 Start program for advanced positioning control

10.5.1 Starting advanced positioning control

To execute advanced positioning control, a sequence program must be created to start the control in the same manner as for main positioning control.

The following shows the procedure for starting the "1st point start block data" (regarded as block No. 7000) set in axis 1.

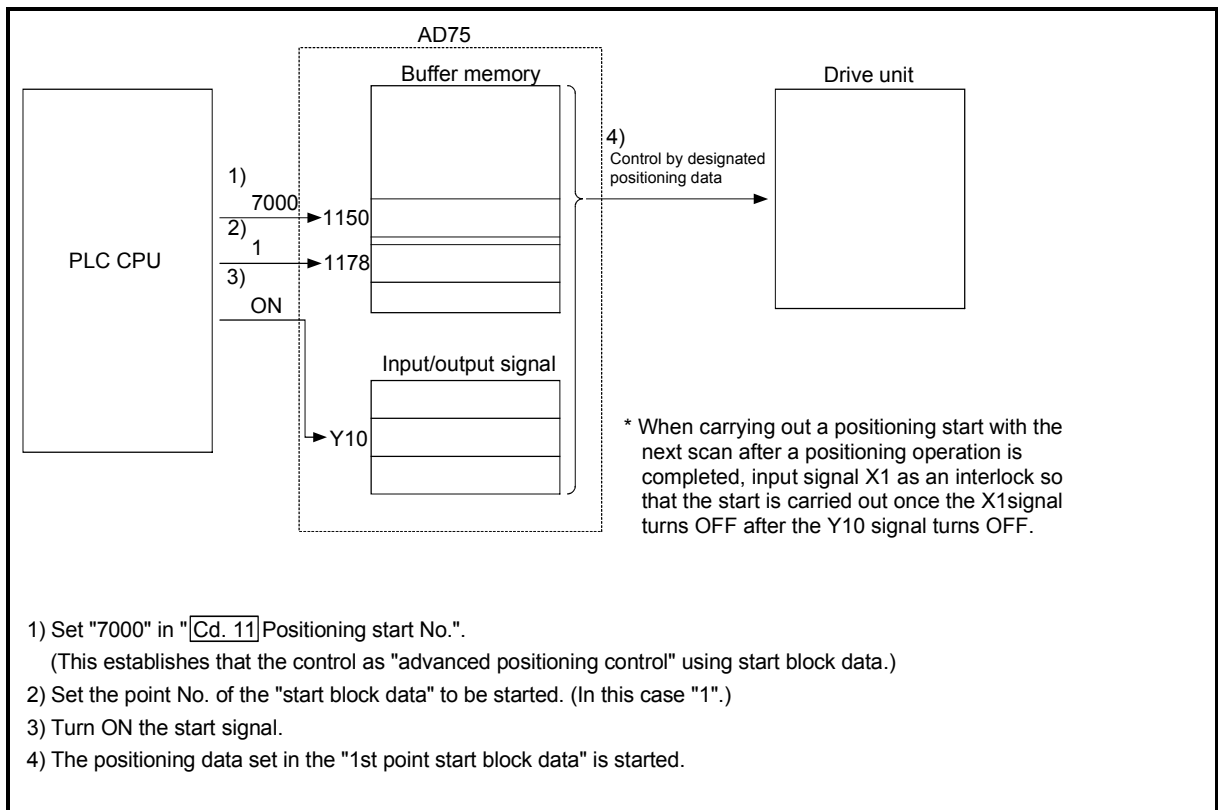

Fig. 10.2 Advanced positioning control start procedure

10.5.2 Example of a start program for advanced positioning control

The following shows an example of a start program for advanced positioning control in which the 1st point "start block data" of axis 1 is started. (The block No. is regarded as "7000".)

■ Control data that require setting

The following control data must be set to execute advanced positioning control. The setting is carried out using a sequence program.

Setting item	Setting value	Setting details	Buffer memory address			
			Axis 1	Axis 2	Axis 3	
Cd.11	Positioning start No.	7000	Set "7000" to indicate control using "start block data". Note that "7000" to "7010" can be set when setting the "7001" to "7010" data using the AD75 software package.	1150	1200	1250
Cd.31	Positioning starting point No.	1	Set the point No. of the "start block data" to be started.	1178	1228	1278

* Refer to section "5.7 List of control data" for details on the setting details.

■ Start conditions

The following conditions must be fulfilled when starting the control. The required conditions must also be integrated into the sequence program, and configured so the control does not start unless the conditions are fulfilled.

Signal name	Signal state	Device					
		Axis 1	Axis 2	Axis 3			
Interface signal	PLC READY signal	ON	PLC CPU preparation completed		Y1D		
	AD75 READY signal	OFF	AD75 preparation completed		X0		
	Axis stop signal	OFF	Axis stop signal is OFF		Y13	Y14	Y1C
	Start complete signal	OFF	Start complete signal is OFF		X1	X2	X3
	BUSY signal	OFF	BUSY signal is OFF		X4	X5	X6
	Error detection signal	OFF	There is no error		XA	XB	XC
	M code ON signal	OFF	M code ON signal is OFF		XD	XE	XF
External signal	Drive unit READY signal	ON	Drive unit preparation completed		-		
	Stop signal	OFF	Stop signal is OFF		-		
	Upper limit (FLS)	ON	Within limit range		-		
	Lower limit (RLS)	ON	Within limit range		-		

■ Start time chart

The following chart shows a time chart in which the positioning data 1, 2, 10, 11, and 12 of axis 1 are continuously executed as an example.

(a) Start block data setting example

Axis 1 start block data	Da.10 Shape	Da.11 Start data No.	Da.12 Special start command	Da.13 Parameter
1st point	1: Continue	1	0: Normal start	—
2nd point	0: End	10	0: Normal start	—
•				
•				

(b) Positioning data setting example

Axis 1 positioning data No.	Da.1 Operation pattern
1	01: Continuous positioning control
2	00: Positioning complete
•	
10	11: Continuous path control
11	11: Continuous path control
12	00: Positioning complete
•	

(c) Start time chart

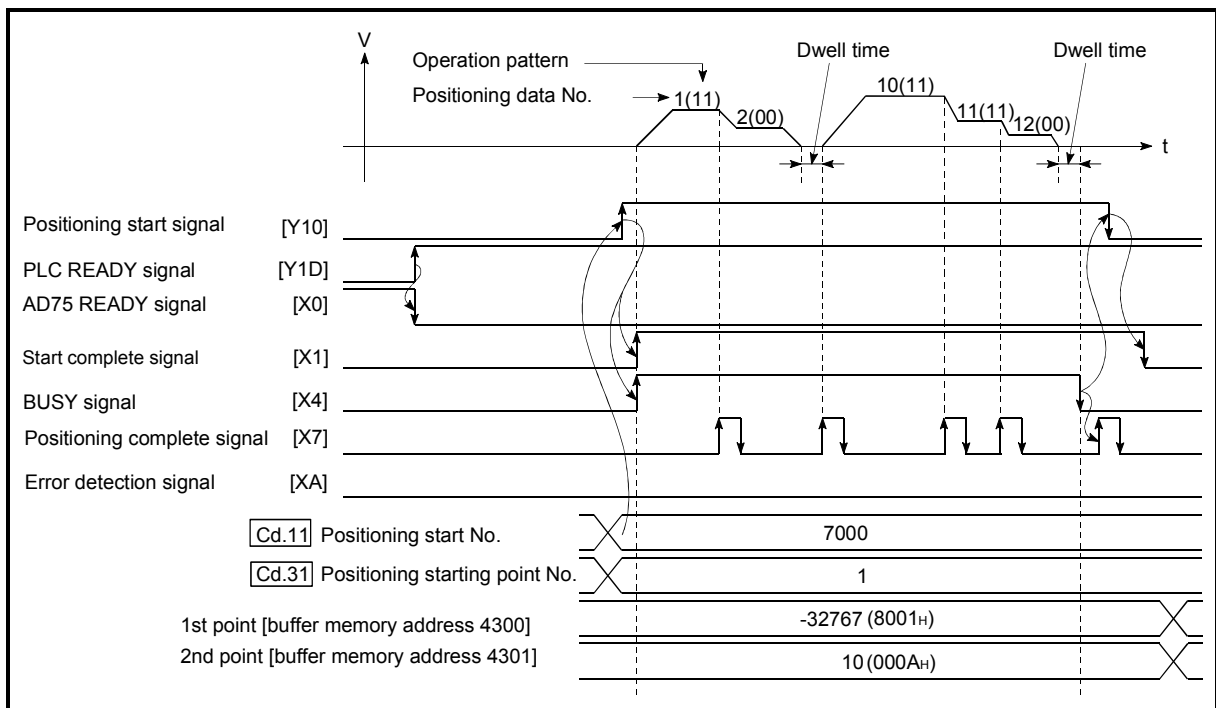
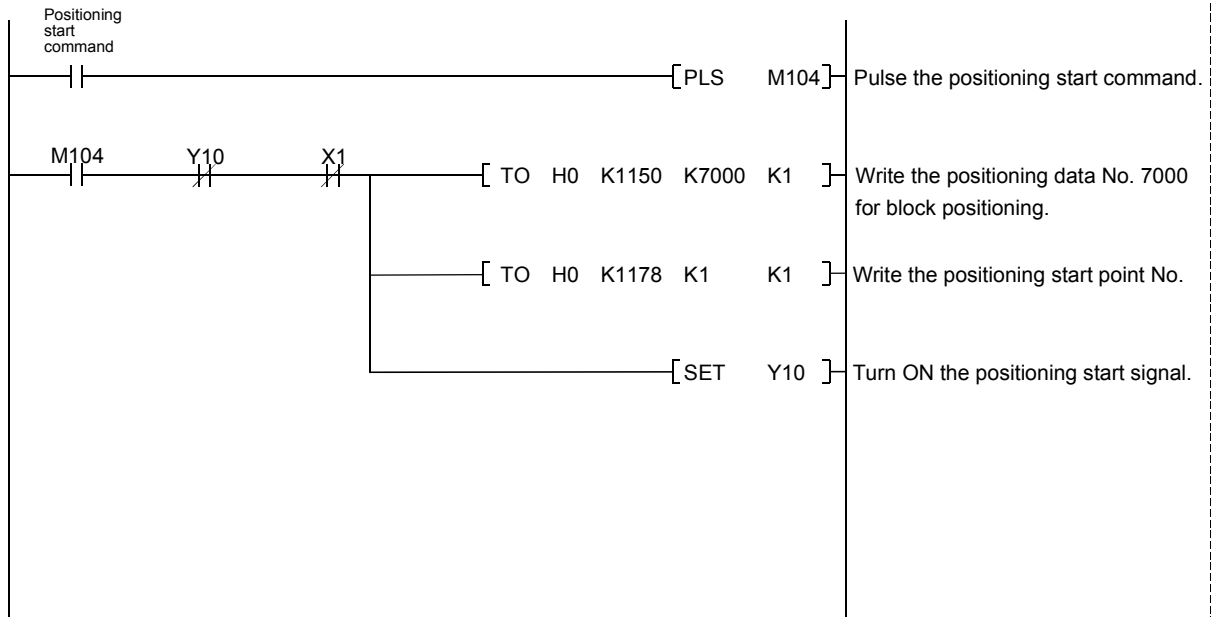

Fig. 10.3 Start time chart for advanced positioning control (block start)

■ Creating the program

Example

Set the start block data beforehand.



Y10 : Positioning start signal
 X1 : Start complete signal
 M104 : Positioning start command pulse

Chapter 11

MANUAL CONTROL

The details and usage of manual control are explained in this chapter.

In manual control, pulse output commands are issued during a JOG operation executed by the turning ON of the JOG START signal, or from a manual pulse generator connected to the AD75.

Manual control using a sequence program from the PLC CPU is explained in this chapter. Refer to the AD75 Software Package Operating Manual for an explanation of manual control (JOG operation, manual pulse generator operation) using the AD75 software package.

11.1	Outline of manual control	11- 2
11.1.1	Two manual control methods	11- 2
11.2	JOG operation.....	11- 4
11.2.1	Outline of JOG operation	11- 4
11.2.2	JOG operation execution procedure	11- 7
11.2.3	Setting the required parameters for JOG operation	11- 8
11.2.4	Creating start programs for JOG operation.....	11- 10
11.2.5	JOG operation example	11- 13
11.3	Manual pulse generator operation	11- 17
11.3.1	Outline of manual pulse generator operation.....	11- 17
11.3.2	Manual pulse generator operation execution procedure	11- 21
11.3.3	Setting the required parameters for manual pulse generator operation	11- 22
11.3.4	Creating a program to enable/disable the manual pulse generator operation	11- 23

11.1 Outline of manual control

11.1.1 Two manual control methods

"Manual control" refers to control in which positioning data is not used, and a positioning operation is carried out in response to signal input from an external source. The two types of this "manual control" are explained below.

(1) JOG operation

"JOG operation" is a control method in which the machine is moved by only a movement amount (pulses are continuously transmitted while the JOG START signal is ON). This operation is used to move the workpiece in the direction in which the limit signal is ON, when the operation is stopped by turning the limit signal OFF to confirm the positioning system connection and obtain the positioning data address (refer to section "12.6.4 Teaching function").

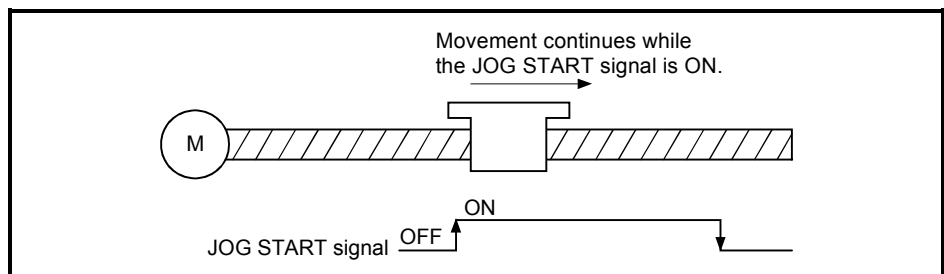

Fig. 11.1 JOG operation

(2) Manual pulse generator operation

"Manual pulse generator operation" is a control method in which positioning is carried out in response to the No. of pulses input from a manual pulse generator (the No. of input pulses is output). This operation is used for manual fine adjustment, etc., when carrying out accurate positioning to obtain the positioning address.

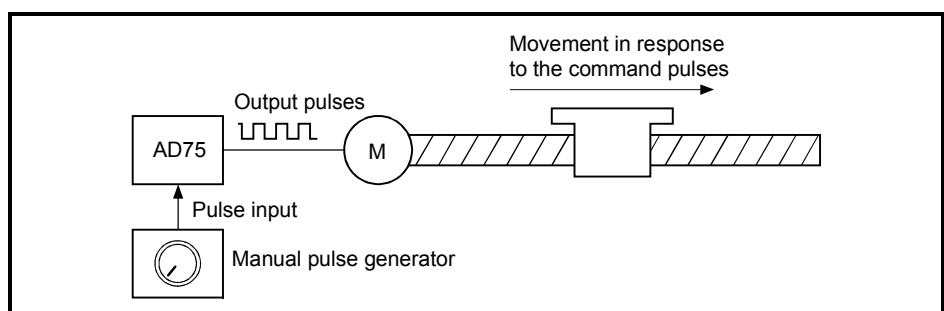

Fig. 11.2 Manual pulse generator control

■ Manual control auxiliary functions

Refer to section "3.3.4 Combination of AD75 main functions and auxiliary functions" for details on "auxiliary functions" that can be combined with manual control. Also refer to "Chapter 12 CONTROL AUXILIARY FUNCTIONS" for details on each auxiliary function.

■ Carrying out manual control from peripheral devices

"JOG operation" and enabling/disabling of the "manual pulse generator operation" can be executed from the AD75 software package test mode. Refer to the AD75 Software Package Operating Manual for details on manual control from the AD75 software package.

■ Monitoring manual control

Refer to section "5.6 List of monitor data" when directly monitoring the buffer memory using the GPP function software package. Also refer to the AD75 Software Package Operating Manual when monitoring with the monitor functions of the AD75 software package.

11.2 JOG operation

11.2.1 Outline of JOG operation

Important

Use the hardware stroke limit function when carrying out JOG operation near the upper or lower limits. (Refer to section 12.4.4).

* If the hardware stroke limit function is not used, the workpiece may exceed the operating range, causing an accident.

■ JOG operation

In JOG operation, the Forward run JOG start signal (Y16, Y18, Y1A) or Reverse run JOG start signal (Y17, Y19, Y1B) turns ON, causing pulses to be output to the drive unit from the AD75 while the signal is ON. The workpiece is then moved in the designated direction.

The following shows examples of JOG operation.

1)	When the START signal turns ON, acceleration begins in the direction designated by the START signal, and continues for the acceleration time designated in "[Pr.33] JOG operation acceleration time selection". At this time, the BUSY signal changes from OFF to ON.
2)	When the workpiece being accelerated reaches the speed set in "[Cd.19] JOG speed", the movement continues at this speed. Constant speed operation takes place at 2) and 3).
3)	When the START signal is turned OFF, deceleration begins from the speed set in "[Cd.19] JOG speed", and continues for the deceleration time designated in "[Pr.34] JOG operation deceleration time selection".
4)	The operation stops when the speed becomes 0. At this time, the BUSY signal changes from ON to OFF.

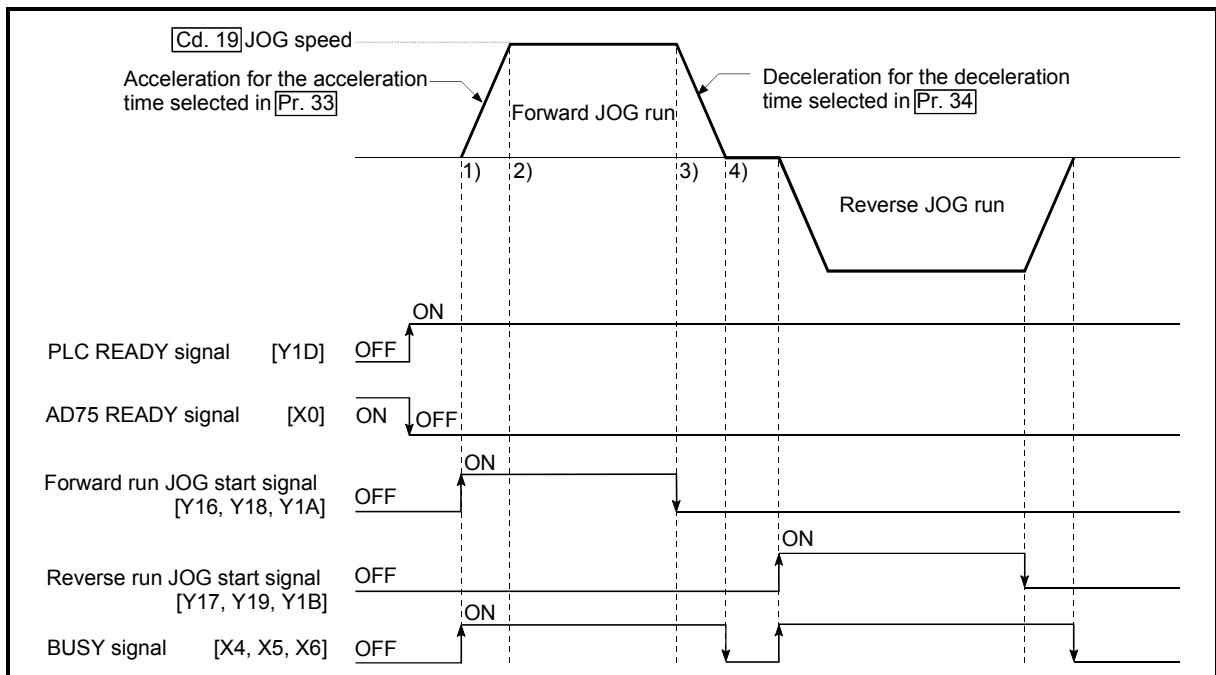

Fig. 11.3 JOG operation

■ Precautions during operation

The following details must be understood before carrying out JOG operation.

- (1) For safety, first set "[Cd.19] JOG speed" to a smaller value and check the movement. Then gradually increase the value.
- (2) If "[Cd.19] JOG speed" exceeds the speed set in "[Pr.32] JOG speed limit value", the workpiece will move at the "[Pr.32] JOG speed limit value" and a warning "JOG speed limit value" (warning code: 301) will occur in the AD75.
- (3) The JOG operation can be continued even if a warning "JOG speed limit value" (warning code: 301) has occurred.
- (4) A JOG start signal OFF → ON immediately after the stop signal ON → OFF (within 56.8ms) will be ignored. (The operation will not start.)

■ Errors during operation

When the operation is stopped by the stroke limit (limit signal OFF), JOG operation can be performed in the direction in which the limit signal turns ON after an error reset. (An error will occur again if the JOG start signal in the direction in which the limit signal turns OFF is turned ON.)

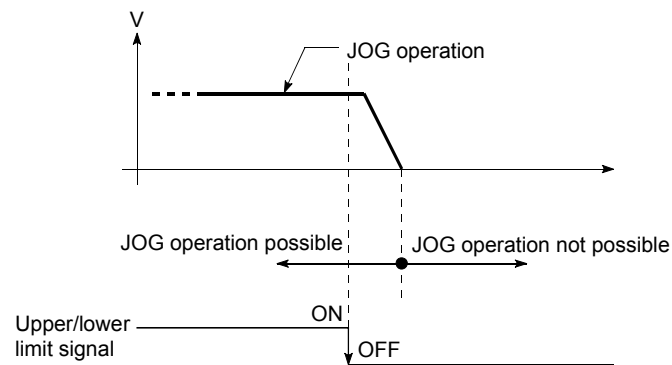

■ JOG operation timing and processing time

The following drawing shows details of the JOG operation timing and processing time.

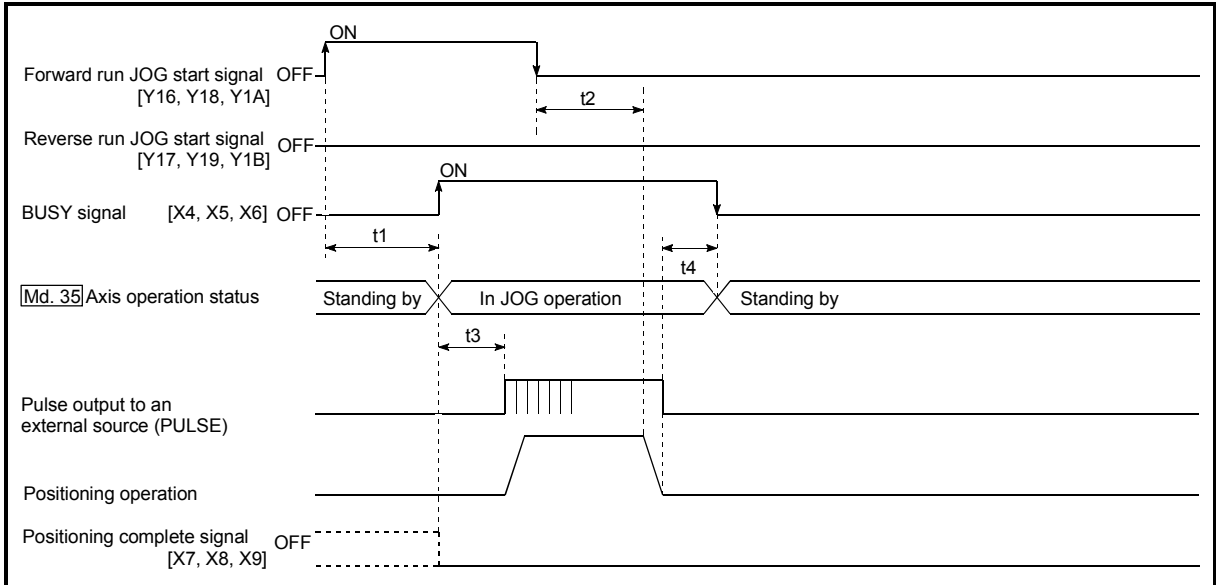

Fig. 11.4 JOG operation timing and processing times

Normal timing times

Unit: ms

t1	t2	t3	t4
1 to 60	0 to 3.5	6.5 to 10	0 to 3.5

- Delays may occur in the t1 timing time due to the following factors.
 - 1) Whether a FROM/TO command is issued during start processing.
 - 2) The operation status of other axes.
 - 3) Whether there is intervention from a peripheral device during start processing.
 - 4) Details of the positioning data to be started.

11.2.2 JOG operation execution procedure

The JOG operation is carried out by the following procedure.

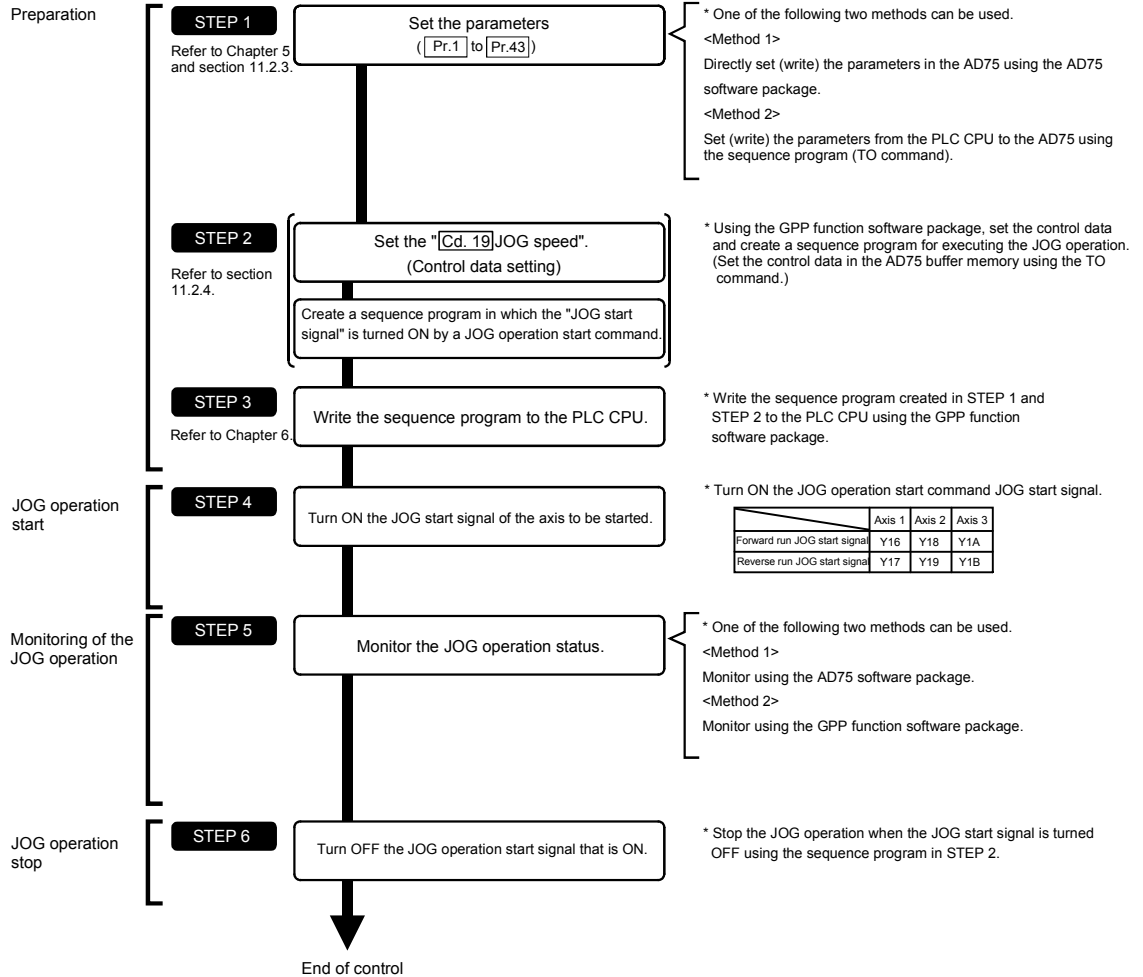

REMARK

- Mechanical elements such as limit switches are considered as already installed.
- Parameter settings work in common for all control using the AD75.

11.2.3 Setting the required parameters for JOG operation

The "Parameters" must be set to carry out JOG operation.

The following table shows the setting items of the required parameters for carrying out JOG operation. When only JOG operation will be carried out, no parameters other than those shown below need to be set. (Use the initial values or setting values within a range where no error occurs for trouble-free operation.)

Setting item		Setting requirement	Factory-set initial value (setting details)	
Parameters	Pr.1	Unit setting	⊙	3 (pulse)
	Pr.2	No. of pulses per rotation (Ap) (Unit: pulse)	⊙	20000
	Pr.3	Movement amount per rotation (Al) (Unit: pulse)	⊙	20000
	Pr.4	Unit magnification (Am)	⊙	1 (1-fold)
	Pr.5	Pulse output mode	⊙	1 (CW/CCW mode)
	Pr.6	Rotation direction setting	⊙	0 (current value increases by forward run pulse output)
	Pr.7	Speed limit value (Unit: pulse/s)	⊙	200000
	Pr.8	Acceleration time 0 (Unit: ms)	⊙	1000
	Pr.9	Deceleration time 0 (Unit: ms)	⊙	1000
	Pr.10	Bias speed at start (Unit: pulse/s)	○	0
	Pr.11	Stepping motor mode selection	○	0 (standard mode)
	Pr.12	Backlash compensation amount (Unit: pulse)	○	0
	Pr.13	Software stroke limit upper limit value (Unit: pulse)	○	2147483647
	Pr.14	Software stroke limit lower limit value (Unit: pulse)	○	-2147483648
	Pr.15	Software stroke limit selection	○	0 (current feed value)
	Pr.16	Software stroke limit valid/invalid setting	○	0 (invalid)
	Pr.18	Torque limit setting value (Unit: %)	○	300
	Pr.24	Logic selection for pulse output to the drive unit	⊙	0 (positive logic)
Pr.25	Size selection for acceleration/deceleration time	○	0 (1 word type)	

⊙ : Setting always required.

○ : Set according to requirements (Leave set to the initial value when not used.)

REMARK

- Parameter settings work in common for all control using the AD75. When carrying out other control ("main positioning control", "advanced positioning control", "zero point return positioning control"), the respective setting items must also be matched and set.
- Parameters are set for each axis.
- Refer to "Chapter 5 DATA USED FOR POSITIONING CONTROL" for setting details.

Setting item		Setting requirement	Factory-set initial value (setting details)	
Parameters	Pr.26	Acceleration time 1 (Unit: ms)	○	1000
	Pr.27	Acceleration time 2 (Unit: ms)	○	1000
	Pr.28	Acceleration time 3 (Unit: ms)	○	1000
	Pr.29	Deceleration time 1 (Unit: ms)	○	1000
	Pr.30	Deceleration time 2 (Unit: ms)	○	1000
	Pr.31	Deceleration time 3 (Unit: ms)	○	1000
	Pr.32	JOG speed limit value	◎	2000
	Pr.33	JOG operation acceleration time selection	◎	0 (acceleration time 0)
	Pr.34	JOG operation deceleration time selection	◎	0 (deceleration time 0)
	Pr.35	Acceleration/deceleration process selection	○	0 (automatic trapezoidal acceleration/deceleration processing)
	Pr.36	S-curve ratio	○	100
	Pr.37	Sudden stop deceleration time	○	1000
	Pr.38	Stop group 1 sudden stop selection	○	0 (deceleration stop)
	Pr.39	Stop group 2 sudden stop selection	○	0 (deceleration stop)
	Pr.40	Stop group 3 sudden stop selection	○	0 (deceleration stop)
	Pr.43	External start function selection	○	0 (positioning start)

◎ : Setting always required.

○ : Set according to requirements (Leave set to the initial value when not used.)

11.2.4 Creating start programs for JOG operation

A sequence program must be created to execute a JOG operation. Consider the "required control data setting", "start conditions", "start time chart", and "device settings" when creating the program.

The following shows an example when a JOG operation is started for axis 1. ("Cd.19 JOG speed" is set to "20000.00mm/min" in the example shown.)

■ Required control data setting

The control data shown below must be set to execute a JOG operation. The setting is carried out with the sequence program.

Setting item	Setting value	Setting details	Buffer memory address		
			Axis 1	Axis 2	Axis 3
Cd.19 JOG speed	2000000	Set a value equal to or above the "Pr.10 Bias speed at start" and equal to or below the "Pr.32 JOG speed limit value".	1160 1161	1210 1211	1260 1261

* Refer to section "5.7 List of control data" for details on the setting details.

■ Start conditions

The following conditions must be fulfilled when starting. The required conditions must also be assembled in the sequence program, and the sequence program must be configured so the operation will not start if the conditions are not fulfilled.

Signal name	Signal state	Device					
		Axis 1	Axis 2	Axis 3			
Interface signal	PLC READY signal	ON	PLC CPU preparation completed		Y1D		
	AD75 READY signal	OFF	AD75 preparation completed		X0		
	Axis stop signal	OFF	Axis stop signal is OFF		Y13	Y14	Y1C
	Start complete signal	OFF	Start complete signal is OFF		X1	X2	X3
	BUSY signal	OFF	BUSY signal is OFF		X4	X5	X6
	Error detection signal	OFF	There is no error		XA	XB	XC
	M code ON signal	OFF	M code ON signal is OFF		XD	XE	XF
External signal	Drive unit READY signal	ON	Drive unit preparation completed		-		
	Stop signal	OFF	Stop signal is OFF		-		
	Upper limit (FLS)	ON	Within limit range		-		
	Lower limit (RLS)	ON	Within limit range		-		

■ Start time chart

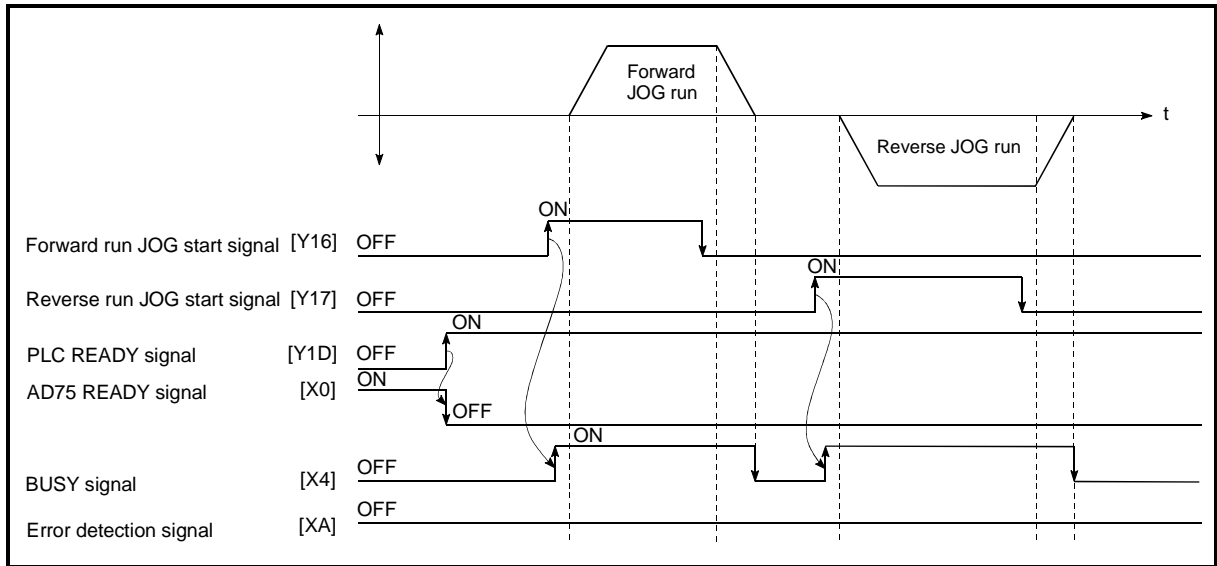
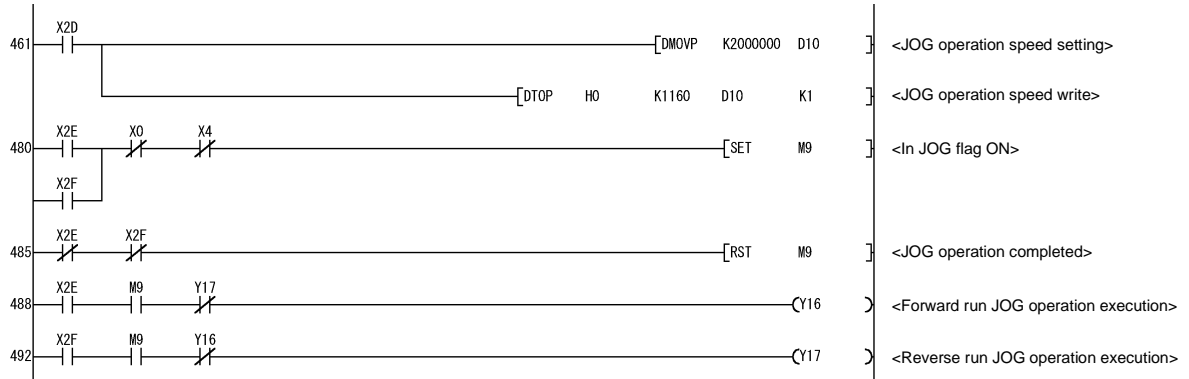

Fig. 11.5 JOG operation start time chart

■ Creating the program

Example

*
* No. 11 JOG operation program
*



11.2.5 JOG operation example

■ When the "stop signal" is turned ON during JOG operation

When the "stop signal" is turned ON during JOG operation, the JOG operation will stop by the "deceleration stop" method.
 JOG start signals will be ignored while the stop signal is ON.
 The operation can be started by turning the stop signal OFF, and turning the JOG start signal from OFF to ON again.

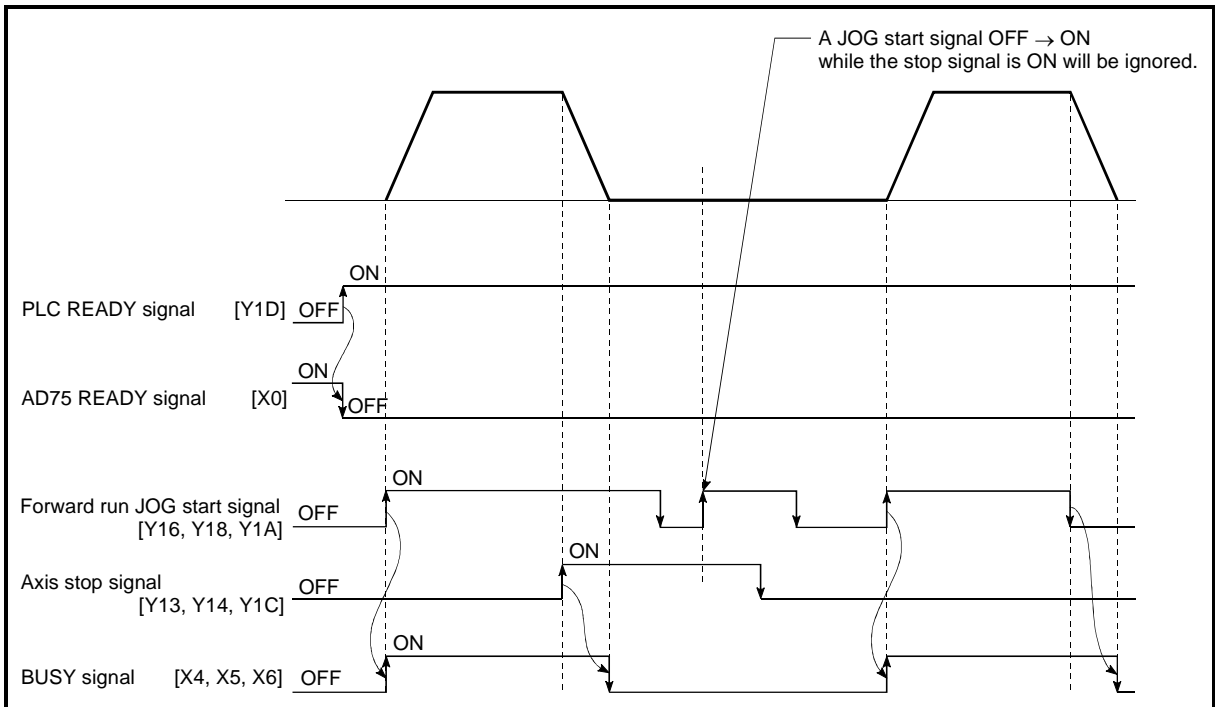

Fig. 11.6 Operation when the stop signal is turned ON during JOG operation

POINT
 The AD75 will not receive a "JOG start signal" while the "stop signal" is ON.

- When both the "forward run JOG start signal" and "reverse run JOG start signal" are turned ON simultaneously for one axis

When both the "forward run JOG start signal" and "reverse run JOG start signal" are turned ON simultaneously for one axis, the "forward run JOG start signal" is given priority. In this case, the "reverse run JOG start signal" is validated when the AD75 BUSY signal is turned OFF.

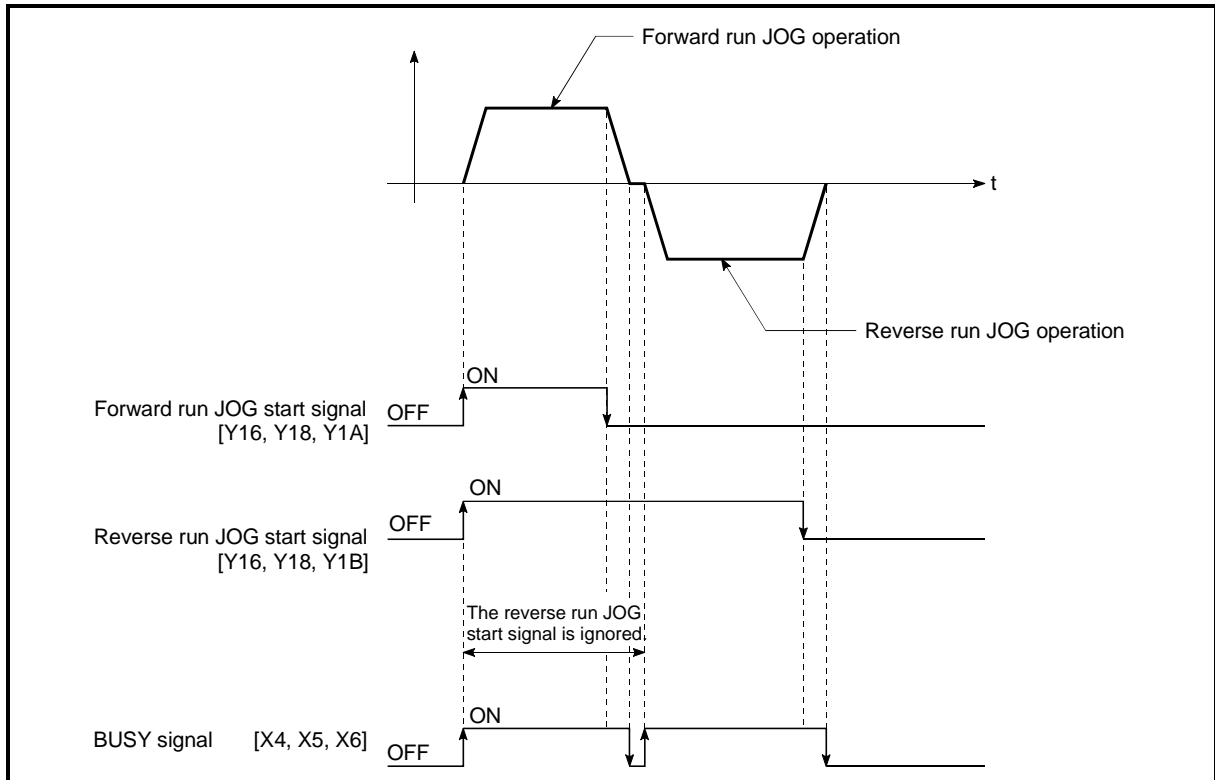

Fig. 11.7 Operation when both the forward run JOG start signal and reverse run JOG start signal are turned ON simultaneously

- When the "JOG start signal" is turned ON again during deceleration caused by the ON → OFF of the "JOG start signal"

When the "JOG start signal" is turned ON again during deceleration caused by the ON → OFF of the "JOG start signal", the JOG operation will be carried out from the time the "JOG start signal" is turned ON.

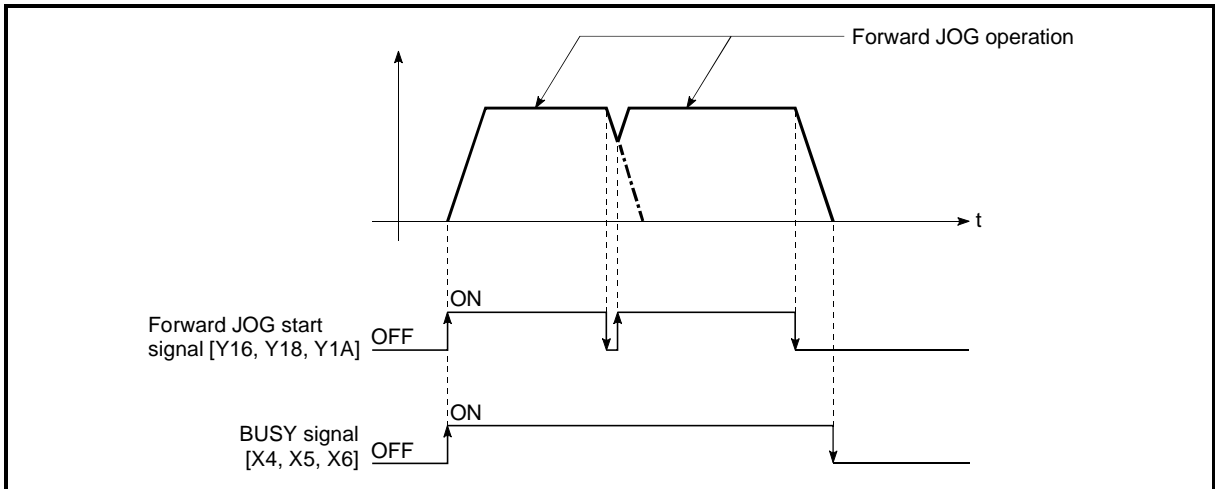

Fig. 11.8 Operation when the JOG start signal is turned ON during deceleration

- When the "JOG start signal" is turned ON during a peripheral device test mode

When the "JOG start signal" is turned ON during a peripheral device test mode, it will be ignored and the JOG operation will not be carried out.

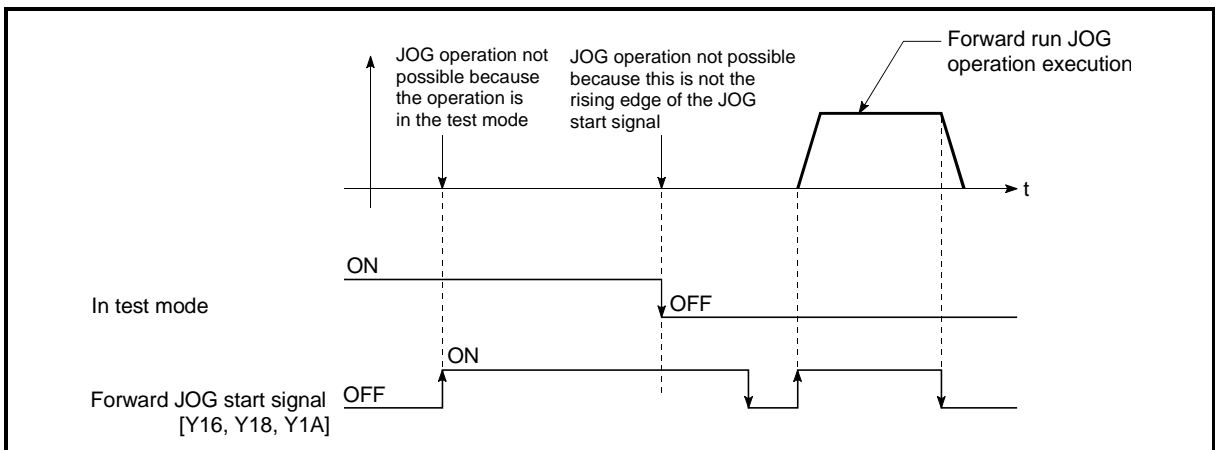

Fig. 11.9 Operation when the JOG start signal is turned ON during a test mode

- When the "JOG start signal" is turned ON immediately after the stop signal OFF (within 56.8ms)

When the "JOG start signal" is turned ON immediately after the stop signal OFF (within 56.8ms), it will be ignored and the JOG operation will not be carried out.

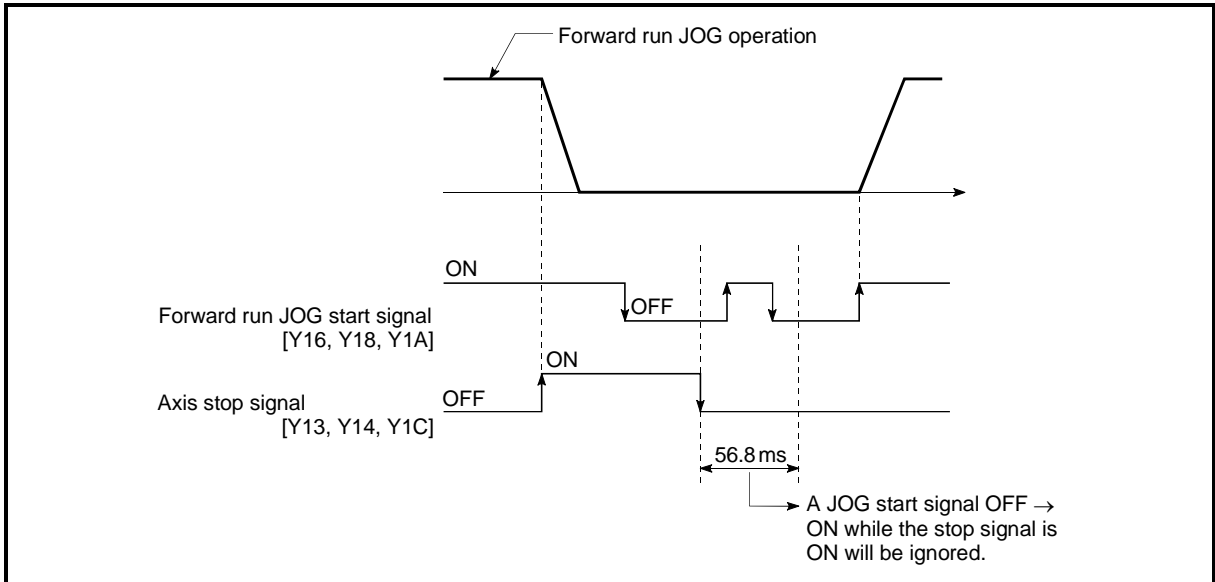

Fig. 11.10 Operation when the JOG start signal is turned ON immediately after the stop signal OFF

11.3 Manual pulse generator operation

11.3.1 Outline of manual pulse generator operation

Important

Create the sequence program so that "[Cd.22] Manual pulse generator enable flag" is always set to "0" (disabled) when a manual pulse generator operation is not carried out.

* Mistakenly touching the manual pulse generator when the manual pulse generator enable flag is set to "1" (enable) can cause accidents or incorrect positioning.

■ Manual pulse generator operation

In manual pulse generator operations, pulses are input to the AD75 from the manual pulse generator. This causes the same No. of input pulses to be output from the AD75 to the servo amplifier, and the workpiece is moved in the designated direction.

The following shows an example of manual pulse generator operation.

- | | |
|----|--|
| 1) | When the "[Cd.22] Manual pulse generator enable flag" is set to "1", the BUSY signal turns ON and the manual pulse generator operation is enabled. |
| 2) | The workpiece is moved corresponding to the No. of pulses input from the manual pulse generator. |
| 3) | The workpiece movement stops when no more pulses are input from the manual pulse generator. |
| 4) | When the "[Cd.22] Manual pulse generator enable flag" is set to "0", the BUSY signal turns OFF and the manual pulse generator operation is disabled. |

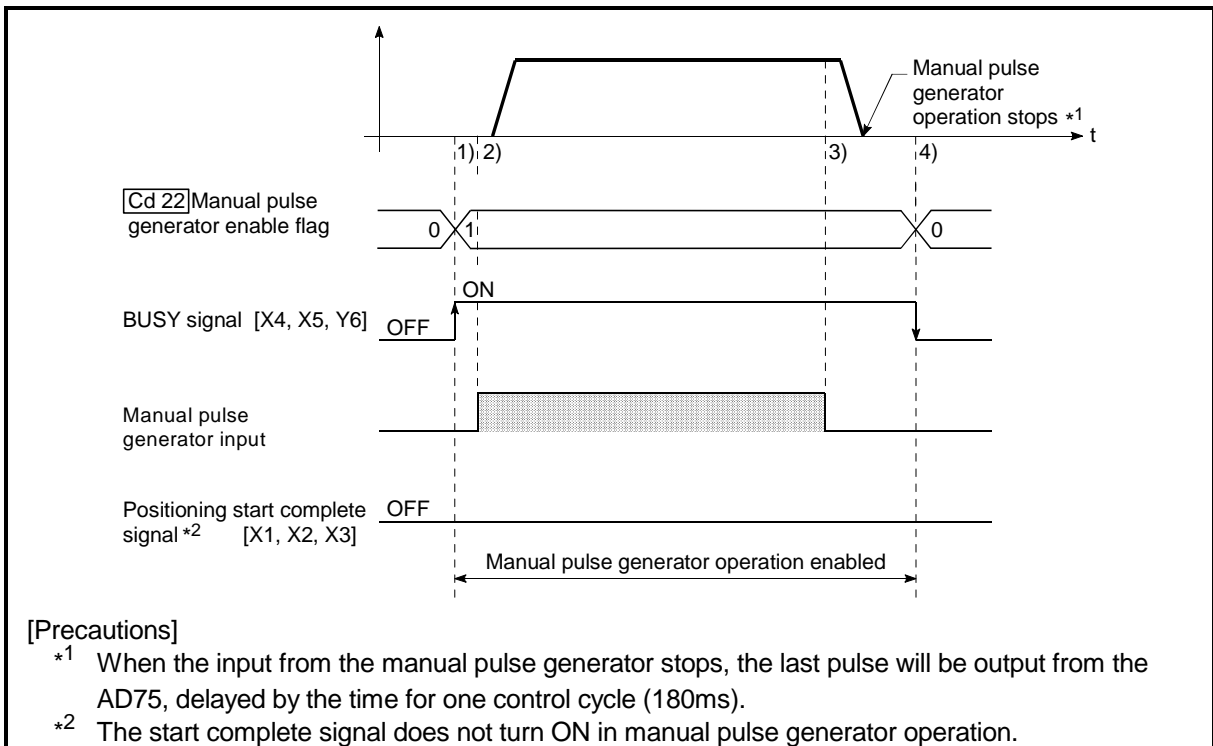

Fig. 11.11 Manual pulse generator operation

■ Restricted items

A manual pulse generator is required to carry out manual pulse generator operation.

■ Precautions during operation

The following details must be understood before carrying out manual pulse generator operation.

- (1) The speed during manual pulse generation operation is not limited by the "[Pr.7] Speed limit value".
- (2) If the "[Cd.22] Manual pulse generator enable flag" is turned ON while the AD75 is BUSY (BUSY signal ON), a warning "Start during operation" (warning code: 100) will occur.
- (3) If a stop factor occurs during manual pulse generator operation, the operation will stop, and the BUSY signal will turn OFF. At this time, the "[Cd.22] Manual pulse generator enable flag" will be left ON, but manual pulse generator operation will not be possible. To carry out manual pulse generator operation again, measures must be carried out to eliminate the stop factor. Once eliminated, the operation can be carried out again by turning the "[Cd.22] Manual pulse generator enable flag" ON → OFF → ON.
- (4) Pulses will not be output if an error occurs when the manual pulse generator operation starts.

REMARK

- One AD75 module can be connected to each manual pulse generator axis.
- The AD75 module can simultaneously output pulses to the axis 1 to axis 3 drive units by one manual pulse generator.
(1-axis to 3-axis simultaneous operation is possible.)

■ Errors during operation

When the operation is stopped by the stroke limit (limit signal OFF), manual pulse generator operation can be performed in the direction in which the limit signal turns ON after an error reset. (An error will occur again if pulse input is provided in the direction in which the limit signal turns OFF is turned ON.)

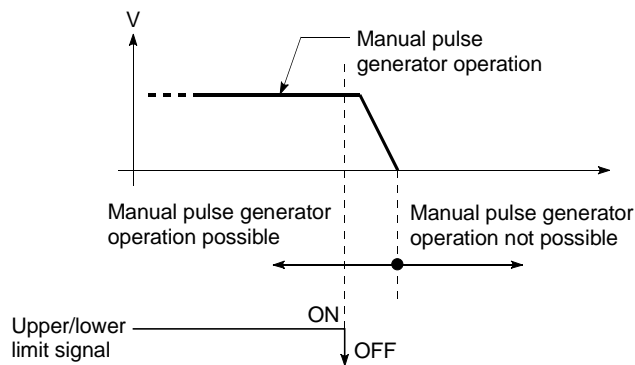

Manual pulse generator operation timing and processing time

The following drawing shows details of the manual pulse generator operation timing and processing time.

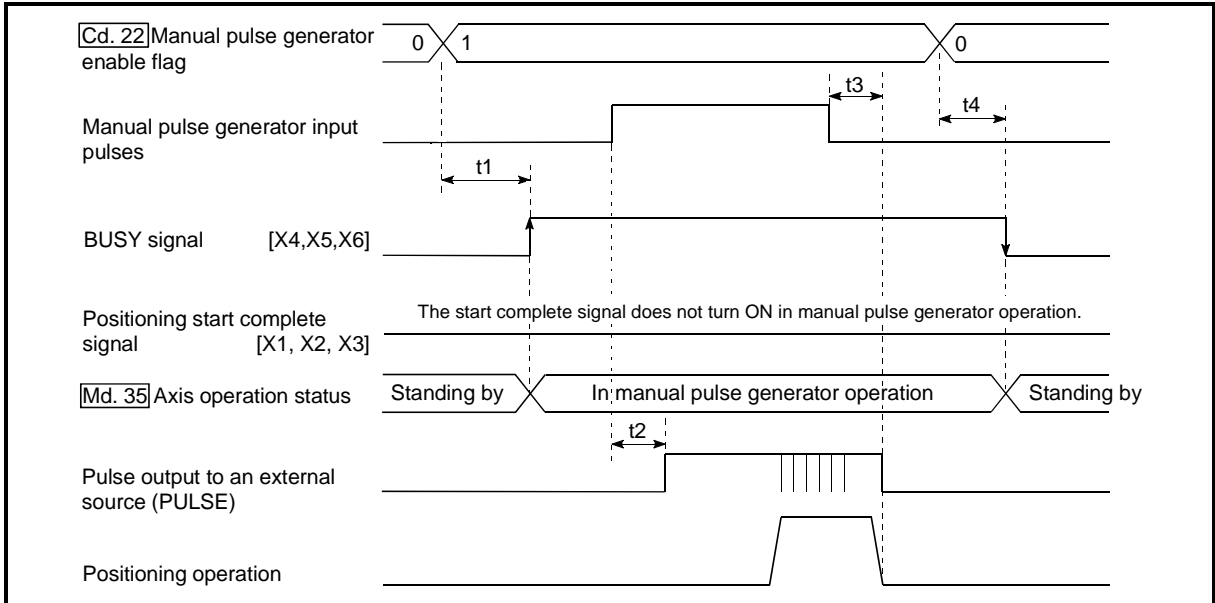

Fig. 11.12 Manual pulse generator operation timing and processing times

Normal timing times

Unit : ms

t1	t2	t3	t4
1 to 60	0 to 60	120 to 180	1 to 60

- Delays may occur in the t1 timing time due to the following factors.
 - Whether a FROM/TO command is issued during start processing.
 - The operation status of other axes.
 - Whether there is intervention from a peripheral device during processing the start process.
 - Details of the positioning data to be started.

■ Position control by manual pulse generator operation

The command output during manual pulse generator operation is as follows.

$$[\text{No. of command pulses}] = [\text{No. of manual pulse generator input pulse}] \times [\text{Cd.23 Manual pulse generator 1 pulse input magnification}]$$

$$[\text{Command speed}^*] = [\text{Manual pulse generator input frequency}] \times [\text{Cd.23 Manual pulse generator 1 pulse input magnification}]$$

*: When the manual pulse generator input frequency changes, the new frequency will apply after a maximum of 180ms delay.

11.3.2 Manual pulse generator operation execution procedure

The manual pulse generator operation is carried out by the following procedure.

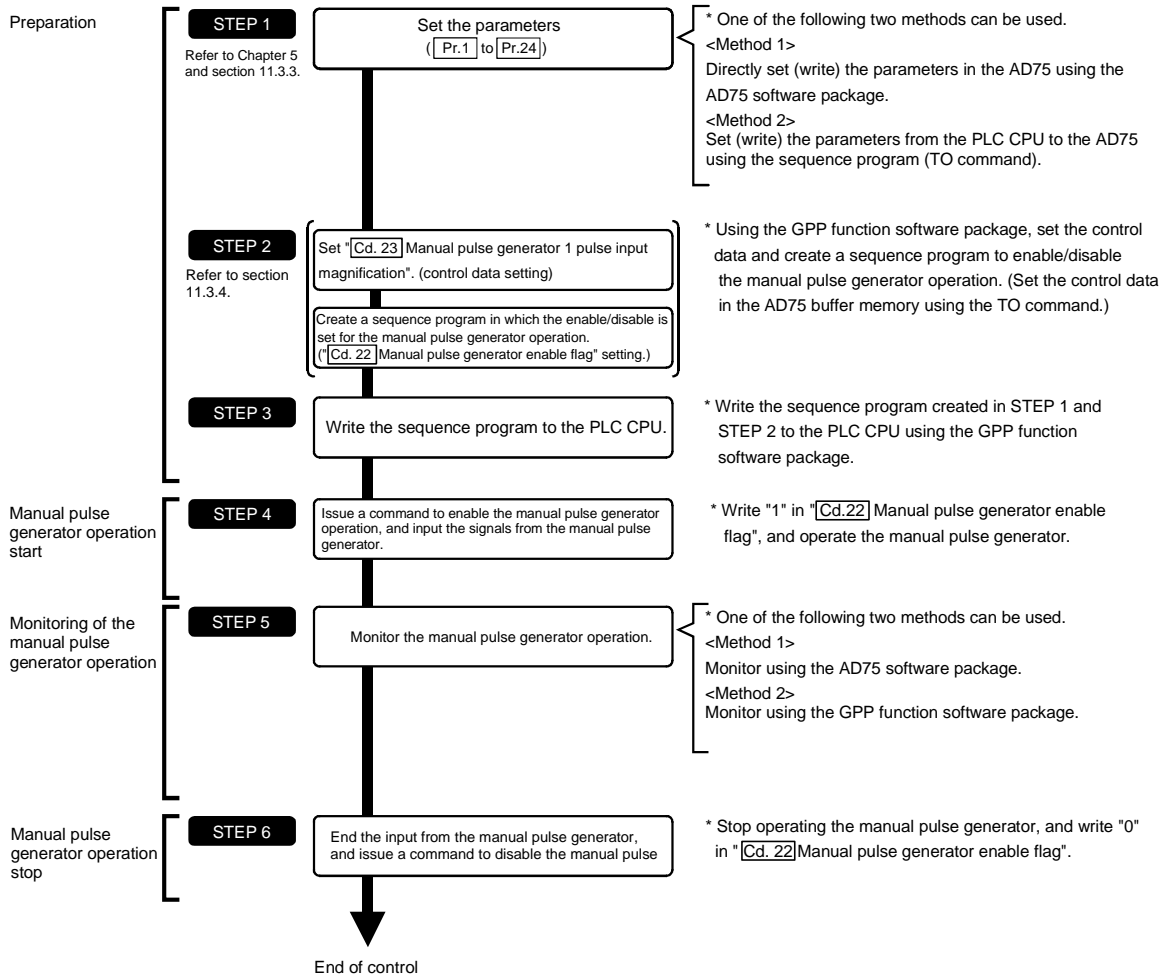

REMARK

- Mechanical elements such as limit switches are considered as already installed.
- Parameter settings work in common for all control using the AD75.

11.3.3 Setting the required parameters for manual pulse generator operation

The "Parameters" must be set to carry out manual pulse generator operation. The following table shows the setting items of the required parameters for carrying out manual pulse generator operation. When only manual pulse generator operation will be carried out, no parameters other than those shown below need to be set. (Use the initial values or setting values within a range where no error occurs for trouble-free operation.)

Setting item		Setting requirement	Factory-set initial value (setting details)	
Parameters	Pr.1	Unit setting	⊙	3 (pulse)
	Pr.2	No. of pulses per rotation (Ap) (Unit: pulse)	⊙	20000
	Pr.3	Movement amount per rotation (Al) (Unit: pulse)	⊙	20000
	Pr.4	Unit magnification (Am)	⊙	1 (1-fold)
	Pr.5	Pulse output mode	⊙	1 (CW/CCW mode)
	Pr.6	Rotation direction setting	⊙	0 (current value increases by forward run pulse output)
	Pr.11	Stepping motor mode selection	○	0 (standard mode)
	Pr.12	Backlash compensation amount (Unit: pulse)	○	0
	Pr.13	Software stroke limit upper limit value (Unit: pulse)	○	2147483647
	Pr.14	Software stroke limit lower limit value (Unit: pulse)	○	-2147483648
	Pr.15	Software stroke limit selection	○	0 (current feed value)
	Pr.16	Software stroke limit valid/invalid setting	○	0 (invalid)
	Pr.18	Torque limit setting value (Unit: pulse)	○	300
	Pr.23	Manual pulse generator selection	⊙	Axis 1 = 1, axis 2 = 2, axis 3 = 3
	Pr.25	Logic selection for pulse output to the drive unit	⊙	0 (positive logic)

⊙ : Setting always required.

○ : Set according to requirements (Leave set to the initial value when not used.)

REMARK

- Parameter settings work in common for all control using the AD75. When carrying out other control ("main positioning control", "advanced positioning control", "zero point return positioning control"), the respective setting items must also be matched and set.
- Parameters are set for each axis.
- Refer to "Chapter 5 DATA USED FOR POSITIONING CONTROL" for setting details.

11.3.4 Creating a program to enable/disable the manual pulse generator operation

A sequence program must be created to execute a manual pulse generator operation. Consider the "required control data setting", "start conditions", "start time chart", and "device settings" when creating the program.

The following shows an example when a manual pulse generator operation is started for axis 1.

■ Required control data setting

The control data shown below must be set to execute a manual pulse generator operation. The setting is carried out with the sequence program.

Setting item		Setting value	Setting details	Buffer memory address		
				Axis 1	Axis 2	Axis 3
Cd.22	Manual pulse generator enable flag	1 (0)	Set "1: Enable manual pulse generator operation". (Set "0: Disable manual pulse generator operation" when finished with the manual pulse generator operation.)	1167	1217	1267
Cd.23	Manual pulse generator 1 pulse input magnification	1	Set the manual pulse generator 1 pulse input magnification.	1168 1169	1218 1219	1268 1269

* Refer to section "5.7 List of control data" for details on the setting details.

■ Start conditions

The following conditions must be fulfilled when starting. The required conditions must also be assembled in the sequence program, and the sequence program must be configured so the operation will not start if the conditions are not fulfilled.

Signal name		Signal state		Device		
				Axis 1	Axis 2	Axis 3
Interface signal	PLC READY signal	ON	PLC CPU preparation completed	Y1D		
	AD75 READY signal	OFF	AD75 preparation completed	X0		
	Axis stop signal	OFF	Axis stop signal is OFF	Y13	Y14	Y1C
	Start complete signal	OFF	Start complete signal is OFF	X1	X2	X3
	BUSY signal	OFF	BUSY signal is OFF	X4	X5	X6
	Error detection signal	OFF	There is no error	XA	XB	XC
	M code ON signal	OFF	M code ON signal is OFF	XD	XE	XF
External signal	Drive unit READY signal	ON	Drive unit preparation completed	-		
	Stop signal	OFF	Stop signal is OFF	-		
	Upper limit (FLS)	ON	Within limit range	-		
	Lower limit (RLS)	ON	Within limit range	-		

■ Start time chart

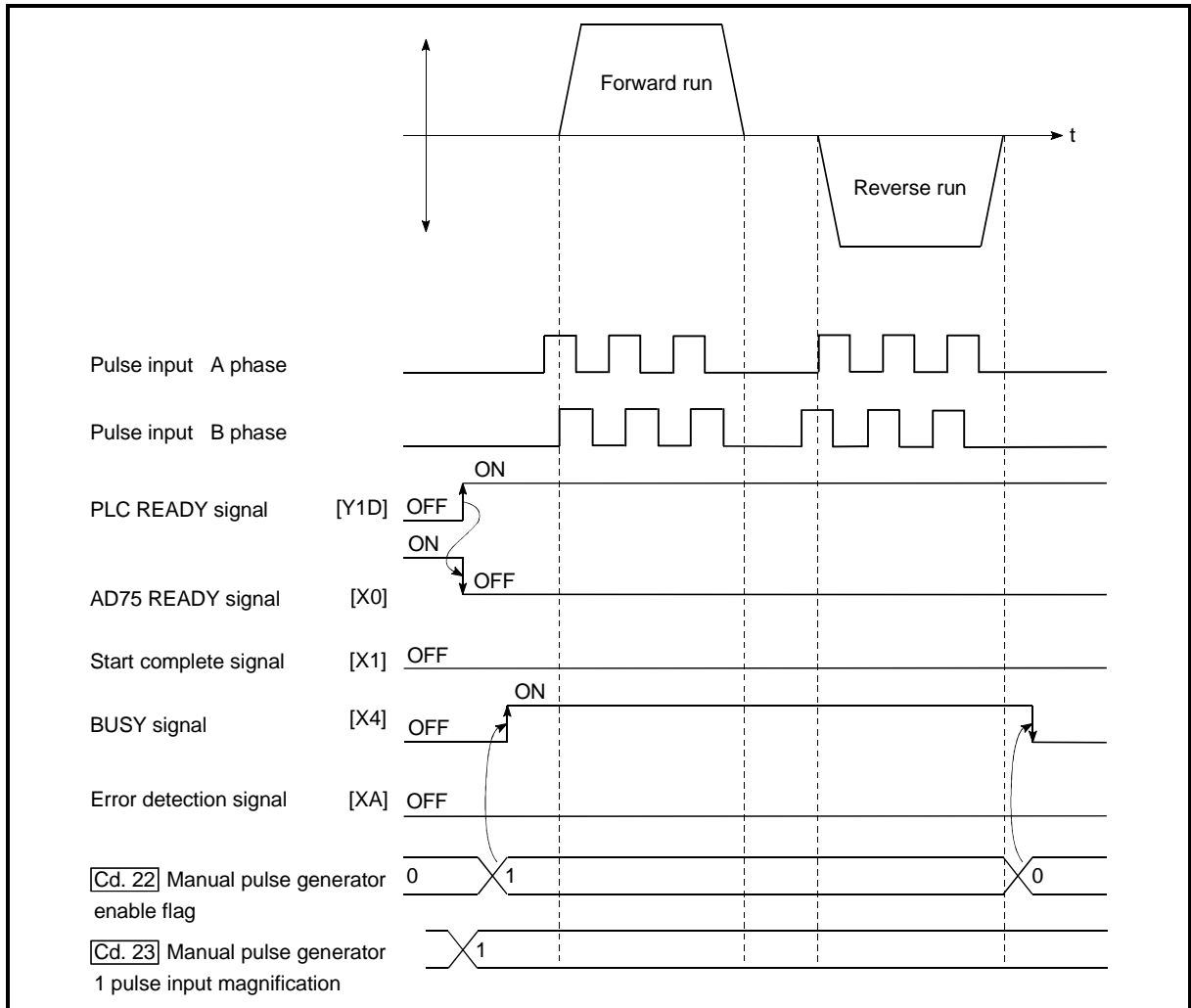
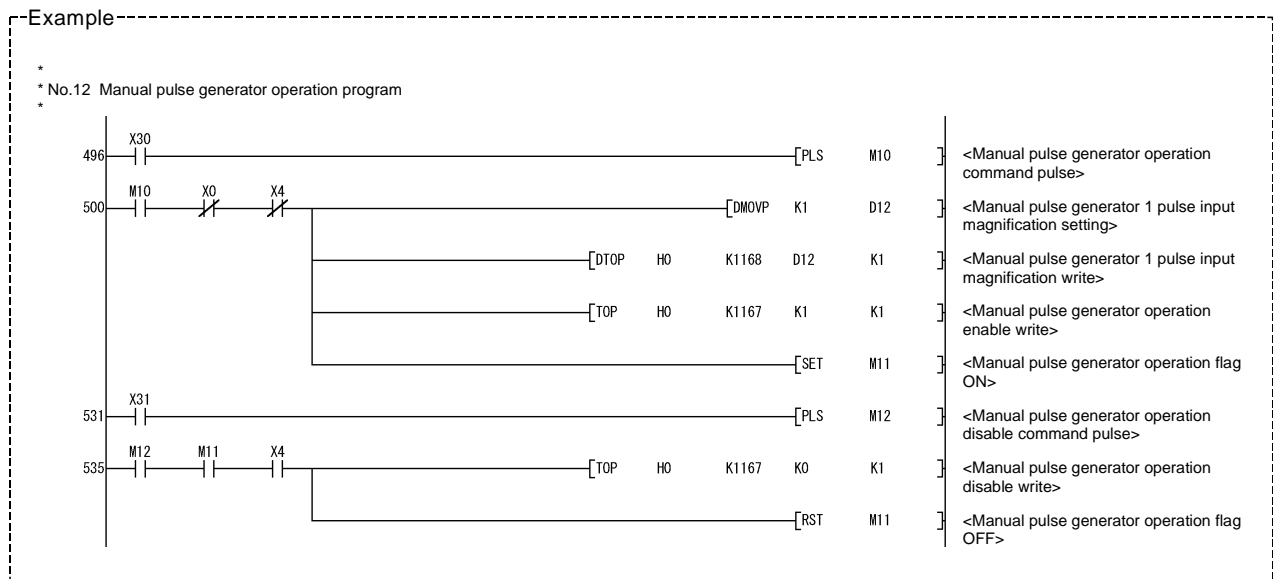

Fig. 11.13 Manual pulse generator operation start time chart

■ Creating the program



Chapter 12

CONTROL AUXILIARY FUNCTIONS

The details and usage of the "auxiliary functions" added and used in combination with the main functions are explained in this chapter.

A variety of auxiliary functions are available, including functions specifically for machine zero point returns and generally related functions such as control compensation, etc. More appropriate, finer control can be carried out by using these auxiliary functions. Each auxiliary function is used together with a main function by creating matching parameter settings and sequence programs. Read the execution procedures and settings for each auxiliary function, and set as required.

12.1	Outline of auxiliary functions	12- 2
12.1.1	Outline of auxiliary functions	12- 2
12.2	Auxiliary functions specifically for machine zero point returns.....	12- 4
12.2.1	Zero point return retry function	12- 4
12.2.2	Zero point shift function	12- 8
12.3	Functions for compensating the control.....	12- 11
12.3.1	Backlash compensation function.....	12- 11
12.3.2	Electronic gear function	12- 13
12.3.3	Near pass mode function.....	12- 18
12.4	Functions to limit the control.....	12- 22
12.4.1	Speed limit function.....	12- 22
12.4.2	Torque limit function.....	12- 24
12.4.3	Software stroke limit function.....	12- 27
12.4.4	Hardware stroke limit function	12- 33
12.5	Functions to change the control details	12- 35
12.5.1	Speed change function	12- 35
12.5.2	Override function	12- 42
12.5.3	Acceleration/deceleration time change function	12- 45
12.5.4	Torque change function	12- 48
12.6	Other functions.....	12- 50
12.6.1	Step function	12- 50
12.6.2	Skip function	12- 55
12.6.3	M code output function.....	12- 58
12.6.4	Teaching function.....	12- 62
12.6.5	Command in-position function	12- 72
12.6.6	Stepping motor mode function.....	12- 75
12.6.7	Acceleration/deceleration processing function.....	12- 78
12.6.8	Indirectly specification function	12- 82

12.1 Outline of auxiliary functions

"Auxiliary functions" are functions that compensate, limit, add functions, etc., to the control when the main functions are executed. These auxiliary functions are executed by parameter settings, commands from the AD75 software package, auxiliary function sequence programs, etc.

12.1.1 Outline of auxiliary functions

The following table shows the types of auxiliary functions available.

Auxiliary function		Details
Functions characteristic to machine zero point return	Zero point return retry function	This function retries the machine zero point return with the upper/lower limit switches during machine zero point return. This allows machine zero point return to be carried out even if the axis is not returned to before the near-point dog with JOG operation, etc.
	Zero point shift function	After returning to the machine zero point, this function offsets the position by the designated distance from the machine zero point position and sets that position as the zero point address.
Functions that compensate control	Backlash compensation function	This function compensates the mechanical backlash. Feed pulses equivalent to the set backlash amount are output each time the movement direction changes.
	Electronic gear function	By setting the movement amount per pulse, this function can freely change the machine movement amount per commanded pulse. When the movement amount per pulse is set, a flexible positioning system that matches the machine system can be structured.
	Near pass mode function	This function suppresses the machine vibration when the speed changes during continuous path control in the interpolation control.
Functions that limit control	Speed limit function	If the command speed exceeds "[Pr.7] Speed limit value" during control, this function limits the commanded speed to within the "[Pr.7] Speed limit value" setting range.
	Torque limit function *1	If the torque generated by the servomotor exceeds "[Pr.18] Torque limit setting value" during control, this function limits the generated torque to within the "[Pr.18] Torque limit setting value" setting range.
	Software stroke limit function	If a command outside of the upper/lower limit stroke limit setting range, set in the parameters, is issued, this function will not execute positioning for that command.
	Hardware stroke limit function	This function carries out deceleration stop with the limit switch connected to the AD75 external device connection connector.
Functions that change control details	Speed change function	This function changes the speed during positioning. Set the changed speed in the speed change buffer memory ([Cd.16] New speed value), and change the speed with the speed change request ([Cd.17] Speed change request).
	Override function	This function changes the speed within a percentage of 1 to 300% during positioning. This is executed using "[Cd.18] Positioning operation speed override".
	Acceleration/deceleration time change function	This function changes the acceleration/deceleration time during speed change.
	Torque change function	This function changes the "torque limit value" during control.

*1 To carry out "torque limit", the "D/A conversion module" and a "drive unit capable of the torque limit command with an analog voltage" must be prepared.

Auxiliary function	Details
Other functions	Step function This function temporarily stops the operation to confirm the positioning operation during debugging, etc. The operation can be stopped at each "automatic deceleration" or "positioning data".
	Skip function This function stops the positioning being executed (decelerates to a stop) when the skip signal is input, and carries out the next positioning.
	M code output function This function issues an auxiliary work (clamp or drill stop, tool change, etc.) according to the code No. (0 to 32767) set for each positioning data.
	Teaching function This function stores the address positioned with manual control into the positioning address (<u>Da.5</u> Positioning address/movement amount) having the designated positioning data No.
	Command in-position function At each automatic deceleration, this function calculates the remaining distance for the AD75 to reach the positioning stop position, and when the value is less than the set value, sets the "command in-position flag". When using another auxiliary work before ending the control, use this function as a trigger for the auxiliary work.
	Stepping motor mode function This function makes settings for using a stepping motor.
	Acceleration/deceleration process function This function adjusts the control acceleration/deceleration.
	Indirectly specification function This function specifies indirectly and starts the positioning data No.

12.2 Auxiliary functions specifically for machine zero point returns

The auxiliary functions specifically for machine zero point returns include the "zero point retry function" and "zero point shift function". Each function is executed by parameter setting.

12.2.1 Zero point return retry function

When the workpiece goes past the zero point without stopping during positioning control, it may not move back in the direction of the zero point although a machine zero point return is commanded, depending on the workpiece position. This normally means the workpiece has to be moved to a position before the near-point dog by a JOG operation, etc., to start the machine zero point return again. However, by using the zero point return retry function, a machine zero point return can be carried out regardless of the workpiece position.

The details shown below explain about the "zero point return retry function".

- (1) Control details
- (2) Precautions during control
- (3) Setting the zero point return retry function

(1) Control details

The following drawing shows the operation of the zero point return retry function.

- (a) Zero point return retry operation when the workpiece is within the range between the upper and lower limits.

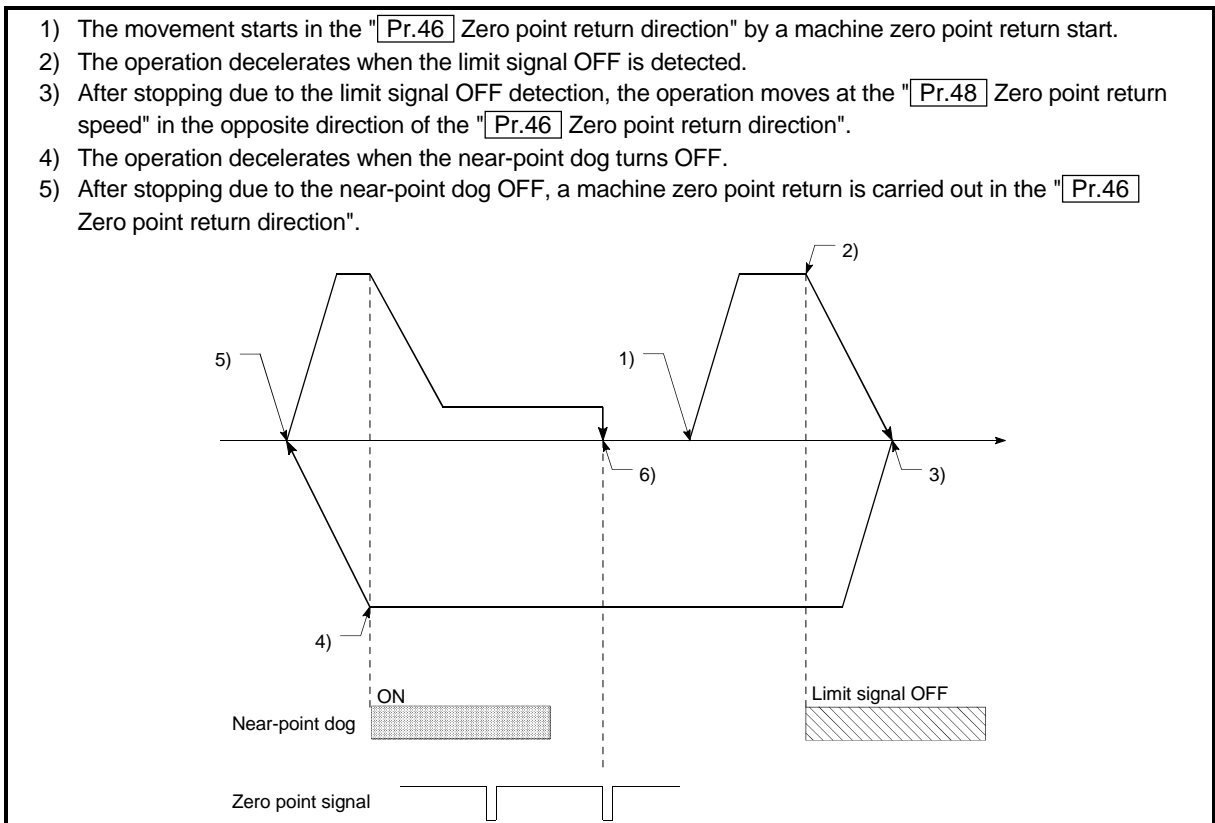

Fig. 12.1 Zero point return retry operation by limit signal detection

(b) Zero point return retry operation when the workpiece is outside the range between the upper and lower limits.

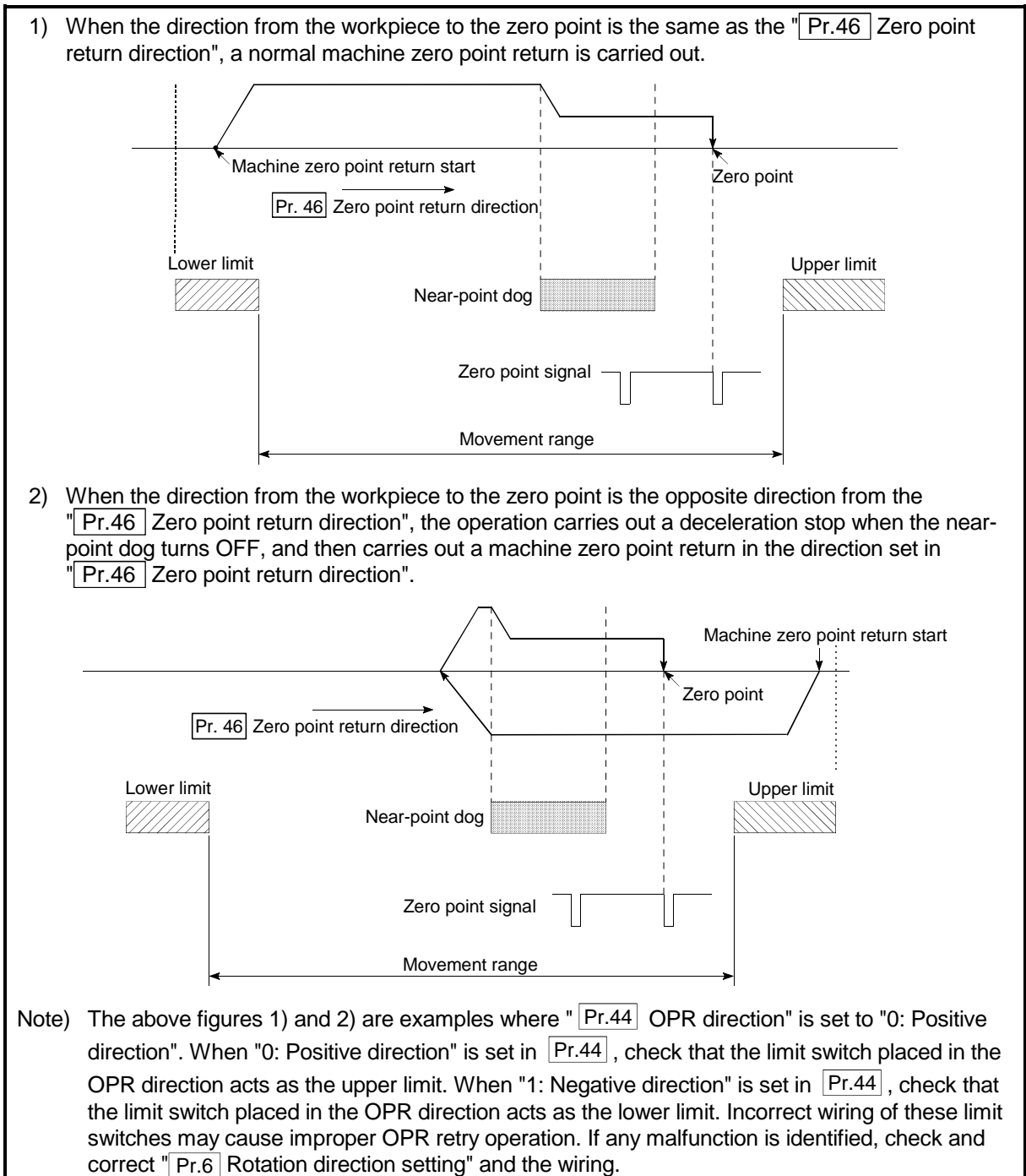

Fig. 12.2 Zero point return retry operation from on limit (limit signal OFF)

- (c) Setting the dwell time for a zero point return retry
 With the zero point return retry function, the dwell time can be set for reverse run operation started at detection of the upper/lower limit signal and for a machine zero point return executed after a stop by near-point dog OFF when a zero point return retry is made.

"Pr.58 Dwell time during zero point return retry" is made valid when the operation stops in position "A" of the following figure. (The dwell times in positions A and B are the same values.)

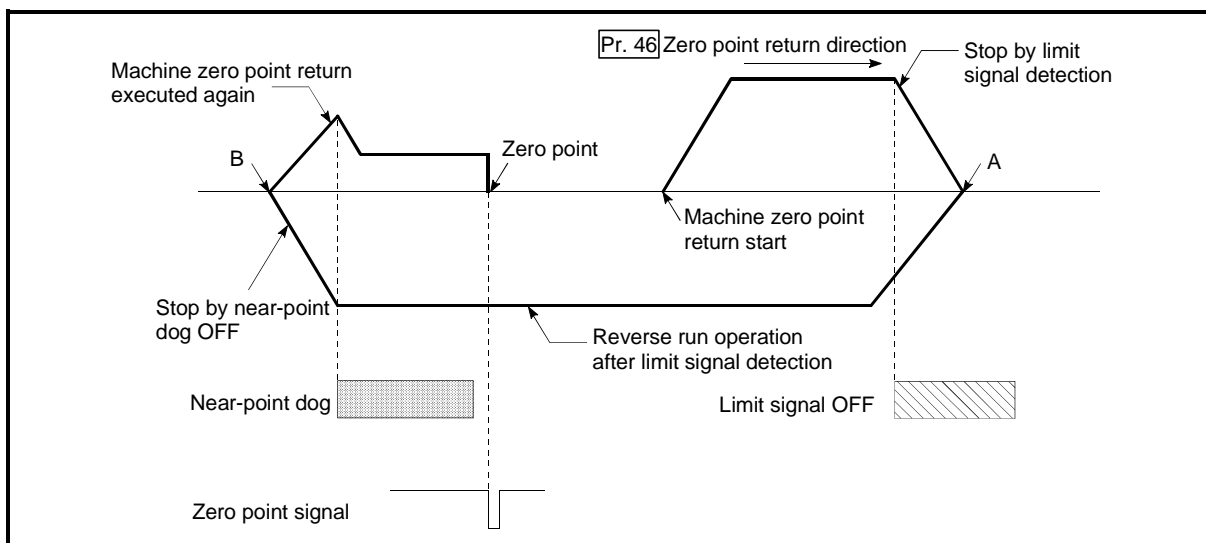

Fig. 12.3 Setting the dwell time during a zero point return retry

(2) Precaution during control

- (a) The following table shows whether the zero point return retry function may be executed by the "[Pr.45] Zero point return method".

[Pr.45] Zero point return method	Execution status of zero point return retry function
Near-point dog method	○ : Execution possible
Stopper stop method 1)	△ : Execution may not be possible due to the stopper
Stopper stop method 2)	△ : Execution may not be possible due to the stopper
Stopper stop method 3)	× : Execution not possible
Count method 1)	○ : Execution possible
Count method 2)	○ : Execution possible

- (b) Always establish upper/lower limit switches at the upper/lower limit positions of the machine, and connect an AD75 module. If the zero point return retry function is used without hardware stroke limit switches, the motor will continue rotation until a hardware stroke limit signal is detected.
- (c) Always wire AD75 upper/lower limit switches even when the zero point return function is invalidated. Control cannot be carried out with the AD75 unless the wiring is carried out.
- (d) Do not carry out settings so that the drive unit power turns OFF by the upper/lower limit switches connected to the AD75. If the drive unit power is turned OFF, the zero point return retry cannot be carried out.

(3) Setting the zero point return retry function

To use the "zero point return retry function", set the required details in the parameters shown in the following table, and write them to the AD75.

When the parameters are set, the zero point return retry function will be added to the machine zero point return control. The set details are validated at the rising edge (OFF → ON) of the PLC READY signal (Y1D). Set "[Pr.58] Dwell time during zero point return retry" according to the user's requirements.

Setting item	Setting value	Setting details	Factory-set initial value
[Pr.50] Zero point return retry	1	Set "1: Carry out zero point return retry by limit switch".	0
[Pr.58] Dwell time during zero point return retry	→	Set the deceleration stop time during zero point return retry. (Random value between 0 and 65535 (ms))	0

* Refer to section "5.2 List of parameters" for setting details.

REMARK

- Parameters are set for each axis.
- It is recommended that the parameters be set whenever possible with the AD75 software package. Execution by sequence program uses many sequence programs and devices. The execution becomes complicated, and the scan times will increase.

12.2.2 Zero point shift function

When a machine zero point return is carried out, the zero point is normally established using the near-point dog, stopper, and zero point signal. However, by using the zero point shift function, the machine can be moved a designated movement amount from the position where the zero point signal was detected. A mechanically established zero point can then be interpreted at that point.

The zero point shift function can be used without relation to "Pr.45 Zero point return method".

The details shown below explain about the "zero point shift function".

- (1) Control details
- (2) Setting range for the zero point shift amount
- (3) Movement speed during zero point shift
- (4) Precautions during control
- (5) Setting the zero point shift function

(1) Control details

The following drawing shows the operation of the zero point shift function.

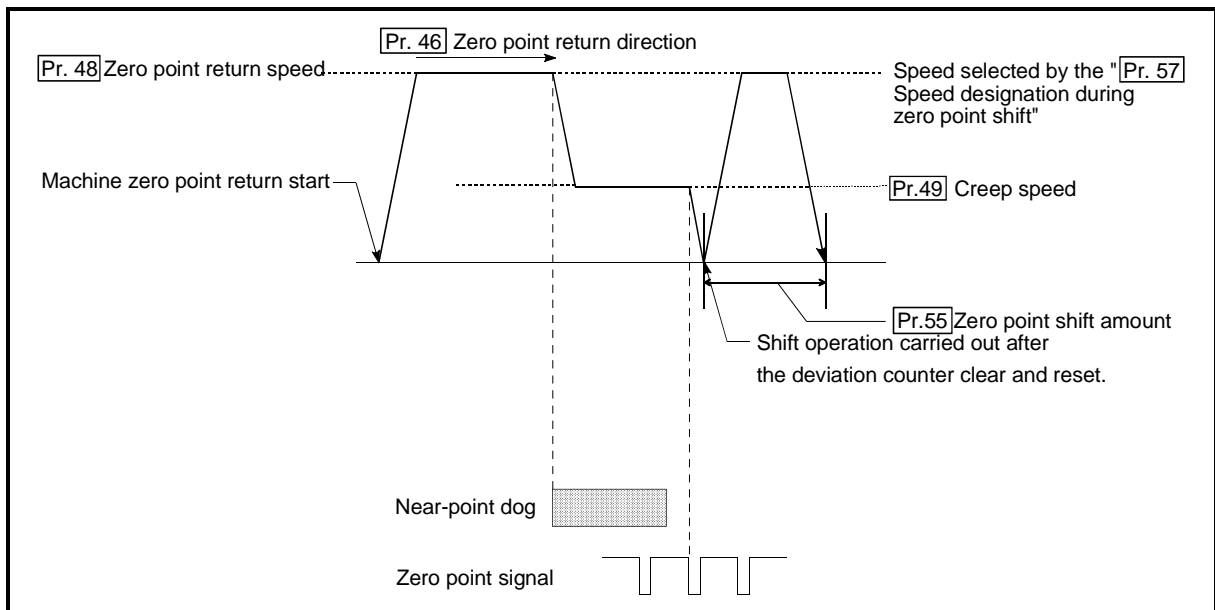

Fig. 12.4 Zero point shift operation

(2) Setting range for the zero point shift amount

Set the zero point shift amount within the range from the detected zero point signal to the upper/lower limit switches.

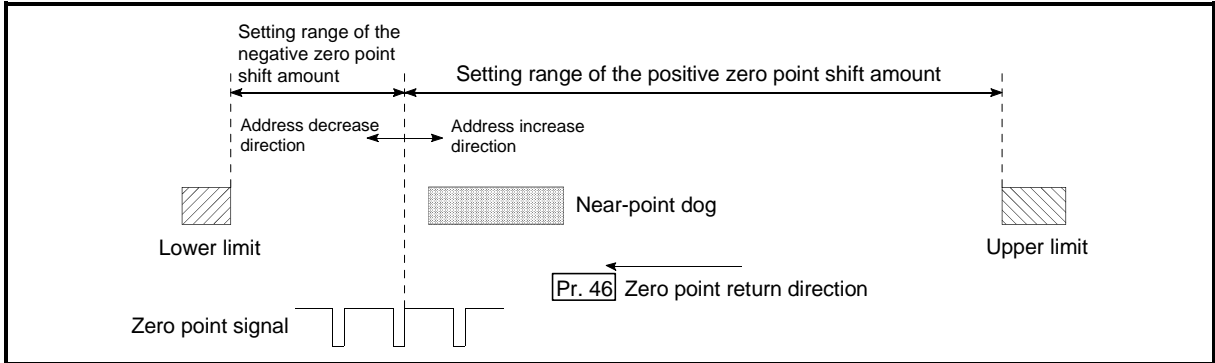

Fig. 12.5 Setting range for the zero point shift amount

(3) Movement speed during zero point shift

When using the zero point shift function, the movement speed during the zero point shift is set in "Pr.57 Speed designation during zero point shift". The movement speed during the zero point shift is selected from either the "Pr.48 Zero point return speed" or the "Pr.49 Creep speed". The following drawings show the movement speed during the zero point shift when a machine zero point return is carried out by the near-point dog method.

(a) Zero point shift operation at the "Pr.48 Zero point return speed"

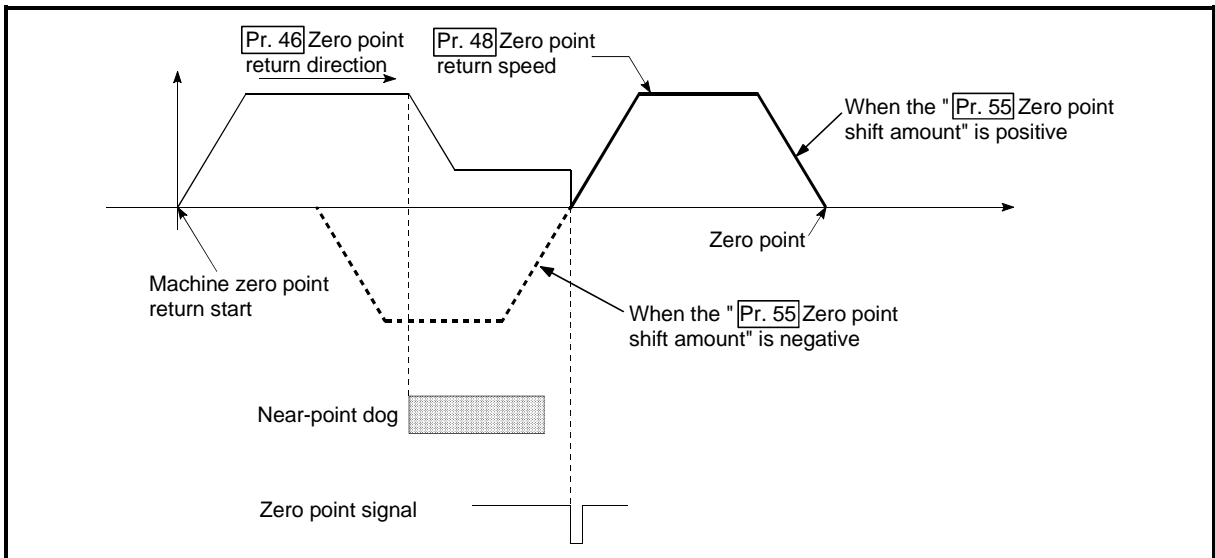

Fig. 12.6 Zero point shift operation at the zero point return speed

(b) Zero point shift operation at the "Pr.49 Creep speed"

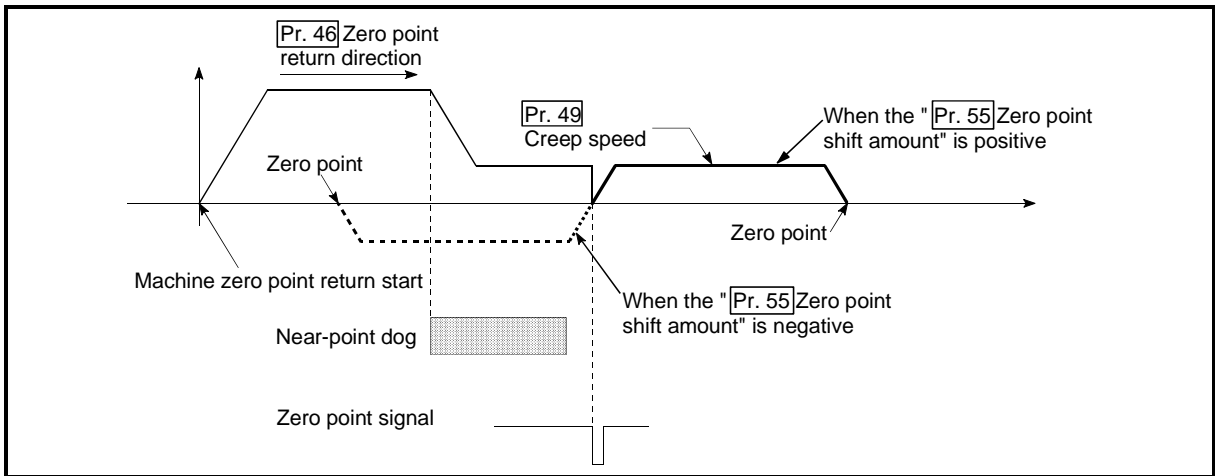

Fig. 12.7 Zero point shift operation at the creep speed

(4) Precautions during control

The following data are set after the zero point shift amount is complete.

- Zero point return request flag (Md.40 Status: b3)
- Zero point return complete flag (Md.40 Status: b4)
- Md.29 Current feed value
- Md.30 Machine feed value
- Md.35 Axis operation status
- Md.44 Movement amount after near-point dog ON ("Pr.55 Zero point shift amount" is not added.)

(5) Setting the zero point shift function

To use the "zero point shift function", set the required details in the parameters shown in the following table, and write them to the AD75.

When the parameters are set, the zero point shift function will be added to the machine zero point return control. The set details are validated at the rising edge (OFF → ON) of the PLC READY signal (Y1D).

Setting item	Setting value	Setting details	Factory-set initial value
Pr.55 Zero point shift amount	→	Set the shift amount during the zero point shift.	0
Pr.57 Speed designation during zero point shift	→	Select the speed during the zero point shift 0: Pr.48 Zero point return speed 1: Pr.49 Creep speed	0

* Refer to "5.2 List of parameters" for setting details.

REMARK

- Parameters are set for each axis.
- It is recommended that the parameters be set whenever possible with the AD75 software package. Execution by sequence program uses many sequence programs and devices. The execution becomes complicated, and the scan times will increase.

12.3 Functions for compensating the control

The auxiliary functions for compensating the control include the "backlash compensation function", "electronic gear function", and "near pass mode function". Each function is executed by parameter setting or sequence program creation and writing.

12.3.1 Backlash compensation function

The "backlash compensation function" compensates the backlash amount in the mechanical system. When the backlash compensation amount is set, an extra amount of pulses equivalent to the set backlash amount is output every time the movement direction changes.

The details shown below explain about the "backlash compensation function".

- (1) Control details
- (2) Precautions during control
- (3) Setting the backlash compensation function

(1) Control details

The following drawing shows the operation of the backlash compensation function.

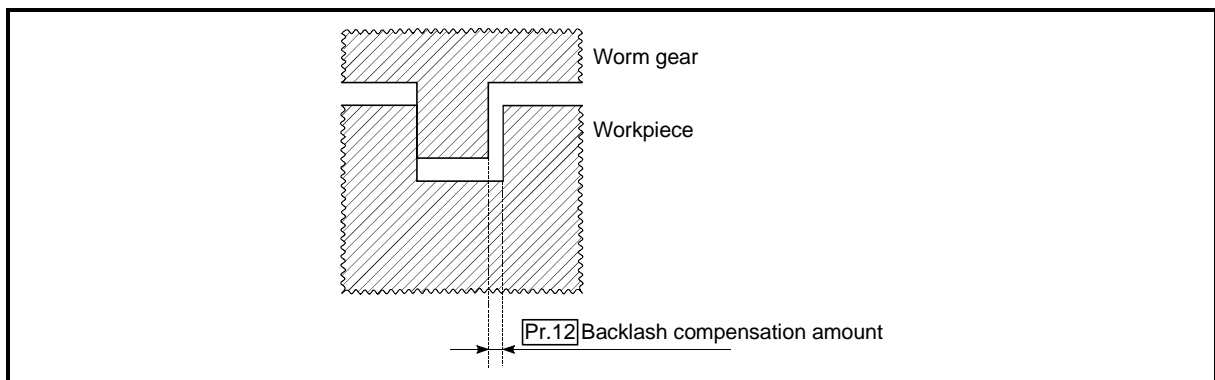

Fig. 12.8 Backlash compensation amount

(2) Precautions during control

- (a) The feed pulses of the backlash compensation amount are not added to the "[Md.29] Current feed value" or "[Md.30] Machine feed value".
- (b) Always carry out a machine zero point return before starting the control when using the backlash compensation function (when "[Pr.12] Backlash compensation amount" is set). The backlash in the mechanical system cannot be correctly compensated if a machine zero point return is not carried out.
- (c) Set the No. of pulses output in one backlash compensation (value in which the "[Pr.12] Backlash compensation amount" is divided by the "movement amount per pulse") to a value of 255 or lower. A "Setting error" will occur if a value over 255 is set. (Depending on the connected servo, tracking may not be possible if a large amount of pulses is output at once.)

$$0 \leq \frac{\text{Backlash compensation amount}}{\text{Movement amount per pulse}} \leq 255$$

(Omit values after the decimal point.)

(3) Setting the backlash compensation function

To use the "backlash compensation function", set the "backlash compensation amount" in the parameter shown in the following table, and write it to the AD75. The set details are validated at the rising edge (OFF → ON) of the PLC READY signal (Y1D).

Setting item	Setting value	Setting details	Factory-set initial value
[Pr.12] Backlash compensation amount	→	Set the backlash compensation amount.	0

* Refer to section "5.2 List of parameters" for setting details.

REMARK

- Parameters are set for each axis.
- It is recommended that the parameters be set whenever possible with the AD75 software package. Execution by sequence program uses many sequence programs and devices. The execution becomes complicated, and the scan times will increase.

12.3.2 Electronic gear function

The "electronic gear function" adjusts the position and speed commands calculated and output according to the parameters set in the AD75 with the actual machine movement amount.

The "electronic gear function" has the following four functions.

- (A) During machine movement, the function increments in the AD75 values less than one pulse that could not be position command output, and outputs the incremented amount of position commands when the total incremented value reached one pulse or more.
- (B) The accumulated value not reaching one pulse is reset to zero when sizing feed control is started. (Even if sizing feed control continues, the same machine movement amount is always used for the control.)
- (C) When the current value is changed, the accumulated value not reaching one pulse is reset to zero.
- (D) The function compensates the mechanical system error of the command movement amount and actual movement amount by adjusting the "movement amount per pulse".
(The "movement amount per pulse" value is defined by "Pr.2 No. of pulses per rotation (Ap)", "Pr.3 Movement amount per rotation (Al)", and "Pr.4 Unit magnification (Am)".)

The AD75 automatically carries out the processing for (A), (B) and (C).

The details shown below explain about the "electronic gear function", including the method for compensating the error in (D) above, etc.

- (1) Error compensation method
- (2) Relation between the movement amount per pulse and speed
- (3) Precautions during control

(1) Error compensation method

When position control is carried out by the "movement amount per pulse" set in the AD75 parameters, an error sometimes occurs between the command movement amount (L) and the actual movement amount (L').

That error is compensated in the AD75 by adjusting the values in "Pr.2 No. of pulses per rotation (Ap)", "Pr.3 Movement amount per rotation (Al)", and "Pr.4 Unit magnification (Am)".

(a) Definition

The "error compensation amount" used to carry out the error compensation is defined as follows.

$$\text{Error compensation amount} = \frac{\text{Actual movement amount (L')}}{\text{Designated movement amount (L)}}$$

The AD75 "movement amount per pulse" is calculated with the following equation.

Movement amount per pulse is "A", Pr.2 No. of pulses per rotation is (Ap), Pr.3 Movement amount per rotation is (Al), and Pr.4 Unit magnification is (Am).

$$A = \frac{Al}{Ap} \times Am$$

(b) Procedure

- 1) Set the "command movement amount (L)", and carry out positioning. (Set the "movement amount per pulse (A)" according to section "5.2 List of parameters".)
- 2) After positioning, measure the "actual movement amount (L)".
- 3) Calculate the "error compensation amount".

$$\text{Error compensation amount} = \frac{L'}{L}$$

- 4) Calculate the post-compensation "Pr.2 No. of pulses per rotation (Ap)", "Pr.3 Movement amount per rotation (Al)", and "Pr.4 Unit magnification (Am)" from the "post-compensation movement amount per pulse (A)".

$$\begin{aligned} A &= A \times \text{Error compensation amount} \\ &= \frac{Al}{Ap} \times Am \times \frac{L'}{L} \\ &= \frac{Al'}{Ap'} \times Am' \end{aligned}$$

(Adjust with Am' so that Al' and Ap' do not exceed the setting range.)

--- Calculation example ---

(Conditions)

Movement amount per pulse : 500 (μm/rev)
 No. of pulses per rotation : 12000 (pulse/rev)
 Unit magnification : 1

(Positioning results)

Command movement amount : 100mm
 Actual movement amount : 101mm

(Compensation amount)

$$\frac{AL'}{AP'} = \frac{5 \times 10^3}{12000} \times \frac{101 \times 10^3}{101 \times 10^3} = \frac{5050}{12000} = \frac{101}{240}$$

Movement amount per pulse : 101 (μm/rev)
 No. of pulses per rotation : 240 (pulse/rev)
 Unit magnification : 1

- 5) Set the post-compensation " No. of pulses per rotation (Ap')", " Movement amount per rotation (Al')", and " Unit magnification (Am')" in the parameters, and write them to the AD75. The set details are validated at the rising edge (OFF → ON) of the PLC READY signal (Y1D).

Setting item		Setting value	Setting details	Pre-compensation value
<input type="text" value="Pr.2"/>	No. of pulses per rotation	Ap'	Set the post-compensation value.	Ap
<input type="text" value="Pr.3"/>	Movement amount per rotation	Al'	Set the post-compensation value.	Al
<input type="text" value="Pr.4"/>	Unit magnification	Am'	Set the post-compensation value.	Am

* Refer to section "5.2 List of parameters" for setting details.

(2) Relation between the movement amount per pulse and speed

The following shows the relation of the "movement amount per pulse (A)" to the command speed and actual speed. The command speed is the speed commanded by each control, and the actual speed is the actual feedrate.

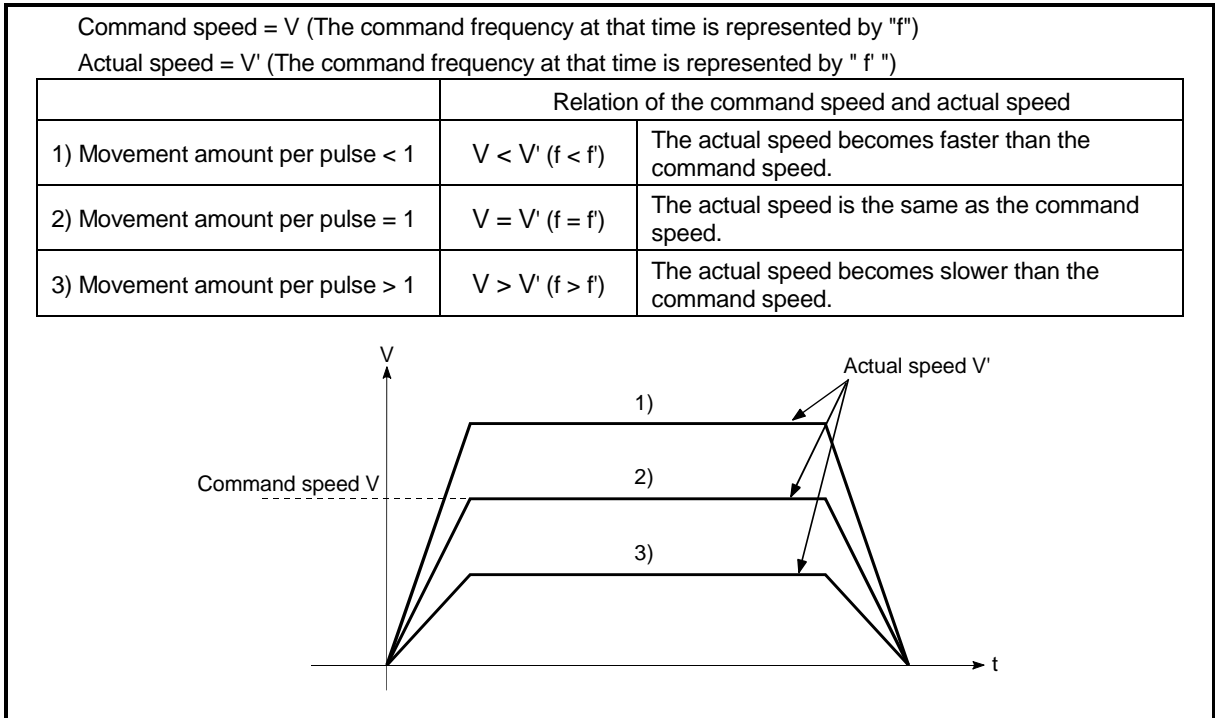

Fig. 12.9 Relation of the movement amount per pulse to the command speed and actual speed

(3) Precautions during control

It is recommended that the "movement amount per pulse (A)" be set to a value close to "1" for the following reasons.

"1" set in the "movement amount per pulse" indicates the minimum value of

"[Pr.1] Unit setting." (In case of [mm] unit: 0.1 [μ m])

"Movement amount per pulse" = "1" means the minimum value of "[Pr.1] Unit setting". (0.1 [(m) when the unit setting is [mm])

- (a) If the setting of the movement amount per pulse is less than 1, the command frequency increases, and the actual speed may exceed the speed limit value ([Pr.7] Speed limit value, [Pr.32] JOG speed limit value), causing the servomotor speed to be overspeed.
- (b) If the setting of the movement amount per pulse is less than 1, the mechanical system may vibrate.
- (c) Set the movement amount per pulse that will make the pulse output frequency to the drive unit not more than 400kpps when the differential driver is connected, or not more than 200kpps when the open collector is connected.
If the setting of the movement amount per pulse is a value that will make the pulse output frequency to the drive unit more than 400kpps (when the differential driver is connected) or more than 200kpps (when the open collector is connected), the AD75 may operate improperly.
- (d) Depending on the servomotor resolution (No. of PLG pulses), the speed may not reach the rated speed, even when the pulses are output from the AD75 at the max. pulse output frequency. In this case, a drive unit electronic gear function, etc., is jointly used.

(Example) No. of pulses per servomotor rotation = 16384 pulses

Rated speed = 2000r/min

AD75 differential driver = 400kpps

In this case, the speed is calculated by the following equation.

$$\frac{400000}{16384} \times 60 = 1465 \text{ (r/min)} < 2000 \text{ (r/min)}$$

REMARK

In the AD75, the general term for the functions in items (a) to (c) above is defined as the "electronic gear function". Refer to the User's Manual for the servomotor for the definition of the "electronic gear" on the servomotor side.

12.3.3 Near pass mode function

When carrying out continuous path control using interpolation control, either the "positioning address pass mode" or the "near pass mode" can be selected by setting the "Pr.44 Near pass mode selection for path control".

The "near pass mode" can be selected as the "near pass mode function" to suppress the mechanical vibration occurring during speed changes when carrying out continuous path control using interpolation control. (Mechanical vibration may occur in continuous path control due to the dropping of the output speed during speed changes.)

(A) Positioning address pass mode (factory-set initial value)

The control is carried out so the machine passes the position set in "Da.5 Positioning address/movement amount" of each positioning data unit being continuously executed.

(B) Near pass mode

The extra movement amount occurring at the end of each positioning data unit being continuously executed is carried over to the next positioning data unit. By not carrying out alignment, the output speed drops are eliminated, and the mechanical vibration occurring during speed changes can be suppressed. Because alignment is not carried out, the operation is controlled on a path that passes near the position set in "Da.5 Positioning address/movement amount".

The details shown below explain about the "near pass mode function".

- (1) Control details
- (2) Precautions during control
- (3) Setting the near pass mode function

REMARK

The "near pass mode function" is added to AD75 software version "F" and subsequent versions.

(1) Control details

The following drawing shows the paths of the "positioning address pass mode" and "near pass mode".

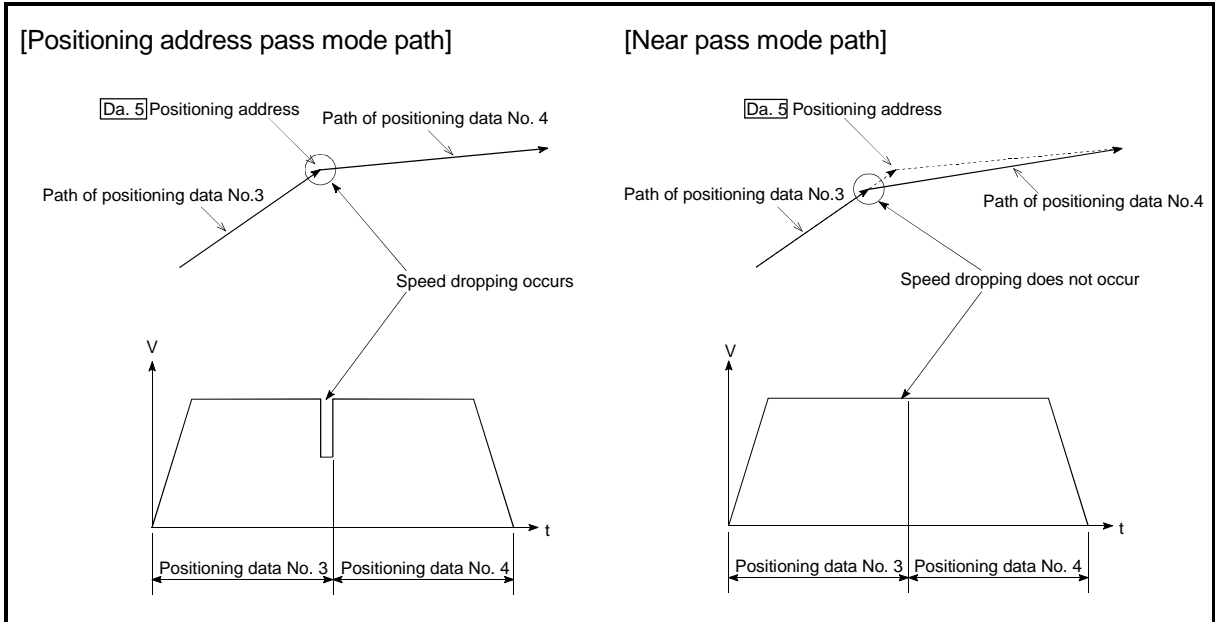

Fig. 12.10 Paths of the positioning address pass mode and near pass mode

(2) Precautions during control

- (a) If the movement amount designated by the positioning data is small when the continuous path control is executed in the near pass mode, the output speed may not reach the designated speed.
- (b) If continuous path control is carried out in the near pass mode, the output will suddenly reverse when the reference axis movement direction changes from the positioning data No. currently being executed to the next positioning data No.
 If the sudden output reversal affects the mechanical system, carry out control with continuous positioning control.
 (When the reference axis movement direction changes in the positioning address pass mode, the operation automatically decelerates.)

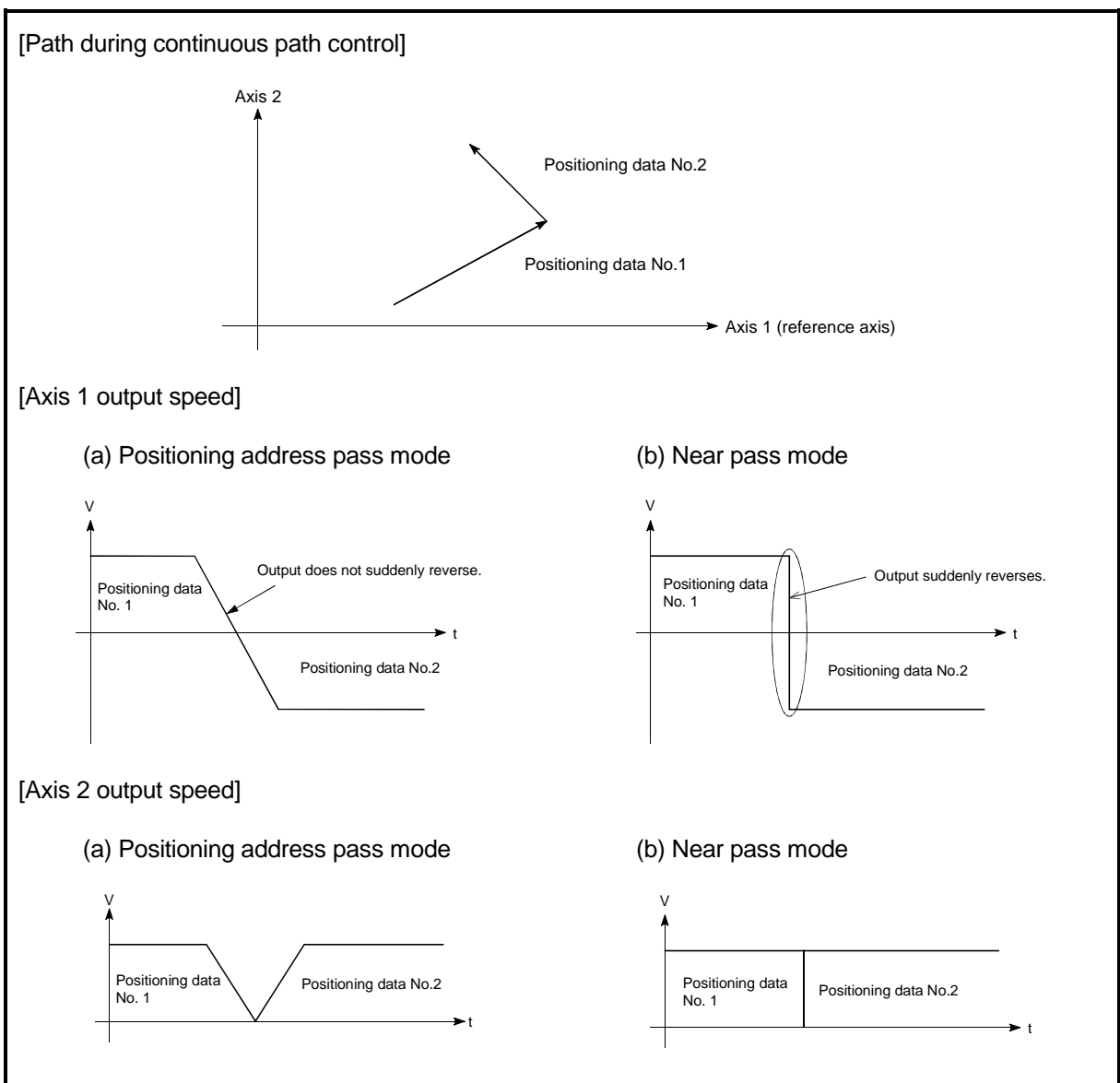

Fig. 12.11 Path and output speed of various axes during continuous path control

- (c) When continuous path control of a circular interpolation is being carried out in the near pass mode, an address in which the extra movement amount is subtracted from the positioning address of the positioning data currently being executed is replaced by the starting point address of the next positioning data No.

Because of this, circular interpolation control cannot be carried out using the increment system.

Because the starting point address will be replaced, an error "large arc error deviation" (error code: 506) may occur.

In this case, adjust the "Pr.42 Allowable circular interpolation error width".

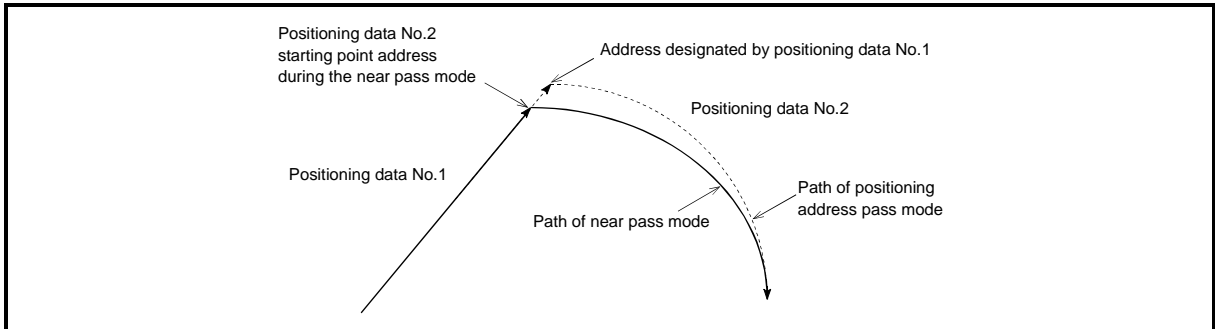
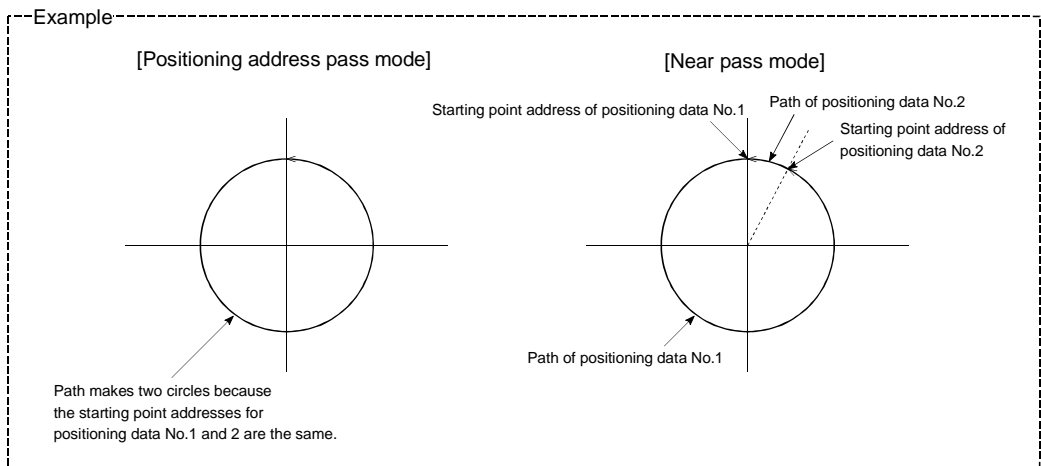

Fig. 12.12 Arc error during the near pass mode

- (d) When a circle center is designated to continuously designate the circular interpolation control by a continuous path designation in the near pass mode, and the positioning address and starting point address of that arc are the same address, the path will make one circle using the two data items. This is because the 2nd data starting point address is shifted by the extra amount of the movement amount occurring from the 1st data.



(3) Setting the near pass mode function

To use the "near path pass mode function", set the "near pass mode" in the parameter shown in the following table, and write it to the AD75.

The set details are validated at the rising edge (OFF → ON) of the PLC READY signal (Y1D).

Setting item	Setting value	Setting details	Factory-set initial value
Pr.44 Near pass mode selection for path control	1	Set "1: Near pass mode".	0: Positioning address pass mode

* Refer to section "5.2 List of parameters" for setting details.

12.4 Functions to limit the control

Functions to limit the control include the "speed limit function", "torque limit function", "software stroke limit", and "hardware stroke limit". Each function is executed by parameter setting or sequence program creation and writing.

12.4.1 Speed limit function

The speed limit function limits the command speed to a value within the "speed limit value" setting range when the command speed during control exceeds the "speed limit value".

The details shown below explain about the "speed limit function".

- (1) Relation between the speed limit function and various controls
- (2) Precautions during control
- (3) Setting the speed limit function

(1) Relation between the speed limit function and various controls

The following table shows the relation of the "speed limit function" and various controls.

Control type		Speed limit function	Speed limit value	
Zero point return control	Machine zero point return control	◎	Pr.7 Speed limit value	
	High-speed zero pint return control	◎		
Main positioning control	Position control	1-axis linear control		◎
		2-axis linear interpolation control		◎
		1-axis fixed-dimension feed control		◎
		2-axis fixed-dimension feed control (interpolation)		◎
		2-axis circular interpolation control		◎
		Speed control		◎
	Speed/position changeover control	◎		
	Other control	Current value change		—
JUMP command		—		
Manual control	JOG operation	◎	Pr.32 JOG speed limit value	
	Manual pulse generator operation	×	Setting not possible.	

◎ : Always set

× : Setting not possible

— : Setting not required (Setting value is invalid. Use the initial values or setting values within a range where no error occurs.)

(2) Precautions during control

During interpolation control, speed limiting is carried out at the reference axis side setting value.

(The speed limit will not function on the interpolation side.)

(3) Setting the speed limit function

To use the "speed limit function", set the "speed limit value" in the parameters shown in the following table, and write them to the AD75.

The set details are validated after they are written to the AD75.

Setting item	Setting value	Setting details	Factory-set initial value
Pr.7 Speed limit value	→	Set the speed limit value (max. speed during control).	0
Pr.32 JOG speed limit value	→	Set the speed limit value during JOG operation (max. speed during control). (Note that " Pr.32 JOG speed limit value" shall be less than or equal to " Pr.7 Speed limit value".)	0

* Refer to section "5.2 List of parameters" for setting details.

REMARK

- Parameters are set for each axis.
- It is recommended that the parameters be set whenever possible with the AD75 software package. Execution by sequence program uses many sequence programs and devices. The execution becomes complicated, and the scan times will increase.

12.4.2 Torque limit function

The "torque limit function" limits the generated torque to a value within the "torque limit value" setting range when the torque generated in the servomotor exceeds the "torque limit value".

The "torque limit function" protects the deceleration function, limits the power of the operation pressing against the stopper, etc. It controls the operation so that unnecessary force is not applied to the load and machine.

The details shown below explain about the "torque limit function".

- (1) Relation between the torque limit function and various controls
- (2) Control details
- (3) Precautions during control
- (4) Setting the torque limit function

(1) Relation between the torque limit function and various controls

The following table shows the relation of the "torque limit function" and various controls.

Control type		Torque limit function	Torque limit value *	
Zero point return control	Machine zero point return control	○	[Pr.18] Torque limit setting value * After the "[Pr.49] Creep speed" is reached, this value becomes the "[Pr.56] Zero point return torque limit value".	
	High-speed zero pint return control	○		
Main positioning control	Position control	1-axis linear control		○
		2-axis linear interpolation control		○
		1-axis fixed-dimension feed control		○
		2-axis fixed-dimension feed control (interpolation)		○
		2-axis circular interpolation control		○
	Speed control	○		
	Speed/position changeover control	○		
Other control	Current value change	-		Setting value is invalid.
	JUMP command	-		
Manual control	JOG operation	○	[Pr.18] Torque limit setting value	
	Manual pulse generator operation	○	[Pr.18] Torque limit setting value	

- : Set when required (Set to " - " when not used.)
- : Setting not required (Setting value is invalid. Use the initial values or setting values within a range where no error occurs.)
- * : Shows the torque limit value when "[Cd.30] New torque value" is set to "0".

(2) Control details

The following drawing shows the operation of the torque limit function.

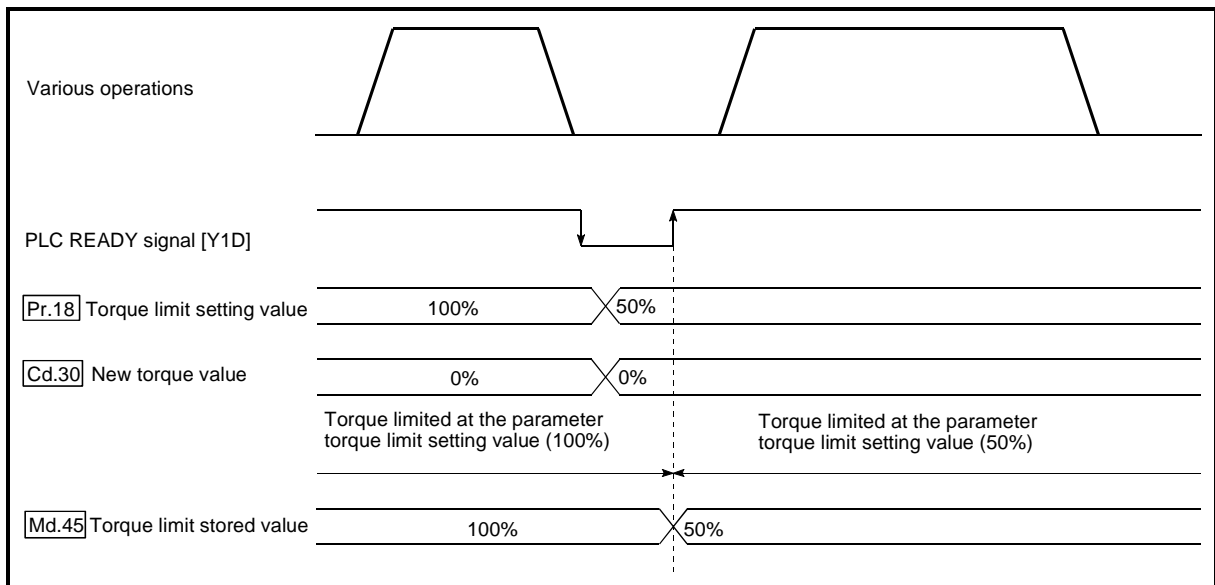

Fig. 12.13 Torque limit function operation

(3) Precautions during control

- (a) When limiting the torque at the "[Pr.18] Torque limit setting value", confirm that "[Cd.30] New torque value" is set to "0". If this parameter is set to a value besides "0", the "[Cd.30] New torque value" will be validated, and the torque will be limited at that value. (Refer to section "12.5.4 Torque change function" for details about the "new torque value".)
- (b) When limiting the torque, a D/A converter module and drive unit in which torque limit commands by analog voltage are possible.
- (c) When the operation is stopped by torque limiting, the droop pulse will remain in the deviation counter. If a "deviation counter clear" is carried out by issuing an external signal at this time, positional deviation will occur when the operation is continued. If the load torque is eliminated, operation for the amount of droop pulses will be carried out.

(4) Setting the torque limit function

- (a) To use the "torque limit function", set the "torque limit value" in the parameters shown in the following table, and write them to the AD75. The set details are validated at the rising edge (OFF → ON) of the PLC READY signal (Y1D).

Setting item	Setting value	Setting details	Factory-set initial value
Pr.18 Torque limit setting value	→	Set the torque limit value as a percentage.	300
Pr.56 Zero point return torque limit value	→	Set the torque limit value after the "Pr.49 Creep speed" is reached. Set as a percentage.	300

* Refer to section "5.2 List of parameters" for setting details.

- (b) The "torque limit value" set in the AD75 is set in the "Md.45 Torque limit stored value". The "Md.45 Torque limit stored value" in the sequence program is transferred to the "D/A converter module", and the torque is limited.

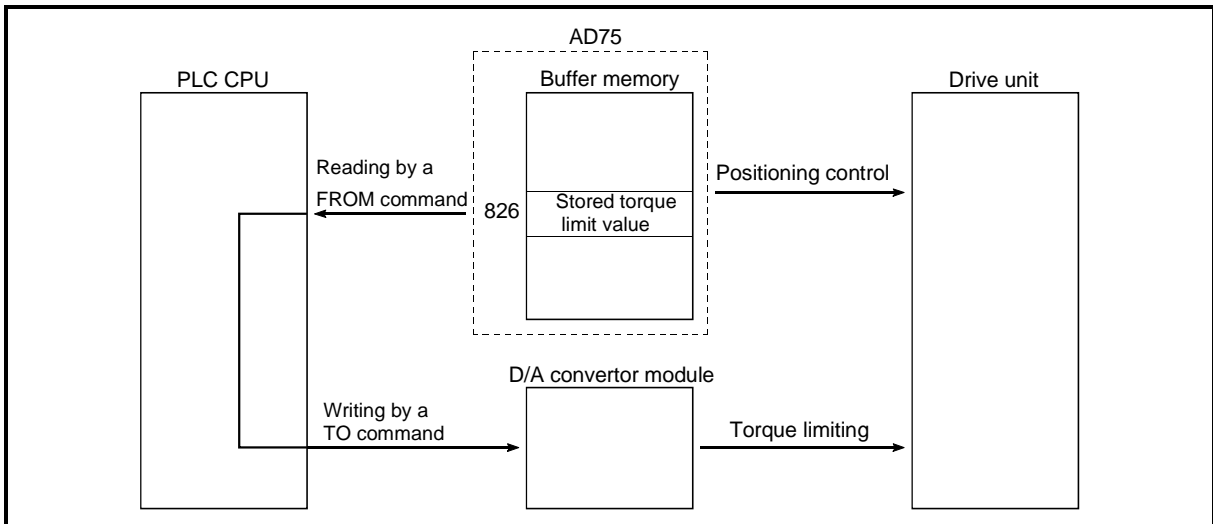

Fig. 12.14 Limiting the torque to the drive unit

The following table shows the "Md.45 Torque limit stored value" of the buffer memory address.

Monitor item	Monitor value	Storage details	Buffer memory address		
			Axis 1	Axis 2	Axis 3
Md.45 Torque limit stored value	→	The "torque limit value" valid at that time is stored. (Pr.18, Pr.56, or Cd.30)	826	926	1026

* Refer to section "5.6 List of monitor data" for information on the setting details.

REMARK

- Parameters are set for each axis.
- It is recommended that the parameters be set whenever possible with the AD75 software package. Execution by sequence program uses many sequence programs and devices. The execution becomes complicated, and the scan times will increase.

12.4.3 Software stroke limit function

In the "software stroke limit function" the address established by a machine zero point return is used to set the upper and lower limits of the moveable range of the workpiece. Movement commands issued to addresses outside that setting range will not be executed.

In the AD75, the "current feed value" and "machine feed value" are used as the addresses indicating the current position. However, in the "software stroke limit function", the address used to carry out the limit check is designated in the "Pr.15 Software stroke limit selection". (Refer to section "9.1.4 Confirming the current value" or details on the "current feed value" and "machine feed value".)

The upper and lower limits of the moveable range of the workpiece are set in "Pr.13 Software stroke limit upper limit value"/ "Pr.14 Software stroke limit lower limit value".

The details shown below explain about the "software stroke limit function".

- (1) Differences in the moveable range when "current feed value" and "machine feed value" are selected.
- (2) Software stroke limit check details
- (3) Relation between the software stroke limit function and various controls
- (4) Precautions during software stroke limit check
- (5) Setting the software stroke limit function
- (6) Invalidating the software stroke limit
- (7) Setting when the control unit is "degree"

- (1) Differences in the moveable range when "current feed value" and "machine feed value" are selected.

The following drawing shows the moveable range of the workpiece when the software stroke limit function is used.

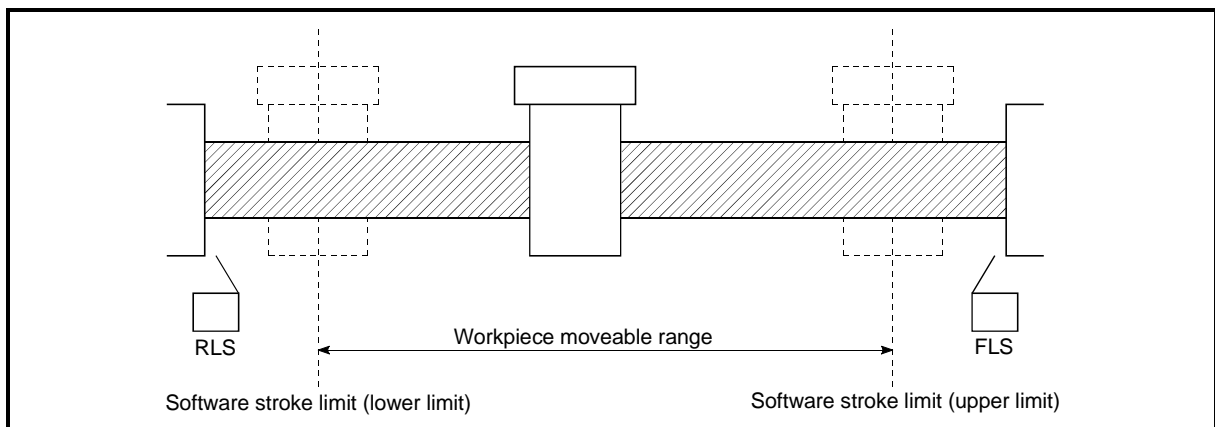

Fig. 12.15 Workpiece moveable range

The following drawing shows the differences in the operation when "[Md.29] Current feed value" and "[Md.30] Machine feed value" are used in the moveable range limit check.

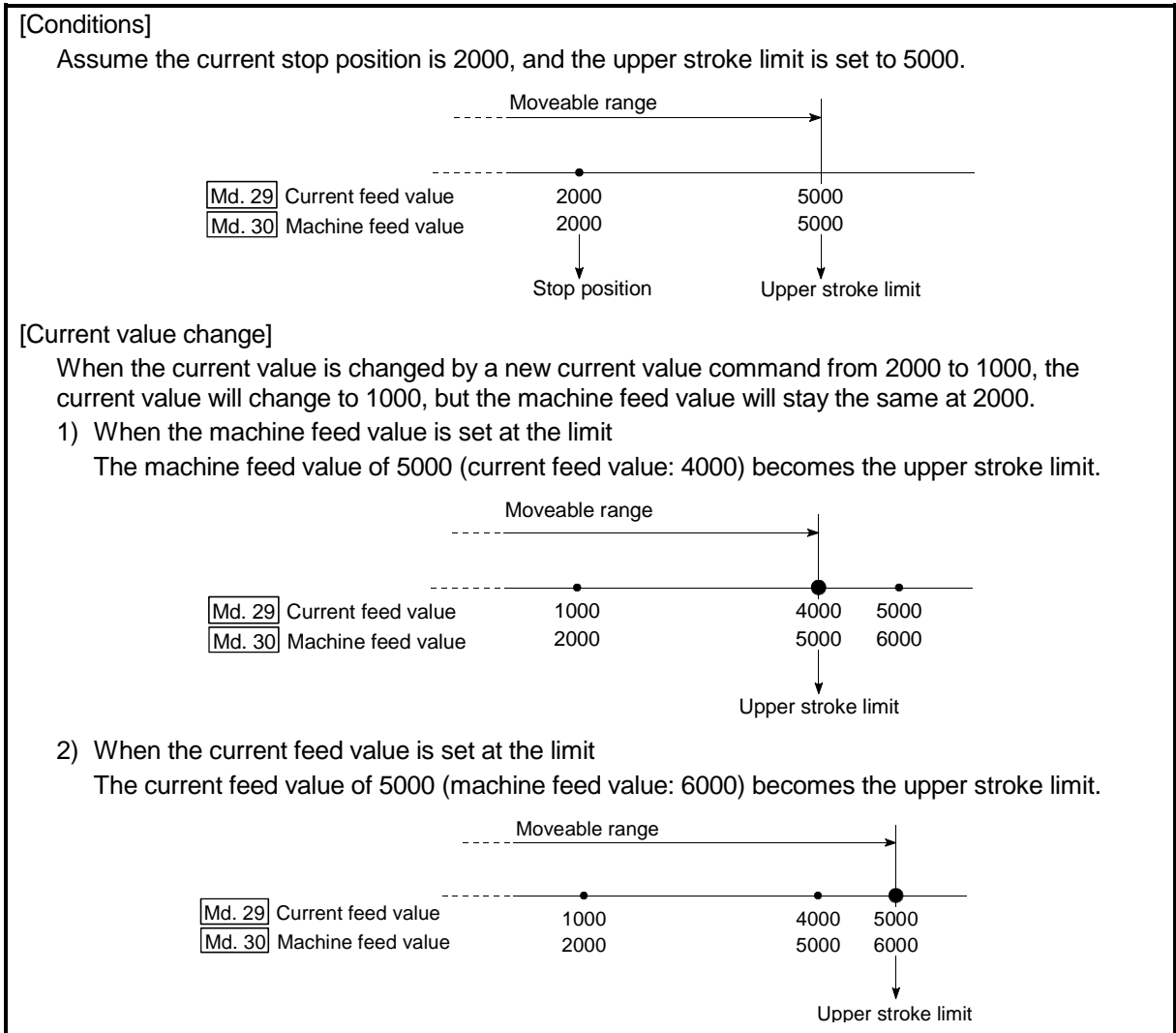

Fig. 12.16 Software stroke limits of the current feed value and machine feed value

POINT
When "machine feed value" is set in "[Pr.15] Software stroke limit selection", the moveable range becomes an absolute range referenced on the zero point. When "current feed value" is set, the moveable range is the relative range from the "current feed value".

(2) Software stroke limit check details

Check details		Processing when an error occurs
1)	An error shall occur if the current value*1 is outside the software stroke limit range*2. (Check "[Md.29] Current feed value" or "[Md.30] Machine feed value".)	An "axis error" will occur, and the operation will not start.
2)	An error shall occur if the command address is outside the software stroke limit range. (Check "[Da.5] Positioning address/movement amount".)	

*1 Check whether the "[Md.29] Current feed value" or "[Md.30] Machine feed value" is set in "[Pr.15] Software stroke limit selection".

*2 Moveable range from the "[Pr.13] Software stroke limit upper limit value" to the "[Pr.14] Software stroke limit lower limit value".

(3) Relation between the software stroke limit function and various controls

Control type		Limit check	Processing at check
Zero point return control	Machine zero point return control	—	Check not carried out.
	High-speed zero pint return control	—	
Main positioning control	Position control	1-axis linear control	Checks 1) and 2) in the previous section (2) are carried out. For position control: The axis comes to an immediate stop when it exceeds the software stroke limit range.
		2-axis linear interpolation control	
		1-axis fixed-dimension feed control	
		2-axis fixed-dimension feed control (interpolation)	
		2-axis circular interpolation control	
	Speed control	○*3, 4	
	Speed/position changeover control	○*3, 4	
Other control	Current value change	—	When the current value is changed, an error will not occur even if the new address is outside the software stroke limit range. However, an error "start outside stroke limit +/-" (error code: 507/508) will occur at the next operation start.
	JUMP command	—	Check not carried out.
Manual control	JOG operation	△*5	Check 1) in the previous section (2) is carried out. The machine will carry out a deceleration stop when the software stroke limit range is exceeded. If the address is outside the software stroke limit range, the operation can only be started toward the moveable range after the error is reset.
	Manual pulse generator operation	△*5	

◎ : Check valid

○ : Check only carried out at start. (If "current feed value" is set in the "[Pr.15] Software stroke limit selection", the check will not be carried out when the "[Pr.22] Current feed value" is updated.)

— : Check not carried out (check invalid).

△ : Valid only when "valid" is set in the "[Pr.16] Software stroke limit valid/invalid setting".

*3 : The value in "[Md.29] Current feed value" will differ according to the "[Pr.22] Current feed value during speed control" setting.

*4 : When the unit is "degree", check is not carried out during speed control.

*5 : When the unit is "degree", check is not carried out.

(4) Precautions during software stroke limit check

- (a) A machine zero point return must be executed beforehand for the "software stroke limit function" to function properly.
- (b) During interpolation control, a stroke limit check is carried out for the current values of both the reference axis and the interpolation axis. Neither axis will start if an error occurs, even if it only occurs in one axis.
- (c) During circular interpolation control, the "Pr.13 Software stroke limit upper limit value"/"Pr.14 Software stroke limit lower limit value" may be exceeded.

In this case, a deceleration stop will not be carried out even if the stroke limit is exceeded. Always install an external limit switch if there is a possibility the stroke limit will be exceeded.

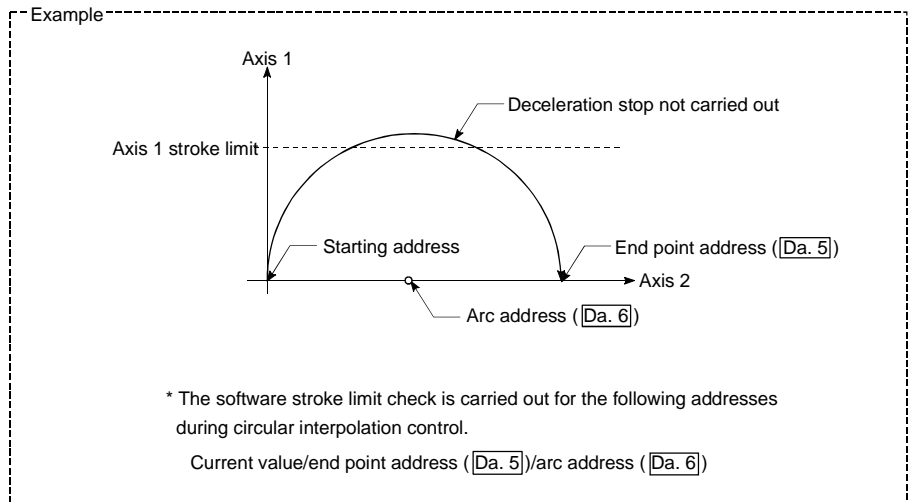

- (d) If an error is detected during continuous path control, the operation will immediately stop after the positioning data just before the positioning data where the error occurred has been executed.

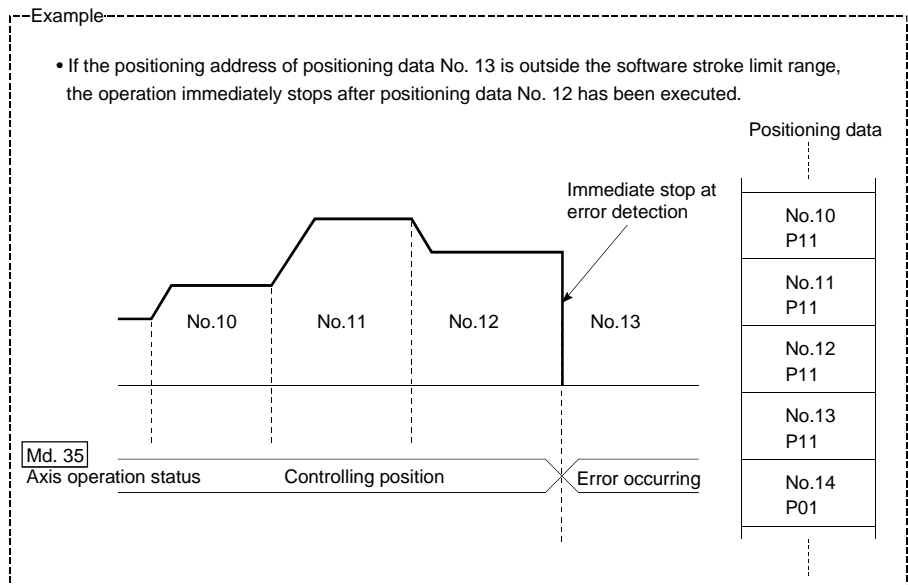

- (e) During simultaneous start, a stroke limit check is carried out for the current values of both axes to be started. Neither axis will start if an error occurs, even if it only occurs in one axis.

(5) Setting the software stroke limit function

To use the "software stroke limit function", set the required values in the parameters shown in the following table, and write them to the AD75.

The set details are validated at the rising edge (OFF → ON) of the PLC READY signal (Y1D).

Setting item	Setting value	Setting details	Factory-set initial value
Pr.13 Software stroke limit upper limit value	→	Set the upper limit value of the moveable range.	2147483647
Pr.14 Software stroke limit lower limit value	→	Set the lower limit value of the moveable range.	-2147483648
Pr.15 Software stroke limit selection	→	Set whether to use the " Md.29 Current feed value" or " Md.30 Machine feed value" as the "current value".	0: Current feed value
Pr.16 Software stroke limit valid/invalid setting	1: Valid	Set whether the software stroke limit is validated or invalidated during manual control (JOG operation, manual pulse generator operation).	0: Invalid

* Refer to section "5.2 List of parameters" for setting details.

(6) Invalidating the software stroke limit

To invalidate the software stroke limit, set the following parameters as shown, and write them to the AD75.

Pr.13 Software stroke limit upper limit value	=	Pr.14 Software stroke limit lower limit value
--	---	--

(For manual operation, set "0: software stroke limit invalid" in the "**Pr.16** Software stroke limit valid/invalid setting".)

The set details are validated at the rising edge (OFF → ON) of the PLC READY signal (Y1D).

When the unit is "degree", the software stroke limit check is not performed during speed control (including speed control in speed/position changeover control) or during manual control, independently of the values set in **Pr.13**, **Pr.14** and **Pr.16**.

REMARK

- Parameters are set for each axis.
- It is recommended that the parameters be set whenever possible with the AD75 software package. Execution by sequence program uses many sequence programs and devices. The execution becomes complicated, and the scan times will increase.

(7) Setting when the control unit is "degree"

■ Current value address

The "[Md.29] Current feed value" address is ring addresses between 0 and 359.99999° .

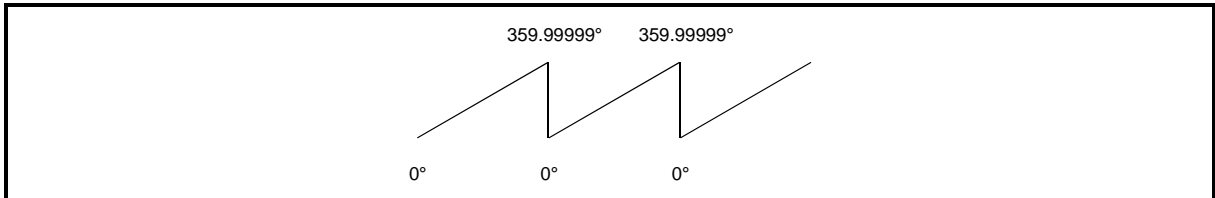

Fig. 12.17 Current value address when the control unit is "degree".

■ Setting the software stroke limit

The upper limit value/lower limit value of the software stroke limit is a value between 0 and 359.99999° .

(1) Setting when the software stroke limit is to be validated.

When the software stroke limit is to be validated, set the upper limit value in a clockwise direction from the lower limit value.

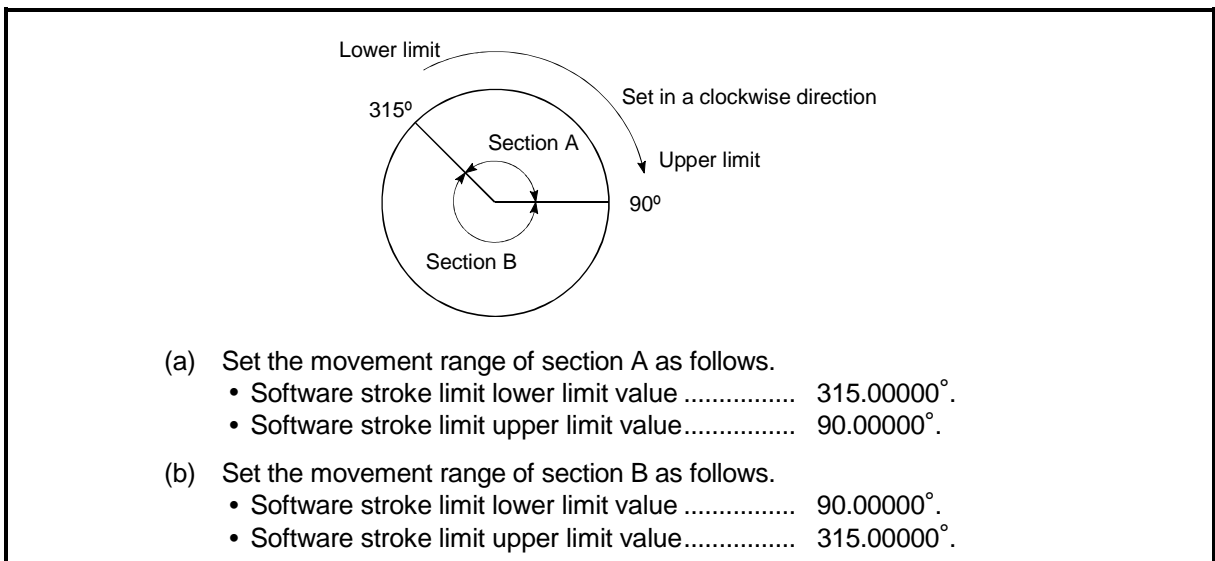

Fig. 12.18 Software stroke limit when the control unit is "degree"

12.4.4 Hardware stroke limit function

In the "hardware stroke limit function", limit switches are set at the upper/lower limit of the physical moveable range, and the control is stopped (by deceleration stop) by the input of a signal from the limit switch. Damage to the machine can be prevented by stopping the control before the upper/lower limit of the physical moveable range is reached.

Hardware stroke limit switches are normally installed inside the stroke limit/stroke end on the drive unit side, and the control is stopped before the stroke limit/stroke end on the drive unit side is reached.

The details shown below explain about the "hardware stroke limit function".

- (1) Control details
- (2) Wiring the hardware stroke limit
- (3) Precautions during control
- (4) When the hardware stroke limit is not used

(1) Control details

The following drawing shows the operation of the hardware stroke limit function.

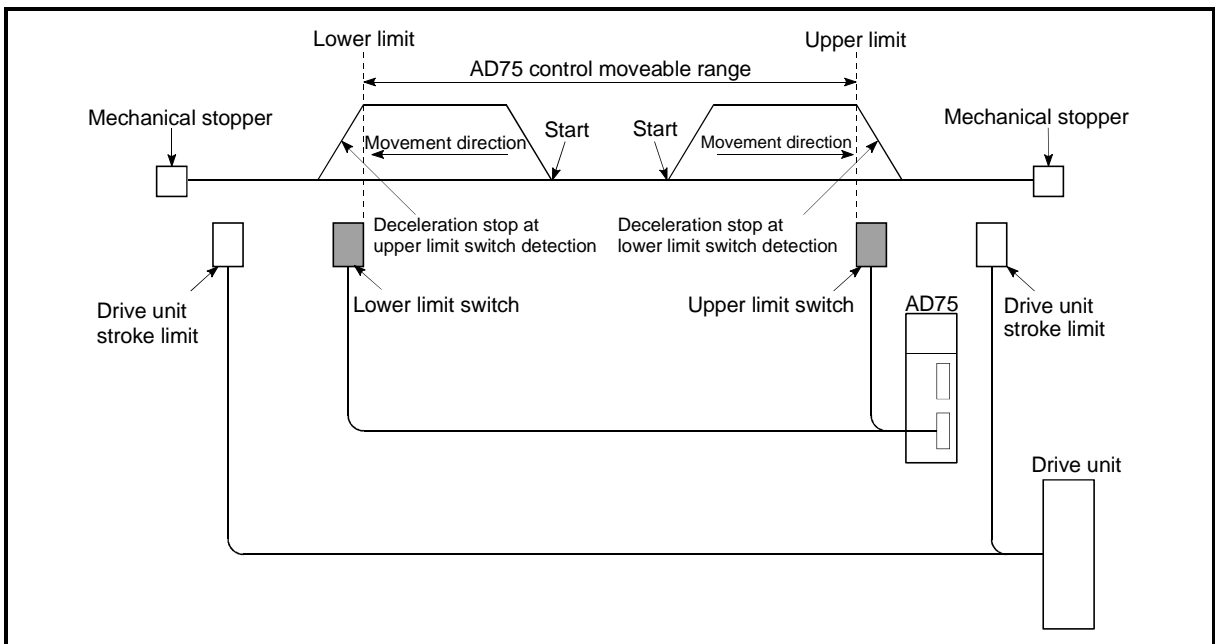

Fig. 12.19 Hardware stroke limit function operation

(2) Wiring the hardware stroke limit

When using the hardware stroke limit function, wire the terminals of the AD75 upper/lower limit stroke limit as shown in the following drawing.

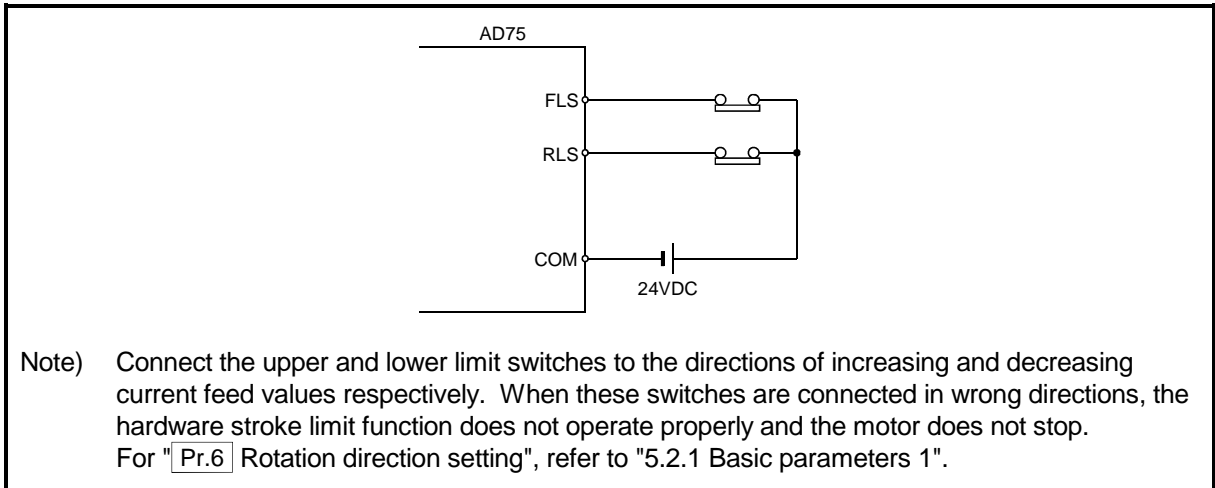

Fig. 12.20 Wiring when using the hardware stroke limit

(3) Precautions during control

- (a) If the machine is stopped outside the AD75 control range (outside the upper/lower limit switches), or if stopped by hardware stroke limit detection, the "zero point return control", "main positioning control", and "advanced positioning control" cannot start. To carry out these types of control again, return the workpiece to the AD75 control range by a "JOG operation" or "manual pulse generator operation".
- (b) If the circuit between the RLS (lower limit signal) and COM, or between the FLS (upper limit signal) and COM is open (including when not wired), the upper/lower limit signals will turn OFF, and control with the AD75 will not be possible.

(4) When the hardware stroke limit is not used

When not using the hardware stroke limit function, wire the terminals of the AD75 upper/lower limit stroke limit as shown in the following drawing.

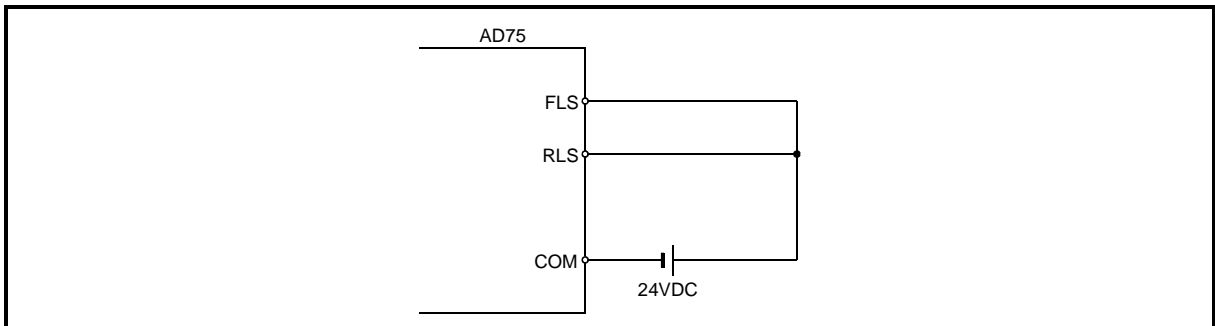

Fig. 12.21 Wiring when not using the hardware stroke limit

12.5 Functions to change the control details

Functions to change the control details include the "speed change function", "override function", "acceleration/deceleration time change function" and "torque change function". Each function is executed by parameter setting or sequence program creation and writing.

Both the "speed change function" or "override function" change the speed, but the differences between the functions are shown below. Use the function that corresponds to the application.

"Speed change function"

- The speed is changed at any time, only in the control being executed.
- The new speed is directly set.

"Override function"

- The speed is changed for all control to be executed. (Note that this excludes manual pulse generator operation.)
- The new speed is set as a percent (%) of the command speed.

12.5.1 Speed change function

The speed control function is used to change the speed during control to a newly designated speed at any time.

The new speed is directly set in the buffer memory, and the speed is changed by a speed change command ($\overline{\text{Cd.17}}$ Speed change request) or external start signal.

The details shown below explain about the "speed change function".

- (1) Control details
- (2) Precautions during control
- (3) Setting the speed change function from the PLC CPU
- (4) Setting the speed change function using an external start signal

(1) Control details

The following drawing shows the operation during a speed change.

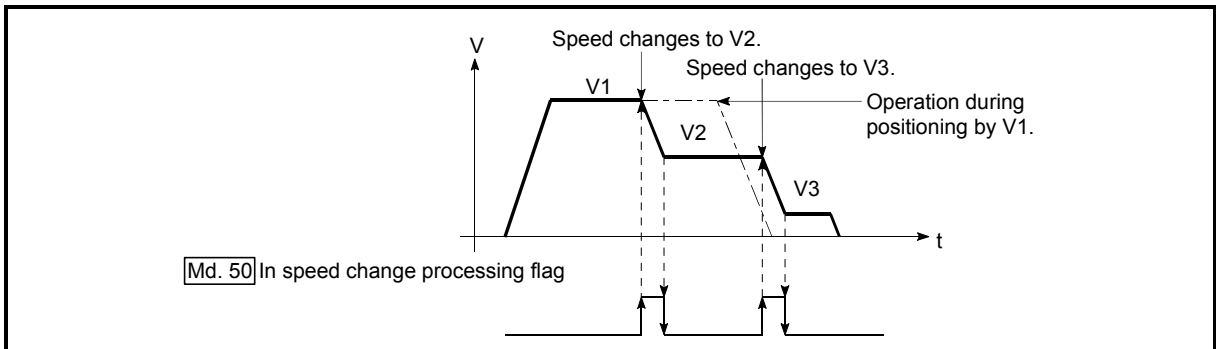

Fig. 12.22 Speed change operation

(2) Precautions during control

(a) Control is carried out as follows at the speed change during continuous path control.

- 1) When no speed designation (current speed) is provided in the next positioning data:
 - The next positioning data is controlled at the "Cd.16 New speed value".
- 2) When a speed designation (current speed) is provided in the next positioning data:
 - The next positioning data is controlled at its command speed (Da.7).

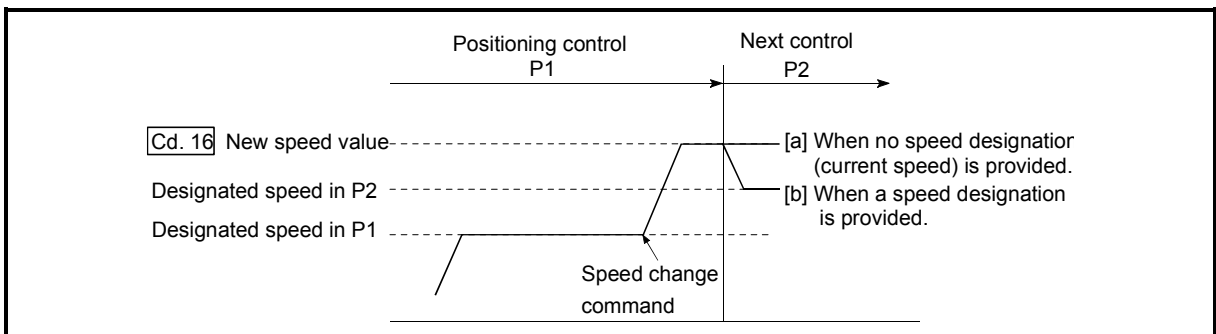

Fig. 12.23 Speed change during continuous path control

(b) When changing the speed during continuous path control, the speed change will be ignored if there is not enough distance remaining to carry out the change.

- (c) When the speed is changed by setting "[Cd.16] New speed value" to "0", the operation is carried out as follows.
- A deceleration stop is carried out, and the speed change 0 flag ([Md.40] Status: b10) turns ON.
(During interpolation control, the speed change 0 flag on the reference axis side turns ON.)
 - The axis stops, but "[Md.35] Axis operation status" does not change, and the BUSY signal remains ON. (If a stop signal is input, the BUSY signal will turn OFF, and "[Md.35] Axis operation status" will change to "stopped".)
- * In this case, setting the "[Cd.16] New speed value" to a value besides "0" will turn OFF the speed change 0 flag ([Md.40] Status: b10), and enable continued operation.

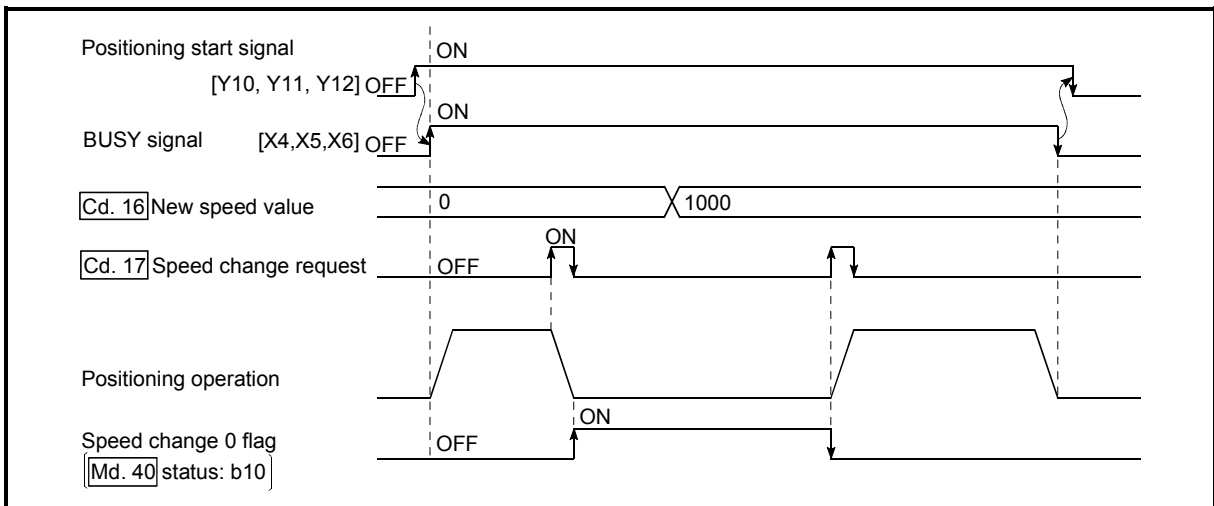

Fig. 12.24 Speed change at new speed value "0"

- (d) A warning "deceleration and stop speed change" (warning code: 500) occurs and the speed cannot be changed in the following cases.
- During deceleration by a stop command
 - During automatic deceleration during positioning control
- (e) A warning "speed limit value over" (warning code: 501) occurs and the speed is controlled at the "[Pr.7] Speed limit value" when the value set in "[Cd.16] New speed value" is equal to or larger than the "[Pr.7] Speed limit value".
- (f) When the speed is changed during interpolation control, the required speed is set in the reference axis.
- (g) When carrying out consecutive speed changes, be sure there is an interval between the speed changes of 100ms or more.
(If the interval between speed changes is short, the AD75 will not be able to track, and it may become impossible to carry out commands correctly.)

(3) Setting the speed change function from the PLC CPU

The following shows the data settings and sequence program example for changing the control speed of axis 1 from the PLC CPU. (In this example, the control speed is changed to "20.00mm/min".)

(a) Set the following data.

(Use the start time chart shown in section (2) below as a reference, and set using the sequence program shown in section (3).)

Setting item	Setting value	Setting details	Buffer memory address		
			Axis 1	Axis 2	Axis 3
Cd.16 New speed value	2000	Set the new speed.	1156	1206	1256
			1157	1207	1257
Cd.17 Speed change request	1	Set "1: Change the speed".	1158	1208	1258

* Refer to section "5.7 List of control data" for details on the setting details.

(b) The following shows the speed change time chart.

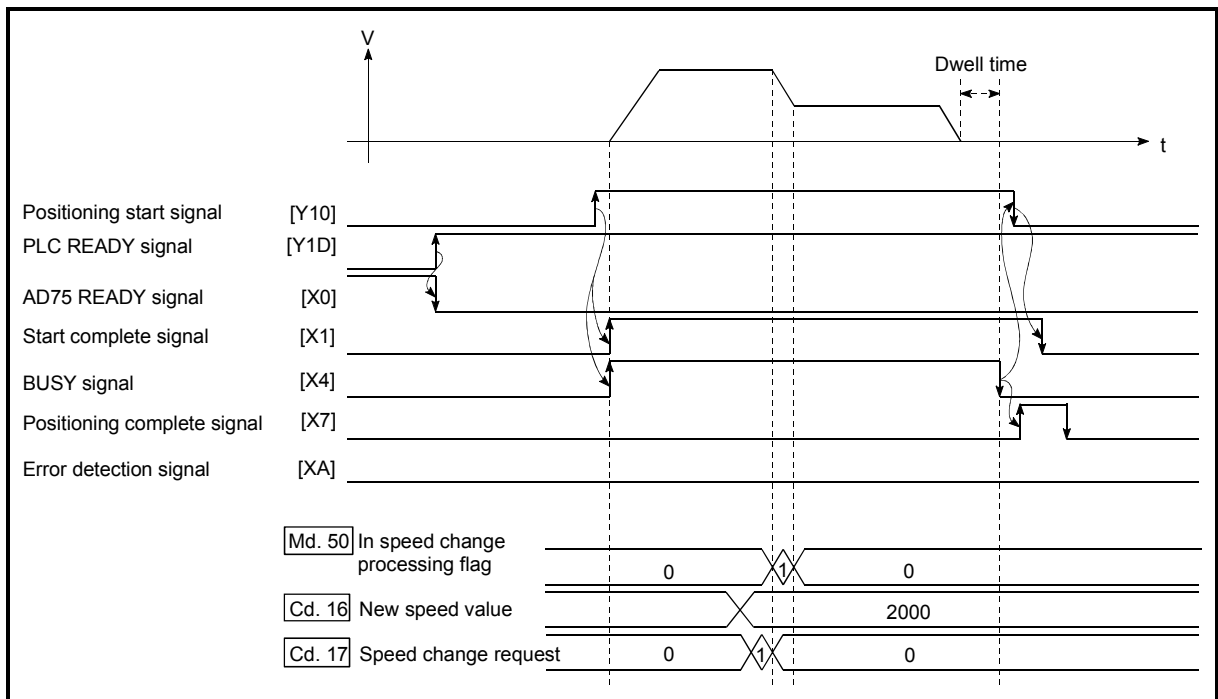
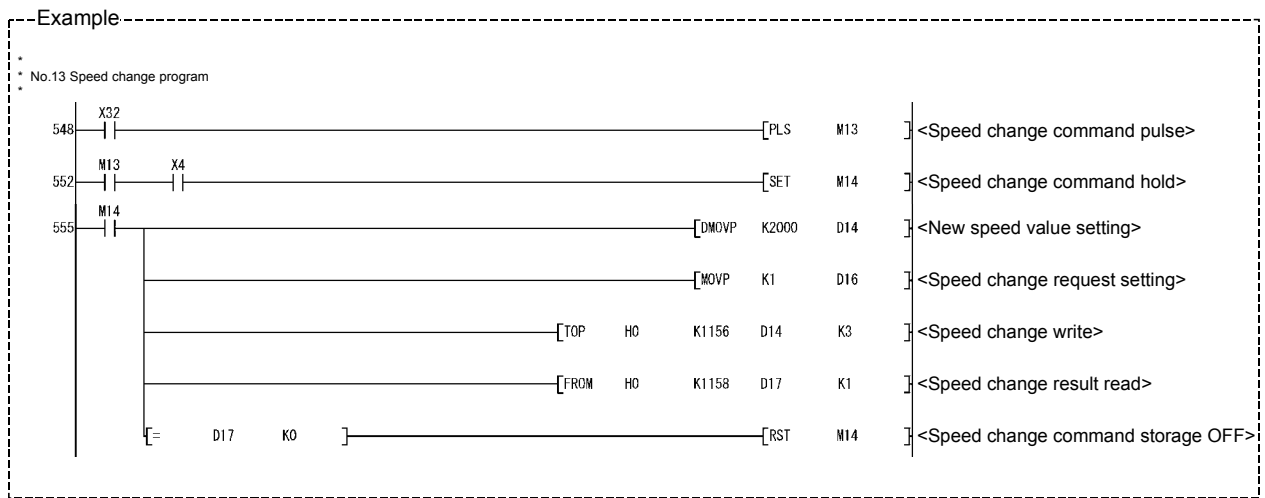

Fig. 12.25 Time chart for changing the speed from the PLC CPU

(c) Add the following sequence program to the control program, and write it to the PLC CPU.



(4) Setting the speed change function using an external start signal

The speed can also be changed using an "external start signal".

The following shows the data settings and sequence program example for changing the control speed of axis 1 using an "external start signal". (In this example, the control speed is changed to "10000.00mm/min".)

- (a) Set the following data to change the speed using an external start signal. (Use the start time chart shown in section (2) below as a reference, and set using the sequence program shown in section (3).)

Setting item	Setting value	Setting details	Buffer memory address		
			Axis 1	Axis 2	Axis 3
Pr.43 External start function selection	1	Set "1: External speed change request".	62	212	362
Cd.16 New speed value	1000000	Set the new speed.	1156	1206	1256
			1157	1207	1257
Cd.25 External start valid	1	Set "1: Validate the external start".	1171	1221	1271

* Refer to section "5.2 List of parameters" and "5.7 List of control data" for details on the setting details.

- (b) The following shows the speed change time chart.

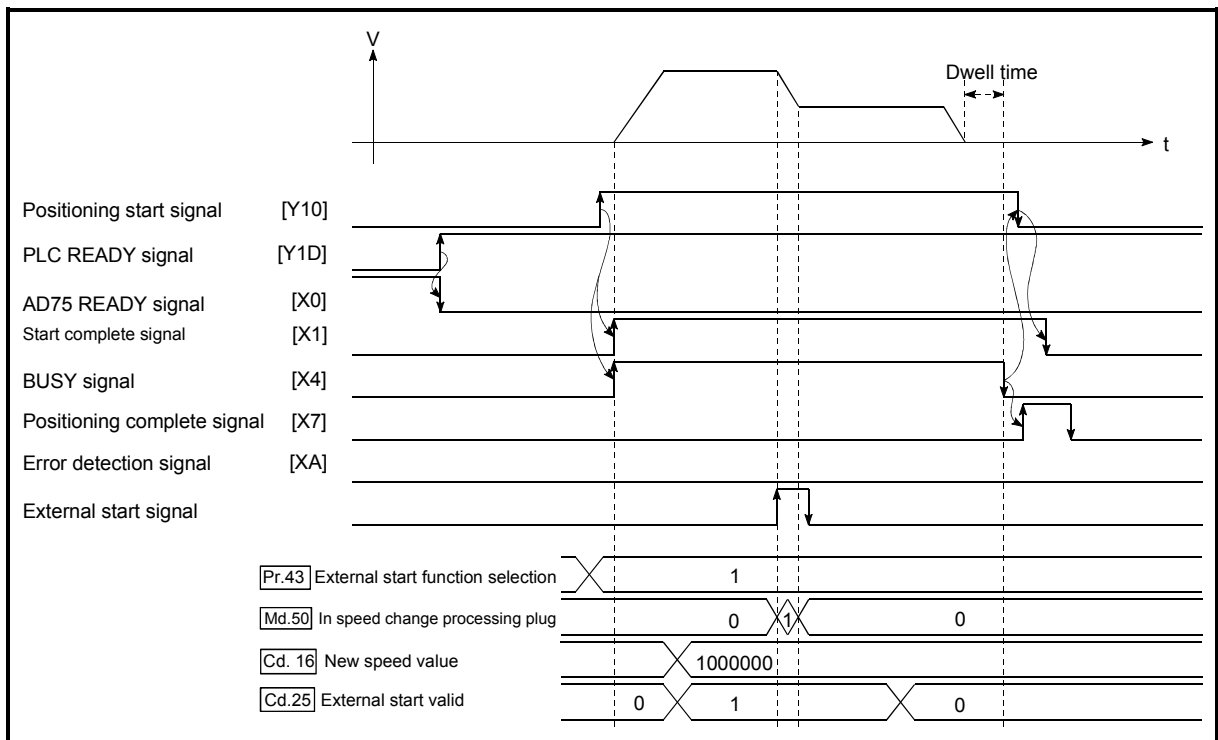
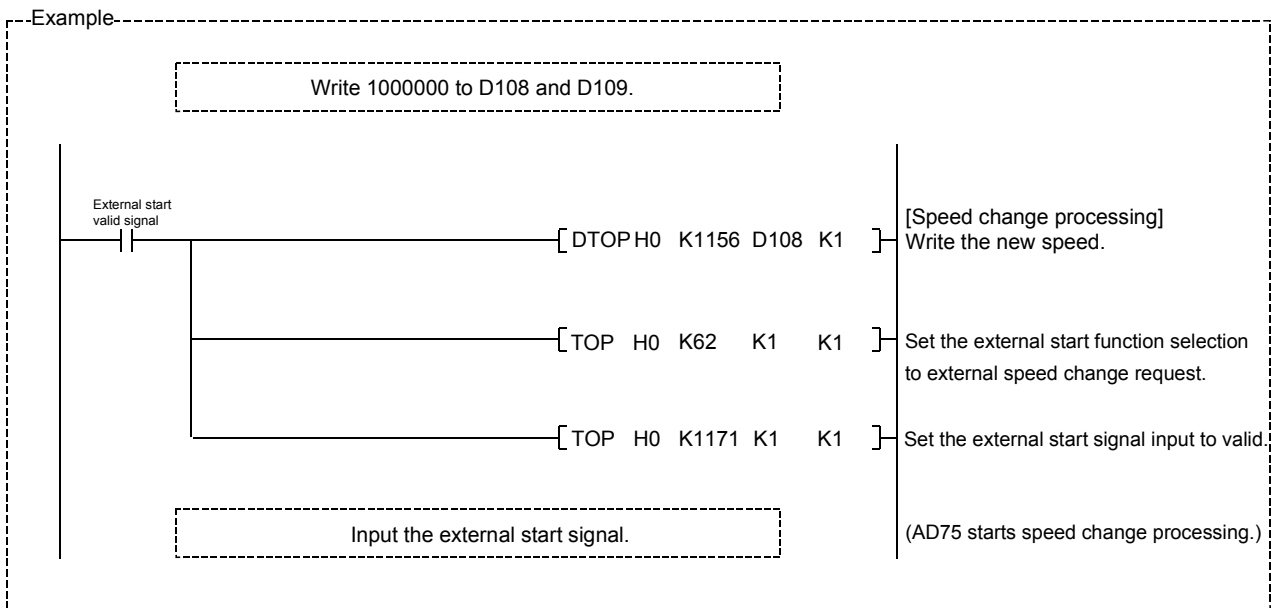

Fig. 12.26 Time chart for changing the speed using an external start signal

(c) Add the following sequence program to the control program, and write it to the PLC CPU.



12.5.2 Override function

The override function changes the command speed by a designated percentage (1 to 300%) for all control to be executed.

The speed can be changed by setting the percentage (%) by which the speed is changed in "[Cd.18] Positioning operation speed override".

- (1) Control details
- (2) Precautions during control
- (3) Setting the override function

(1) Control details

The following shows that operation of the override function.

- 1) A value changed by the override function is monitored by "[Md.31] Feedrate".
- 2) If "[Cd.18] Positioning operation speed override" is set to 100%, the speed will not change.
- 3) If "[Cd.18] Positioning operation speed override" is set a value less than 100%, control will be carried out at speed unit "1" at the time "[Md.31] Feedrate" becomes a value of "1" or less.
- 4) If there is not enough remaining distance to change the speed when the speed is changed during the position control of speed/position changeover control, the operation will be carried out at the speed that could be changed.
- 5) If the speed changed by the "override function" is greater than the "[Pr.7] Speed limit value", a warning "speed limit value over" (warning code: 501) will occur and the speed will be controlled at the "[Pr.7] Speed limit value". The "[Md.49] In speed limit flag" will turn ON.

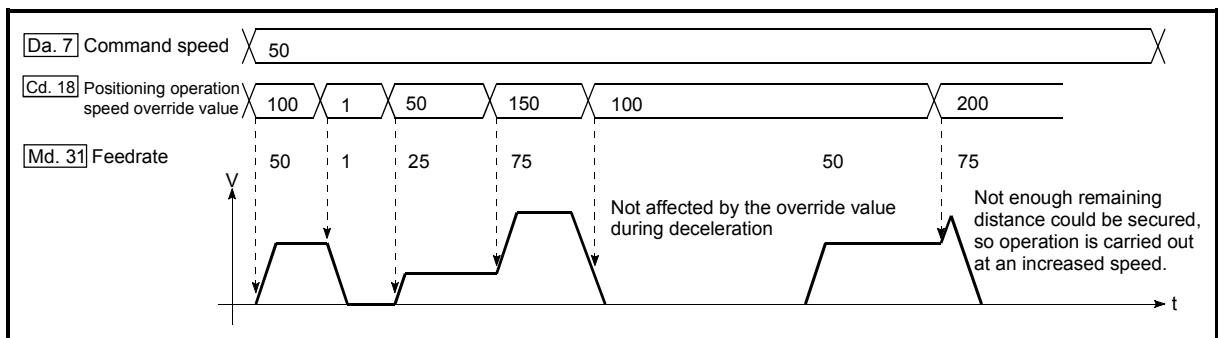

Fig. 12.27 Override function operation

(2) Precaution during control

- (a) When changing the speed during continuous path control, the speed change will be ignored if there is not enough distance remaining to carry out the change.
- (b) A warning "deceleration and stop speed change" (warning code: 500) occurs and the speed cannot be changed in the following cases.
 - During deceleration by a stop command
 - During automatic deceleration during positioning control
- (c) When the speed is changed during interpolation control, the required speed is set in the reference axis.

(3) Setting the override function

The following shows the data settings and sequence program example for setting the override value of axis 1 to "200%".

- (a) Set the following data. (Use the start time chart shown in section (2) below as a reference, and set using the sequence program shown in section (3).)

Setting item	Setting value	Setting details	Buffer memory address		
			Axis 1	Axis 2	Axis 3
Cd.18 Positioning operation speed override	200	Set the new speed as a percentage (%).	1159	1209	1259

* Refer to section "5.7 List of control data" for details on the setting details.

- (b) The following shows a time chart for changing the speed using the override function.

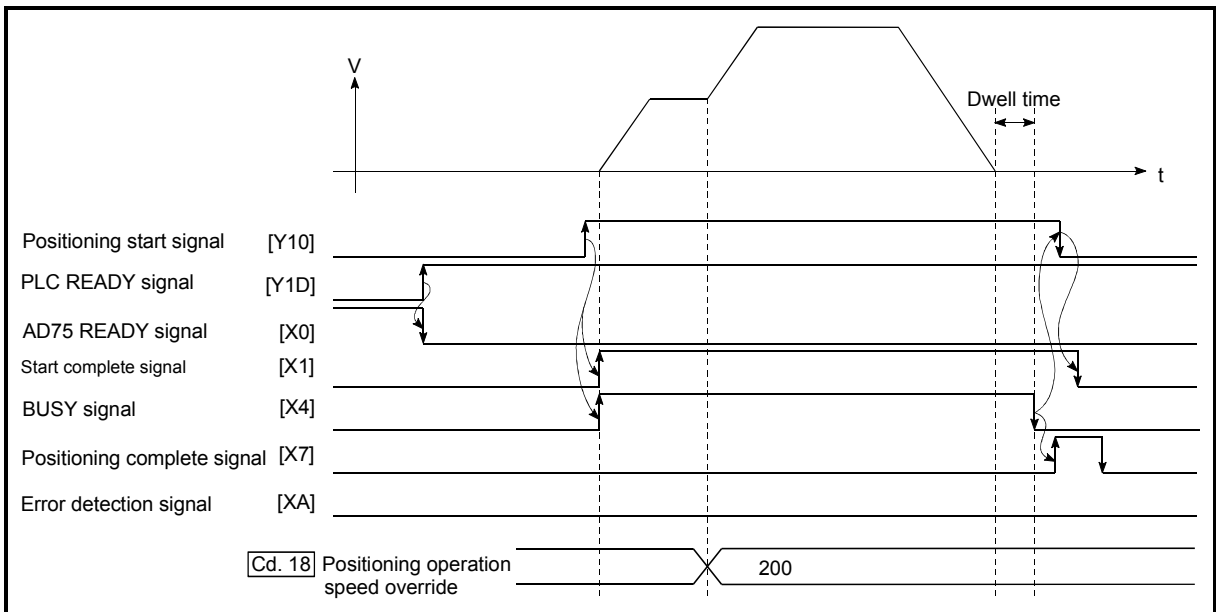
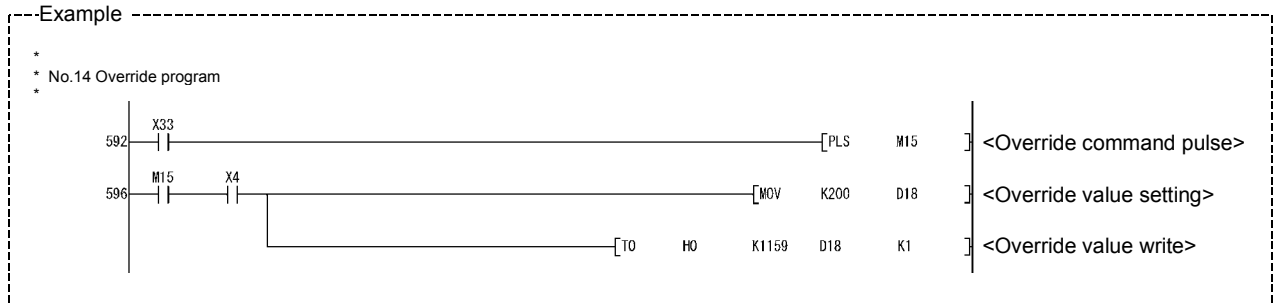

Fig. 12.28 Time chart for changing the speed using the override function

(c) Add the following sequence program to the control program, and write it to the PLC CPU.



12.5.3 Acceleration/deceleration time change function

The "acceleration/deceleration time change function" is used to change the acceleration/deceleration time during a speed change to a random value when carrying out the speed change indicated in section "12.5.1 Speed change function". In a normal speed change (when the acceleration/deceleration time is not changed), the acceleration/deceleration time previously set in the parameters (Pr.8, Pr.9, and Pr.26 to Pr.31 values) is set in the positioning parameter data items Da.3 and Da.4, and control is carried out with that acceleration/deceleration time. However, by setting the new acceleration/deceleration time (Cd.33, Cd.34) in the control data, and issuing an acceleration/deceleration time change enable command (Cd.35 Acceleration/deceleration time change during speed change, enable/disable selection) to change the speed when the acceleration/deceleration time change is enabled, the speed will be changed with the new acceleration/deceleration time (Cd.33, Cd.34).

The details shown below explain about the "acceleration/deceleration time change function".

- (1) Control details
- (2) Precautions during control
- (3) Setting the acceleration/deceleration time change function

(1) Control details

The following drawing shows the operation during an acceleration/deceleration time change.

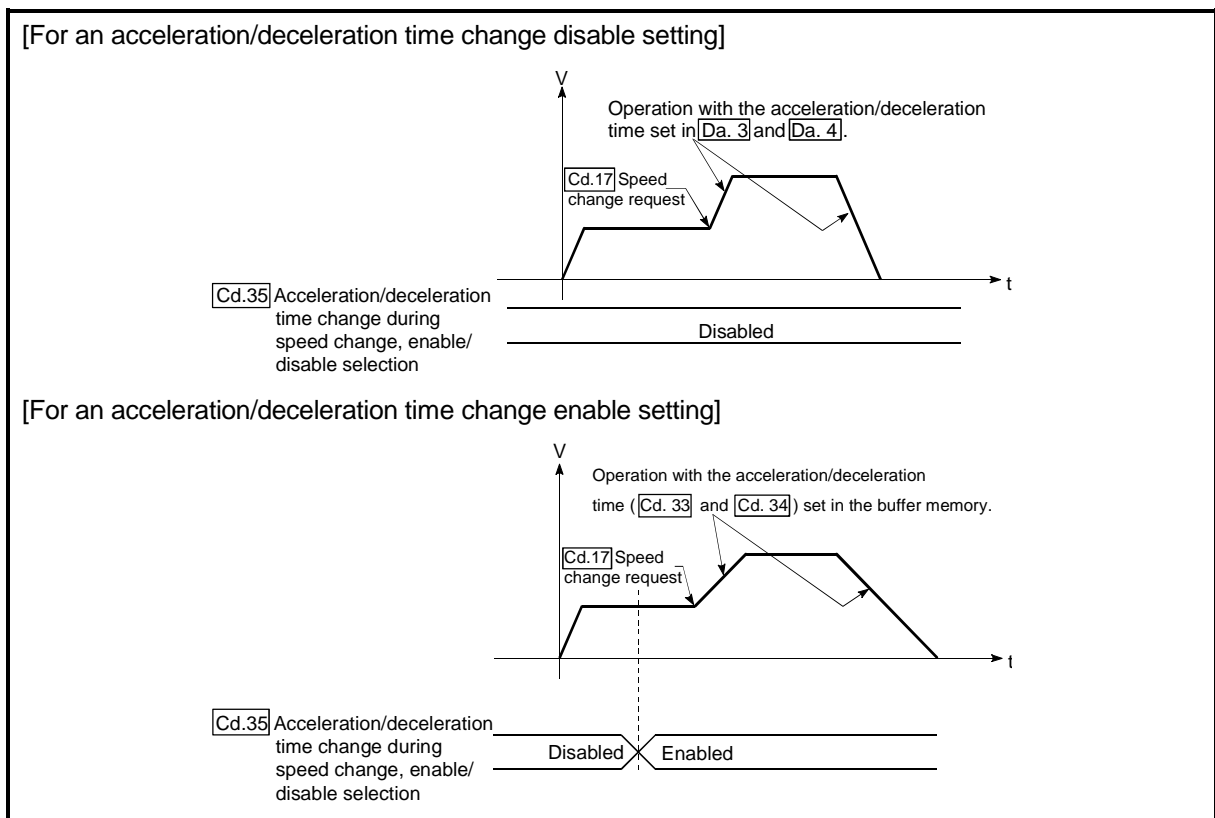
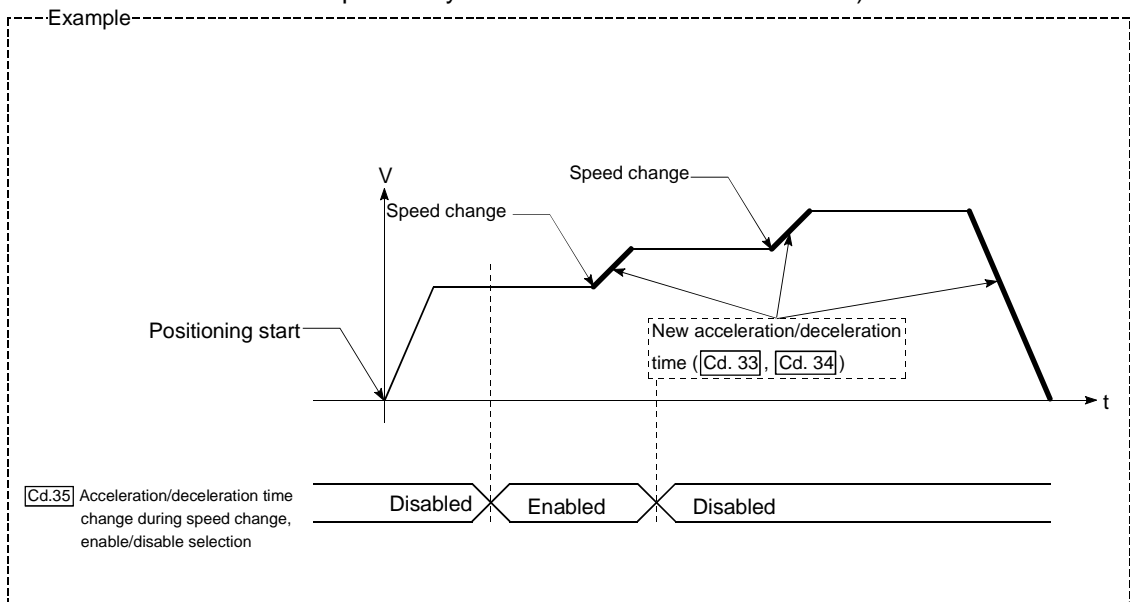

Fig. 12.29 Operation during an acceleration/deceleration time change

(2) Precautions during control

- (a) When "0" is set in "[Cd.33] New acceleration time value" and "[Cd.34] New deceleration time value", the acceleration/deceleration time will not be changed even if the speed is changed. In this case, the operation will be controlled at the acceleration/deceleration time previously set in the parameters.
- (b) The "new acceleration/deceleration time" is valid during execution of the positioning data for which the speed was changed. In continuous positioning control and continuous path control, the speed is changed and control is carried out with the previously set acceleration/deceleration time at the changeover to the next positioning data, even if the acceleration/deceleration time is changed to the "new acceleration/deceleration time ([Cd.33], [Cd.34])".
- (c) Even if the acceleration/deceleration time change is set to disable after the "new acceleration/deceleration time" is validated, the positioning data for which the "new acceleration/deceleration time" was validated will continue to be controlled with that value. (The next positioning data will be controlled with the previously set acceleration/deceleration time.)



- (d) If the "new acceleration/deceleration time" is set to "0" and the speed is changed after the "new acceleration/deceleration time" is validated, the operation will be controlled with the previous "new acceleration/deceleration time".

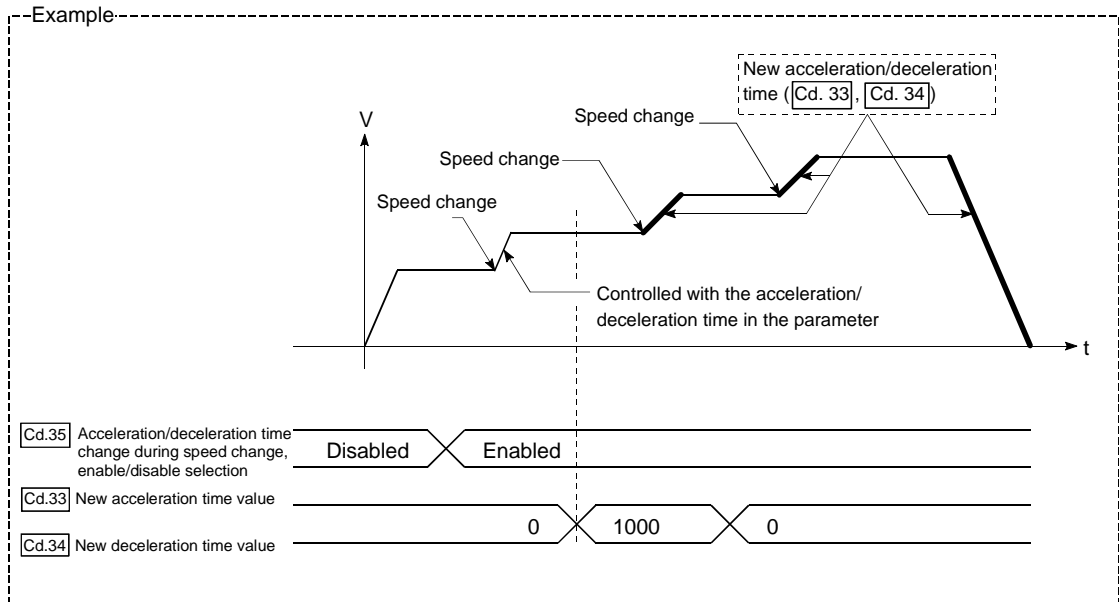

- (e) During JOG operation, the acceleration/deceleration time change function does not function.

POINT

If the speed is changed when an acceleration/deceleration change is enabled, the "new acceleration/deceleration time" will become the acceleration/deceleration time of the positioning data being executed. The "new acceleration/deceleration time" remains valid until the changeover to the next positioning data. (The automatic deceleration processing at the completion of the positioning will also be controlled by the "new acceleration/deceleration time".)

(3) Setting the acceleration/deceleration time change function

To use the "acceleration/deceleration time change function", write the data shown in the following table to the AD75 using the sequence program.

The set details are validated when a speed change is executed after the details are written to the AD75.

Setting item	Setting value	Setting details	Buffer memory address		
			Axis 1	Axis 2	Axis 3
Cd.33	New acceleration time value	→ Set the new acceleration time.	1184 1185	1234 1235	1284 1285
Cd.34	New deceleration time value	→ Set the new deceleration time.	1186 1187	1236 1237	1286 1287
Cd.35	Acceleration/deceleration time change during speed change, enable/disable selection	1 Set "1: Acceleration/deceleration time change enable".	1188	1238	1288

* Refer to section "5.7 List of control data" for details on the setting details.

12.5.4 Torque change function

The "torque change function" is used to change the torque limit value during torque limiting.

The torque limit value during torque limiting is normally the value set in the "[Pr.18] Torque limit setting value" that was previously set in the parameters. However, by setting the new torque limit value in the positioning data "[Cd.30] New torque value", and writing it to the AD75, the torque generated by the servomotor during control can be limited with the new torque value.

(The "[Cd.30] New torque value" is validated when written to the AD75.)

The details shown below explain about the "control torque change function".

- (1) Control details
- (2) Precautions during control
- (3) Setting the torque change function start signal

(1) Control details

The following drawing shows the torque change operation.

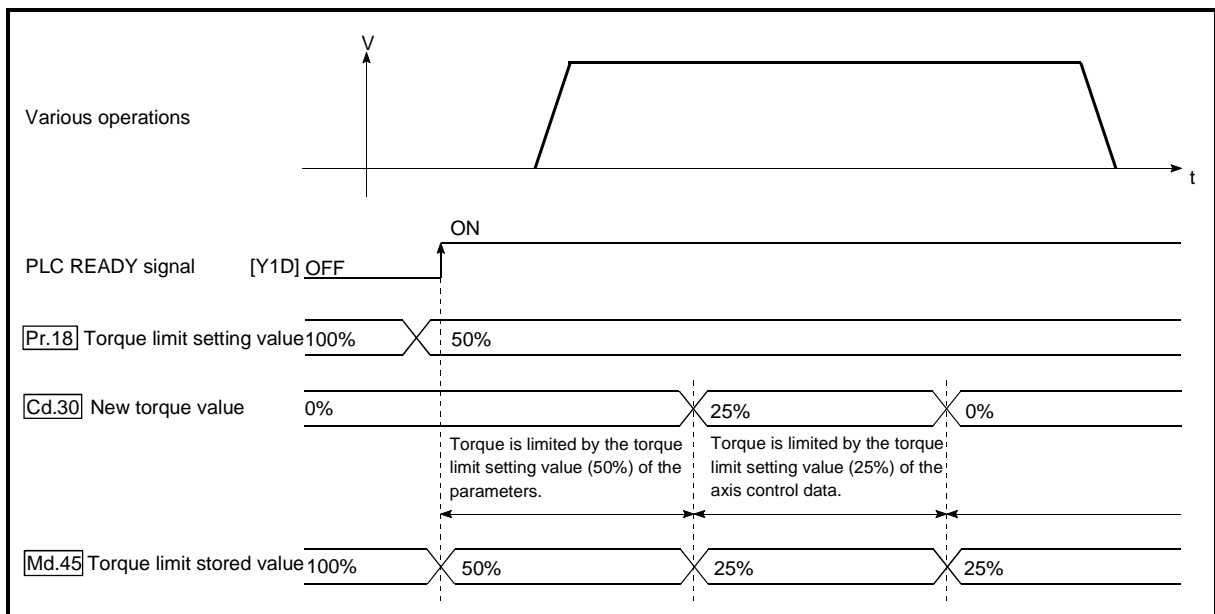

Fig. 12.30 Torque change operation

(2) Precautions during control

- (a) If a value besides "0" is set in the "[Cd.30] New torque value", the torque generated by the servomotor will be limited by that value. To limit the torque with the value set in "[Pr.18] Torque limit setting value", set the "[Cd.30] New torque value" to "0".
- (b) The "[Cd.30] New torque value" is validated when written to the AD75.
- (c) If the setting value is outside the setting range, a warning "Outside torque change value range" (warning code: 113) will occur and the torque will not be changed.

(3) Setting the torque change function start signal

To use the "torque change function", write the data shown in the following table to the AD75 using the sequence program.

The set details are validated when written to the AD75.

Setting item		Setting value	Setting details	Buffer memory address		
				Axis 1	Axis 2	Axis 3
Cd.30	New torque value	→	Set the new torque limit value.	1176	1226	1276

* Refer to section "5.7 List of control data" for details on the setting details.

12.6 Other functions

Other functions include the "step function", "skip function", "M code output function", "teaching function", "command in-position function", "stepping motor mode function", "acceleration/deceleration processing function" and "indirectly specification function". Each function is executed by parameter setting or sequence program creation and writing.

12.6.1 Step function

The "step function" is used to confirm each operation of the positioning control one by one.

It is mainly used in debugging work for positioning control, etc.

A positioning operation in which a "step function" is used is called a "step operation". In step operations, the timing for stopping the control can be set. (This is called the "step mode".) Control stopped by a step operation can be continued by setting "step continue" (to continue the control)" or restarted by setting "restart" in the "step start information".

The details shown below explain about the "step function".

- (1) Relation between the step function and various controls
- (2) Step mode
- (3) Step start information
- (4) Using the step operation
- (5) Control details
- (6) Precautions during control
- (7) Step function settings

(1) Relation between the step function and various controls

The following table shows the relation between the "step function" and various controls.

Control type		Step function	Step applicability
Zero point return control	Machine zero point return control	×	Step operation not possible
	High-speed zero pint return control	×	
Main positioning control	Position control	1-axis linear control	Step operation possible
		2-axis linear interpolation control	
		1-axis fixed-dimension feed control	
		2-axis fixed-dimension feed control (interpolation)	
	2-axis circular interpolation control	○	
	Speed control	×	Step operation not possible
	Speed/position changeover control	○	Step operation possible
Other control	Current value change	○	
	JUMP command	○	
Manual control	JOG operation	×	Step operation not possible
	Manual pulse generator operation	×	

○ : Set when required. × : Setting not possible

(2) Step mode

In step operations, the timing for stopping the control can be set. This is called the "step mode". (The "step mode" is set in the control data "[Cd.27] Step mode".)

The following shows the two types of "step mode" functions.

(a) Deceleration unit step

The operation stops at positioning data requiring automatic deceleration. (A normal operation will be carried out until the positioning data requiring automatic deceleration is found. Once found, that positioning data will be executed, and the operation will then automatically decelerate and stop.)

(b) Data No. unit step

The operation automatically decelerates and stops for each positioning data. (Even in continuous path control, an automatic deceleration and stop will be forcibly carried out.)

(3) Step start information

Control stopped by a step operation can be continued by setting "step continue" (to continue the control) or restarted by setting "restart" in the "step start information". (The "step start information" is set in the control data "[Cd.28] Step start information".)

The following table shows the results of starts using the "step start information" during step operation.

(Warnings will only be output when the step valid flag is ON.)

Stop status in the step operation	[Md.35] Axis operation status	[Cd.28] Step start information	Step start results
1 step of positioning stopped normally	Step standing by	1: Step continue	The next positioning data is executed.
		2: Restart	A "step start information invalid warning" occurs.
Control stopped by a stop signal	Step stopped	1: Step continue	A restart is carried out at the positioning data where the control was stopped.
		2: Restart	
An error occurred, and the control stopped	Step error occurring	1: Step continue	A "step start information invalid warning" occurs.
		2: Restart	

The following warnings will occur if the "[Md.35] Axis operation status" is not appropriate when step start information is set.

[Md.35] Axis operation status	Step start results
Standing by	Step start information invalid warning
Stopped	
Error occurring	
In interpolation	Start during operation warning
In JOG operation	
In manual pulse generator operation	
Analyzing	
Waiting for special start	
In zero point return	
In position control	
In speed control	
In speed control of speed/position changeover control	
In position control of speed/position changeover control	

(4) Using the step operation

The following shows the procedure for checking positioning data using the step operation.

- (a) Turn ON the step valid flag before starting the positioning data.
(Write "1" (carry out step operation) in "Cd.26 Step valid flag".)
- (b) Set the step mode before starting the positioning data.
(Set in "Cd.27 Step mode".)
- (c) Turn ON the positioning start signal, and check that the positioning control starts normally.
- (d) The control will stop for the following reasons.
 - 1) One step of positioning stopped normally. (Go to step (f))
 - 2) Control stopped by a stop signal (Take appropriate measures, go to step (e))
 - 3) An error occurred and the control stopped. (Take appropriate measures, go to step (c))
- (e) Write "2" (restart) to "Cd.28 Step start information", and check that the positioning data where the control stopped operates normally. (Go to (d)).
- (f) Write "1" (step continue) to "Cd.28 Step start information", and check that the next positioning data where the control stopped operates normally.
 - 1) One step of positioning stopped normally. (Go to step (f))
 - 2) Control stopped by a stop signal (Take appropriate measures, go to step (e))
 - 3) An error occurred and the control stopped. (Take appropriate measures, go to step (c))
 - 4) All positioning data operated normally (Go to step (g))
- (g) Turn OFF the step valid flag, and quit the "step function".
(Write "0" (do not carry out step operation) in "Cd.26 Step valid flag".)

(5) Control details

(a) The following drawing shows a step operation during a "deceleration unit step".

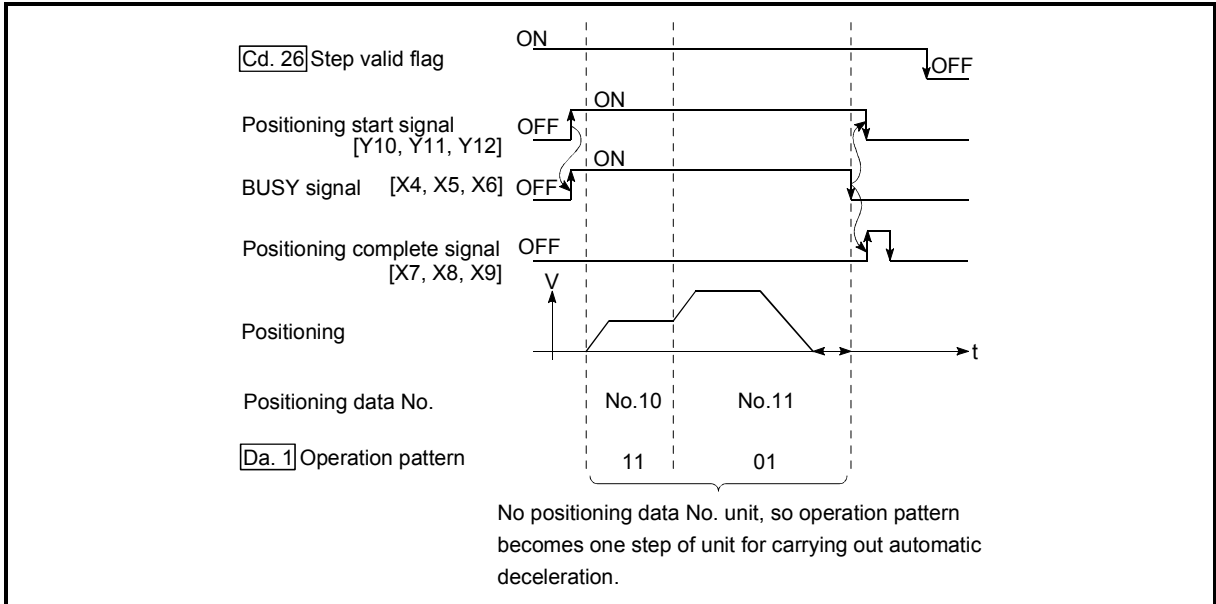

Fig. 12.31 Operation during step execution by deceleration unit step

(b) The following drawing shows a step operation during a "data No. unit step".

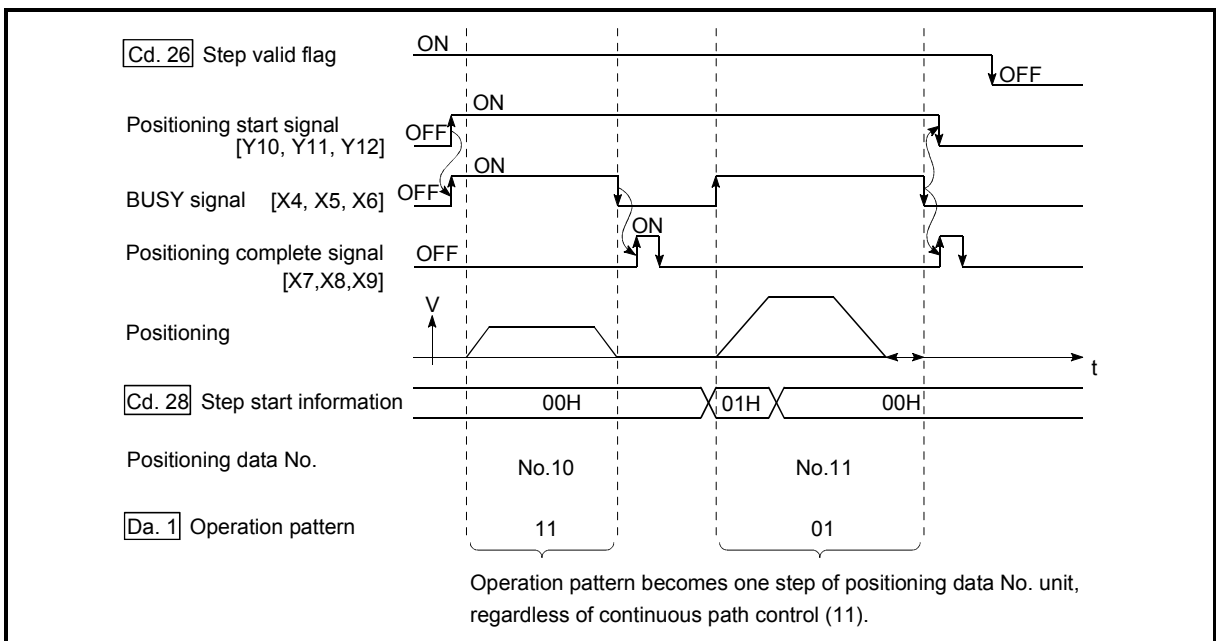

Fig. 12.32 Operation during step execution positioning data No. unit step

(6) Precautions during control

- (a) When step operation is carried out using interpolation control positioning data, the step function settings are carried out for the reference axis.
- (b) When the step valid flag is ON, the step operation will start from the beginning if the positioning start signal is turned ON while "[Md.35] Axis operation status" is "step standing by", "step stopped", or "step error occurring". (The step operation will be carried out from the positioning data set in "[Cd.11] Positioning start No.".)

(7) Step function settings

To use the "step function", write the data shown in the following table to the AD75 using the sequence program. Refer to section "(4) Using the step operation" for the timing of the settings.

The set details are validated when written to the AD75.

Setting item		Setting value	Setting details	Buffer memory address		
				Axis 1	Axis 2	Axis 3
[Cd.26]	Step valid flag	1	Set "1: Carry out step operation".	1172	1222	1272
[Cd.27]	Step mode	→	Set "0: Deceleration unit step" or "1: Data No. unit step".	1173	1223	1273
[Cd.28]	Step start information	→	Set "1: Step continue" or "2: Restart", depending on the stop status.	1174	1224	1274

* Refer to section "5.7 List of control data" for details on the setting details.

12.6.2 Skip function

The "skip function" is used to stop (deceleration stop) the control of the positioning data being executed at the time of the skip signal input, and execute the next positioning data.

A skip is executed by a skip command ([Cd.29](#) Skip command) or external start signal. The "skip function" can be used during control in which positioning data is used.

The details shown below explain about the "skip function".

- (1) Control details
- (2) Precautions during control
- (3) Setting the skip function from the PLC CPU
- (4) Setting the skip function using an external start signal

(1) Control details

The following drawing shows the skip function operation.

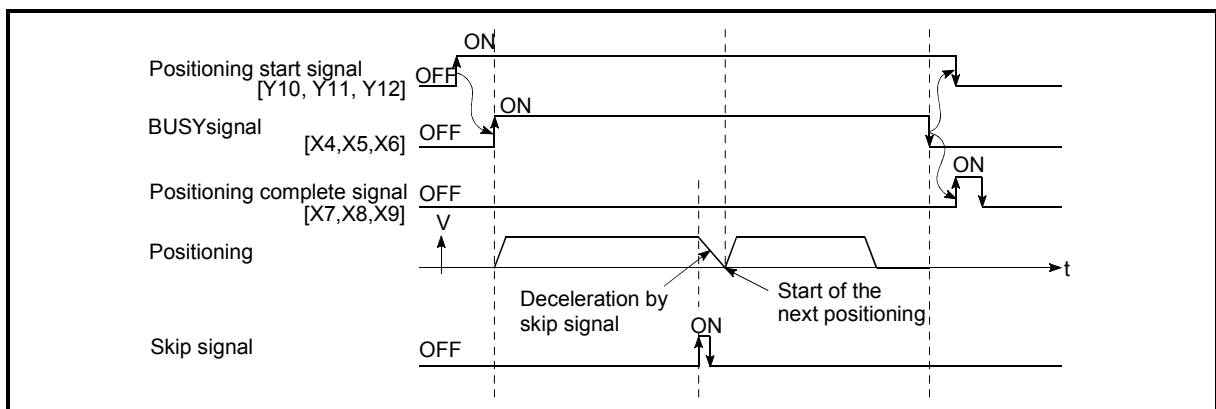

Fig. 12.33 Operation when a skip signal is input during positioning control

(2) Precautions during control

- (a) If the skip signal is turned ON at the last of an operation, a deceleration stop will occur and the operation will be terminated.
- (b) When a control is skipped (when the skip signal is turned ON during a control), the positioning complete signals (X7, X8, X9) will not turn ON.
- (c) When the skip signal is turned ON during the dwell time, the remaining dwell time will be ignored, and the next positioning data will be executed.
- (d) When a control is skipped during interpolation control, the reference axis skip signal is turned ON. When the reference axis skip signal is turned ON, a deceleration stop will be carried out for both axes, and the next reference axis positioning data will be executed.
- (e) The M code ON signals (XD, XE, XF) will not turn ON when the M code output is set to the AFTER mode (when "1: AFTER mode" is set in "[Pr.19](#) M code ON signal output timing").
(In this case, the M code will not be stored in "[Md.32](#) Valid M code".)

(3) Setting the skip function from the PLC CPU

The following shows the settings and sequence program example for skipping the control being executed in axis 1 with a command from the PLC CPU.

- (a) Set the following data.
(The setting is carried out using the sequence program shown below in section (2)).

Setting item	Setting value	Setting details	Buffer memory address			
			Axis 1	Axis 2	Axis 3	
Cd.29	Skip command	1	Set "1: Skip request".	1175	1225	1275

* Refer to section "5.7 List of control data" for details on the setting details.

- (b) Add the following sequence program to the control program, and write it to the PLC CPU.

- 1) When the "skip command" is input, the value "1" (skip request) set in "Cd.29 Skip command" is written to the AD75 buffer memory (1175).

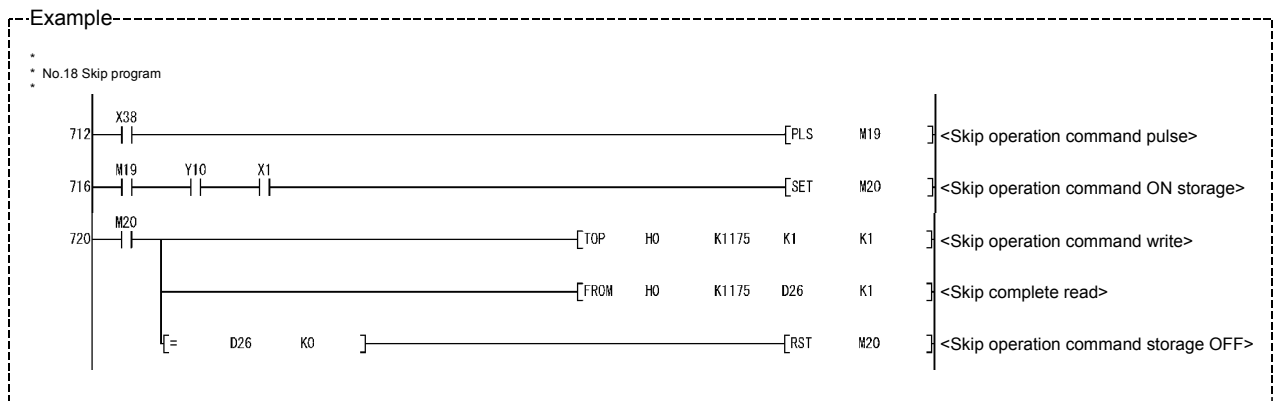

(4) Setting the skip function using an external start signal

The skip function can also be executed using an "external start signal".
 The following shows the settings and sequence program example for skipping the control being executed in axis 1 using an "external start signal".

- (a) Set the following data to execute the skip function using an external start signal.
 (The setting is carried out using the sequence program shown below in section (2)).

Setting item	Setting value	Setting details	Buffer memory address		
			Axis 1	Axis 2	Axis 3
Pr.43	External start function selection	2	Set "2: Skip request".		
Cd.25	External start valid	1	Set "1: Validate external start".		
			62	212	362
			1171	1221	1271

* Refer to section "5.7 List of control data" for details on the setting details.

- (b) Add the following sequence program to the control program, and write it to the PLC CPU.

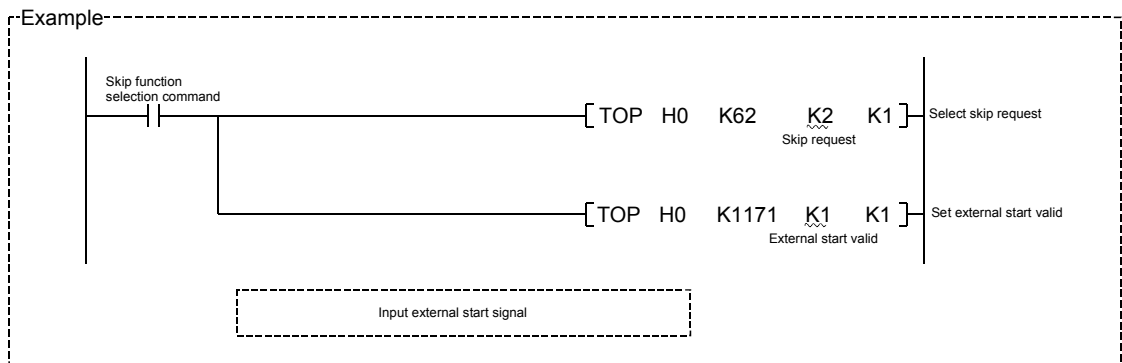

12.6.3 M code output function

The "M code output function" is used to command auxiliary work (clamping, drill rotation, tool replacement, etc.) related to the positioning data being executed. When the M code ON signal (XD, XE, XF) is turned ON during positioning execution, a No. called the M code is stored in "[Md.32] Valid M code". These "[Md.32] Valid M code" are read from the PLC CPU, and used to command auxiliary work. M codes can be set for each positioning data. (Set in setting item "[Da.9] M code" of the positioning data.) The timing for outputting (storing) the M codes can also be set in the "M code output function".

The details shown below explain about the "M code output function".

- (1) M code ON signal output timing
- (2) M code OFF request
- (3) Precautions during control
- (4) Setting the M code output function
- (5) Reading M codes

(1) M code ON signal output timing

The timing for outputting (storing) the M codes can be set in the "M code output function". (The M code is stored in "[Md.32] Valid M code" when the M code ON signal is turned ON.)

The following shows the two types of timing for outputting M codes: the "WITH" mode and the "AFTER" mode.

(a) WITH mode

The M code ON signal (XD, XE, XF) is turned ON at the positioning start, and the M code is stored in "[Md.32] Valid M code".

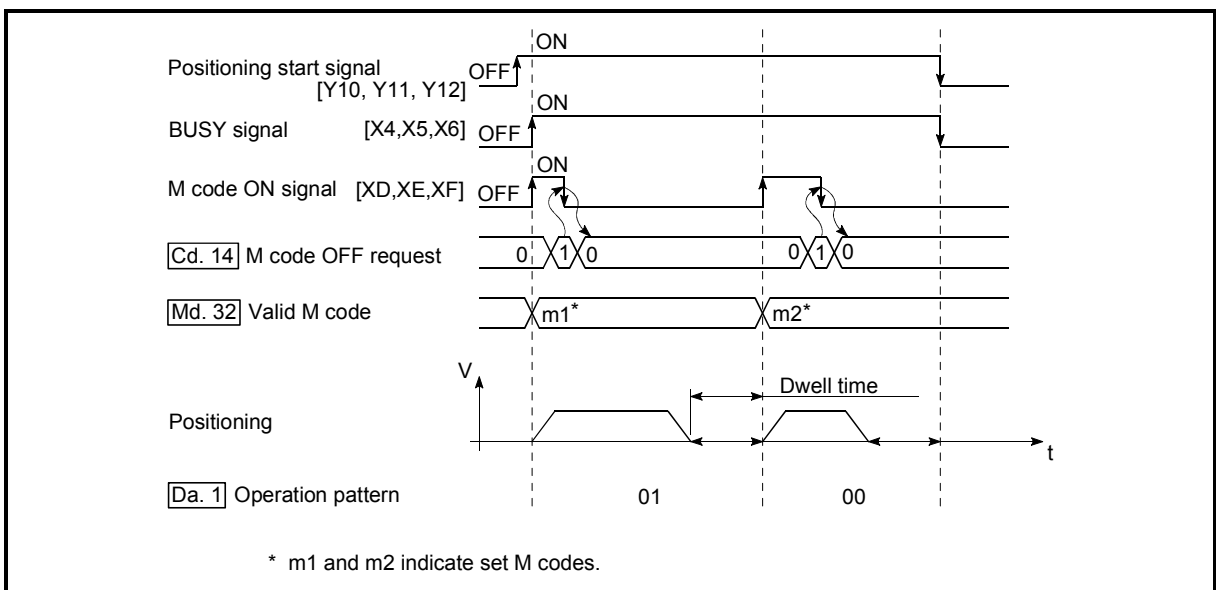

Fig. 12.34 M code ON/OFF timing (WITH mode)

(b) AFTER mode

The M code ON signal (XD, XE, XF) is turned ON at the positioning completion, and the M code is stored in "Md.32 Valid M code".

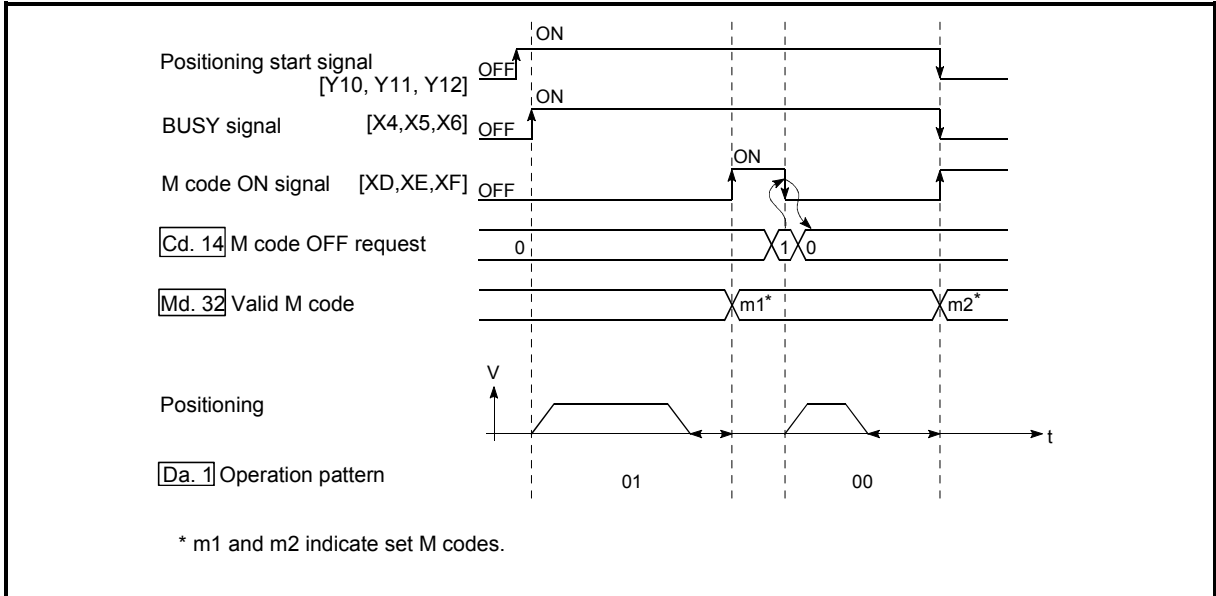

Fig. 12.35 M code ON/OFF timing (AFTER mode)

(2) M code OFF request

When the M code ON signal (XD, XE, XF) is ON, it must be turned OFF by the sequence program.

To turn OFF the M code ON signal, set "1" (turn OFF the M code signal) in "Cd.14 M code OFF request".

Setting item	Setting value	Setting details	Buffer memory address		
			Axis 1	Axis 2	Axis 3
Cd.14 M code OFF request	1	Set "1": Turn OFF the M code ON signal.	1153	1203	1253

* Refer to section "5.7 List of control data" for details on the setting details.

The next positioning data will be processed as follows if the M code ON signal is not turned OFF. (The processing differs according to the "Da.1 Operation pattern".)

Da.1 Operation pattern	Processing
00 Independent positioning control (Positioning complete)	The next positioning data will not be executed until the M code ON signal is turned OFF.
01 Continuous positioning control	The next positioning data will be executed, but a warning "M code ON signal ON start" (warning code: 503) will occur.

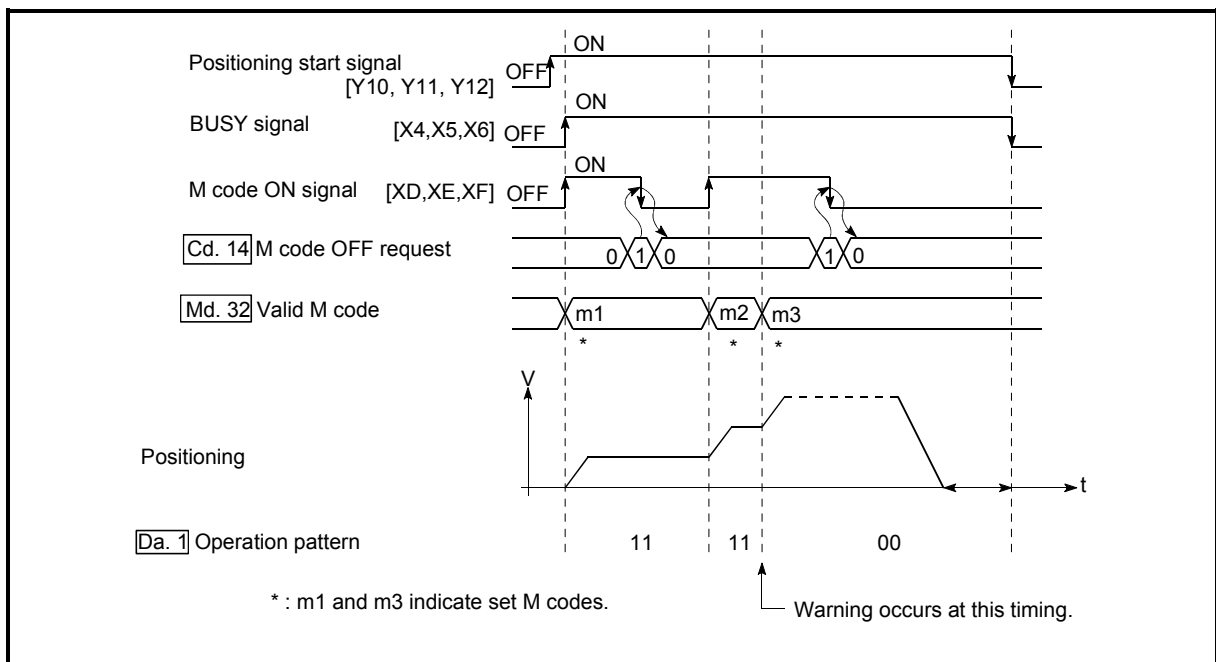

Fig. 12.36 Warning due to an M code ON signal during continuous path control

POINT

If the M code output function is not required, set a "0" in setting item "**Da.9** M code" of the positioning data.

(3) Precautions during control

- (a) During interpolation control, the reference axis M code ON signal is turned ON.
- (b) The M code ON signal will not turn ON if "0" is set in "**Da.9** M code". (The M code will not be output, and the previously output value will be held in "**Md.32** Valid M code".)
- (c) If the M code ON signal is ON at the positioning start, an error "M code ON signal ON start" (error code: 536) will occur, and the positioning will not start.
- (e) If the PLC READY signal (Y1D) is turned OFF, the M code ON signal will turn OFF and "0" will be stored in "**Md.32** Valid M code".
- (f) If the positioning operation time is short during continuous path control, there will not be enough time to turn OFF the M code ON signal, and a warning may occur. In this case, set a "0" in the "**Da.9** M code" of that section's positioning data.
- (g) In the AFTER mode during speed control, the M code is not output and the M code ON signal does not turn ON.

(4) Setting the M code output function

The following shows the settings to use the "M code output function".

- (a) Set the M code No. in the positioning data "[Da.9] M code".
- (b) Set the timing to output the M code ON signal (XD, XE, XF).

Set the required value in the following parameter, and write it to the AD75.

The set details are validated at the rising edge (OFF → ON) of the PLC READY signal (Y1D).

Setting item	Setting value	Setting details	Buffer memory address		
			Axis 1	Axis 2	Axis 3
[Pr.19] M code ON signal output timing	→	Set the timing to output the M code ON signal. 0: WITH mode 1: AFTER mode	25	175	325

* Refer to section "5.2 List of parameters" for setting details.

(5) Reading M codes

"M codes" are stored in the following buffer memory when the M code ON signal turns ON.

Monitor item	Monitor value	Storage details	Buffer memory address		
			Axis 1	Axis 2	Axis 3
[Md.32] Valid M code	→	The M code No. ([Da.9] M code) set in the positioning data is stored.	806	906	1006

* Refer to section "5.6 List of monitor data" for information on the storage details.

The following shows a sequence program example for reading the "[Md.32] Valid M code" to the PLC CPU data register (D110). (The read value is used to command the auxiliary work.)

Read M codes not as "rising edge commands", but as "ON execution commands".

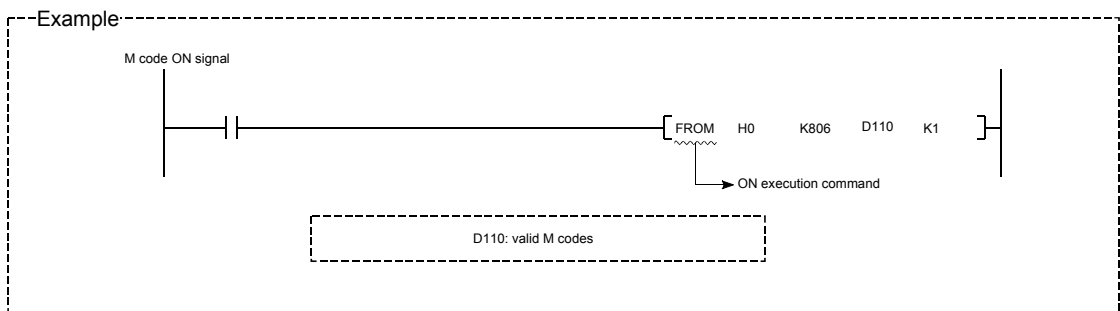

12.6.4 Teaching function

The "teaching function" is used to set addresses aligned using the manual control (JOG operation, manual pulse generator operation) in the positioning data addresses ([Da.5] Positioning address/movement amount, [Da.6] Arc address).

The details shown below explain about the "teaching function".

- (1) Control details
- (2) Precautions during control
- (3) Data used in teaching
- (4) Teaching procedure

(1) Control details

(a) Teaching timing

Teaching is executed using the sequence program when the BUSY signal (X4, X5, X6) is OFF. (During manual control, teaching can be carried out as long as the axis is not BUSY, even when an error or warning has occurred.)

(b) Addresses for which teaching is possible

The addresses for which teaching is possible are "[Md.29] Current feed value" having the zero point as a reference. The settings of the "movement amount" used in increment system positioning cannot be used. In the teaching function, these "current feed values" are set in the "[Da.5] Positioning address/movement amount" or "[Da.6] Arc address".

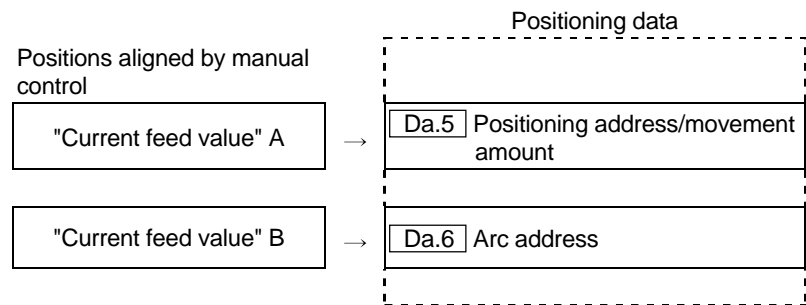

(c) Teaching target axis ([Cd.4] Target axis)

Teaching can be executed for the "designated axis only" or the "2 axes carrying out interpolation control". When teaching is executed for the "2 axes carrying out interpolation control", the "current feed value" is set for both the reference axis and the interpolation axis.

(2) Precautions during control

- (a) Before teaching, a "machine zero point return" must be carried out to establish the zero point. (When a current value change function, etc., is carried out, "[Md.29] Current feed value" may not show absolute addresses having the zero point as a reference.)
- (b) Teaching cannot be carried out for positions to which movement cannot be executed by manual control (positions to which the workpiece cannot physically move). (During center point designation circular interpolation control, etc., teaching of "[Da.6] Arc address" cannot be carried out if the center point of the arc is not within the moveable range of the workpiece.)
- (c) Writing to the flash ROM can be executed up to 100,000 times.
Writing to the flash ROM will become impossible after 100,000 times.

(3) Data used in teaching

The following control data is used in teaching.

Setting item		Setting value	Setting details	Buffer memory address		
				Axis 1	Axis 2	Axis 3
[Cd.4]	Target axis	→	Set the writing destination axis. 1: Axis 1 2: Axis 2 3: Axis 3 4: Interpolation of axis 1 and axis 2 5: Interpolation of axis 2 and axis 3 6: Interpolation of axis 3 and axis 1	1103		
[Cd.5]	Positioning data No.	→	Set the "positioning data No."(1 to 600) of the writing destination.	1104		
[Cd.6]	Write pattern	→	Set the address to which the "current feed value" will be written. 5: Write to the "[Da.5] Positioning address/movement amount" 6: Write to the "[Da.6] Arc address".	1105		
[Cd.7]	Read/write request	2	Request writing to the positioning data.	1106		
[Cd.9]	Flash ROM write request	1	Write the set details to the flash ROM (backup the changed data).	1138		

* Refer to section "5.7 List of control data" for details on the setting details.

(4) Teaching procedure

The following shows the procedure for a teaching operation.

(a) When teaching to the "[Da.5] Positioning address/movement amount"

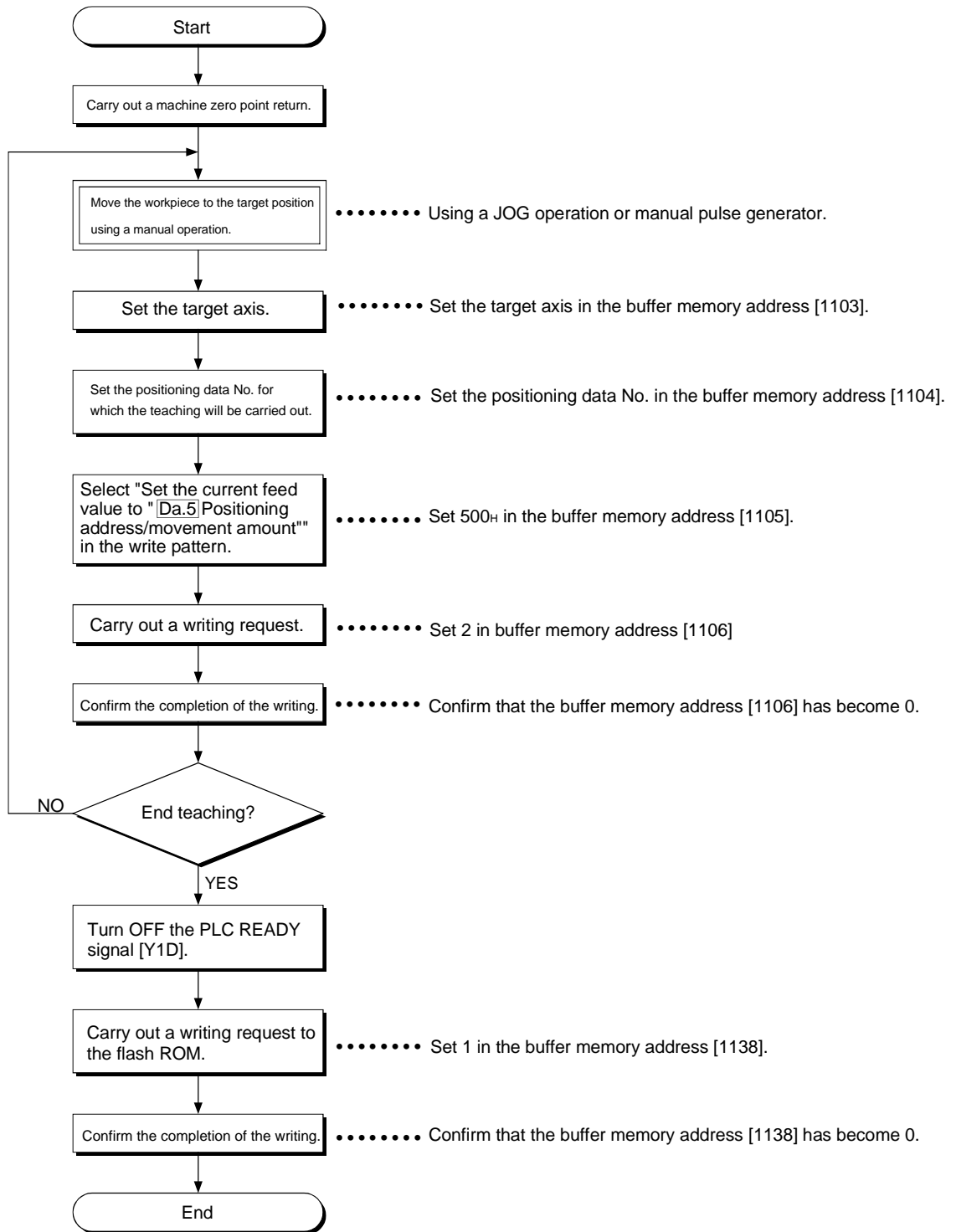

(b) When teaching to the "[Da.6] Arc address", then teaching to the "[Da.5] Positioning address/movement amount"

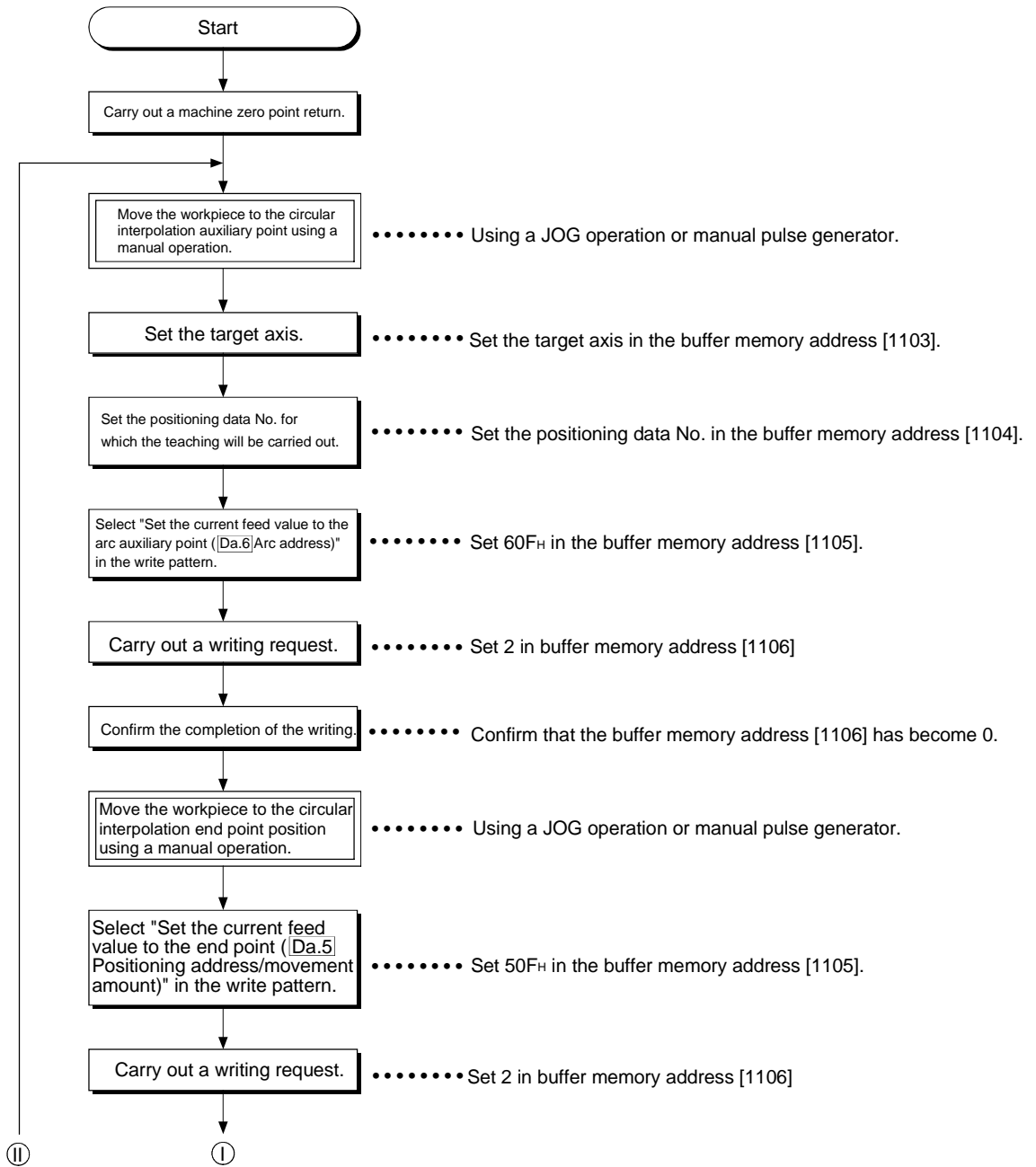

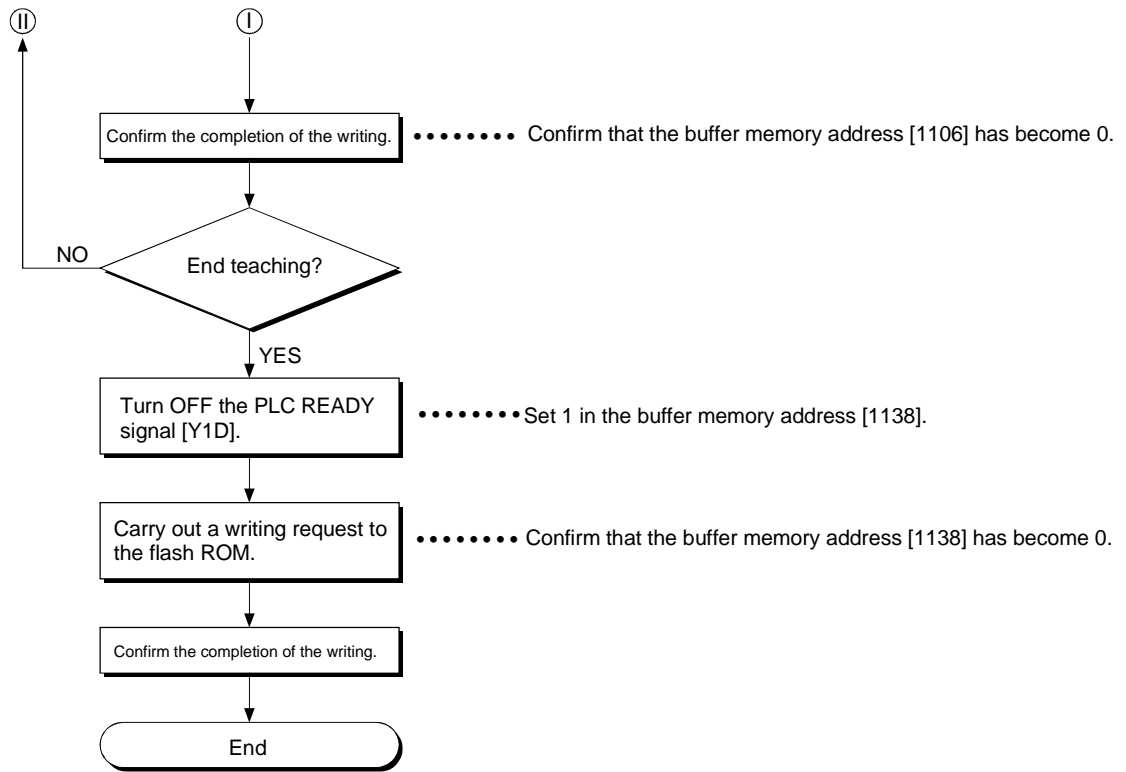

(5) Teaching program example

The following shows a sequence program example for setting (writing) the positioning data obtained with the teaching function to the AD75.

(a) Setting conditions

- When setting the current feed value as the positioning address/arc auxiliary point, write it when the BUSY signal is OFF.

(b) Program example 1

- The following example shows a program in which the "[Md.29] Current feed value" is written to the "positioning address" of the axis 1 positioning data No. 1, and the positioning data stored in D40 to D45 is written to the other positioning data.

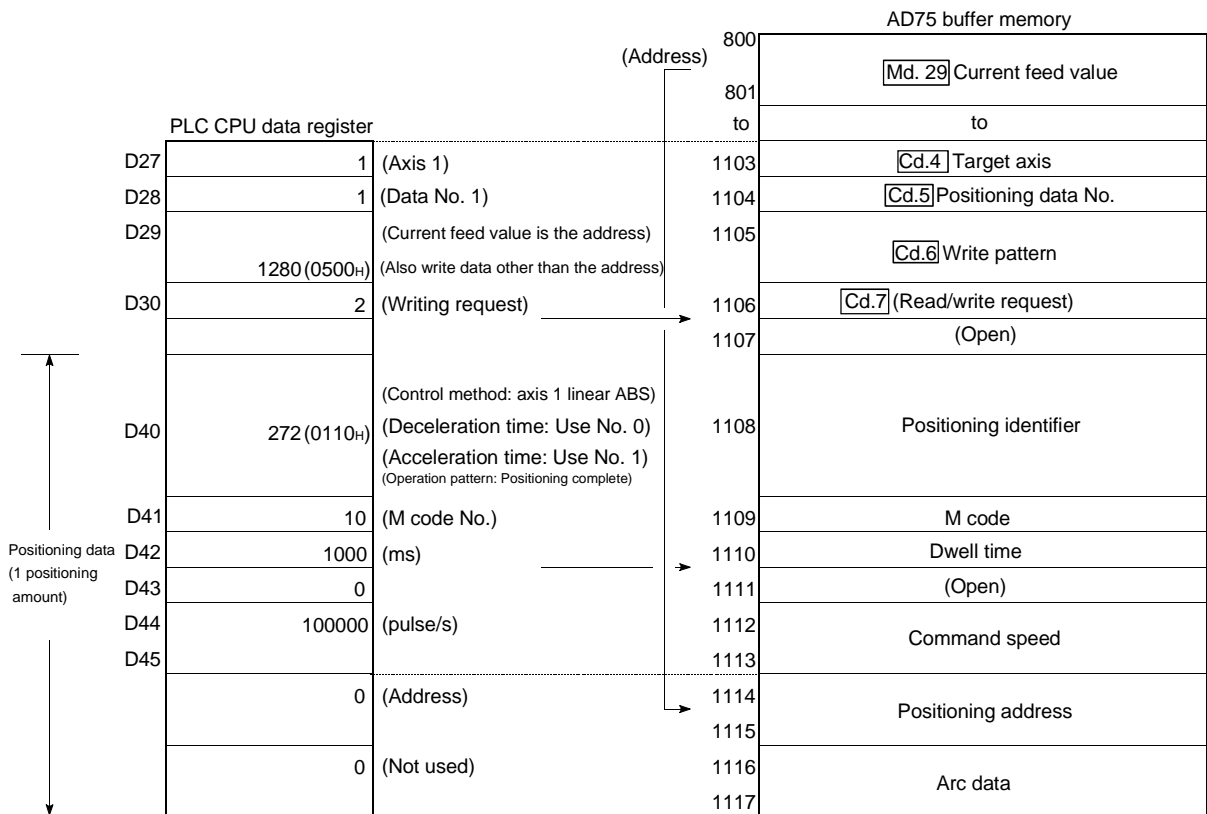

- 1) Move the workpiece to the target position using a JOG operation (or a manual pulse generator operation).

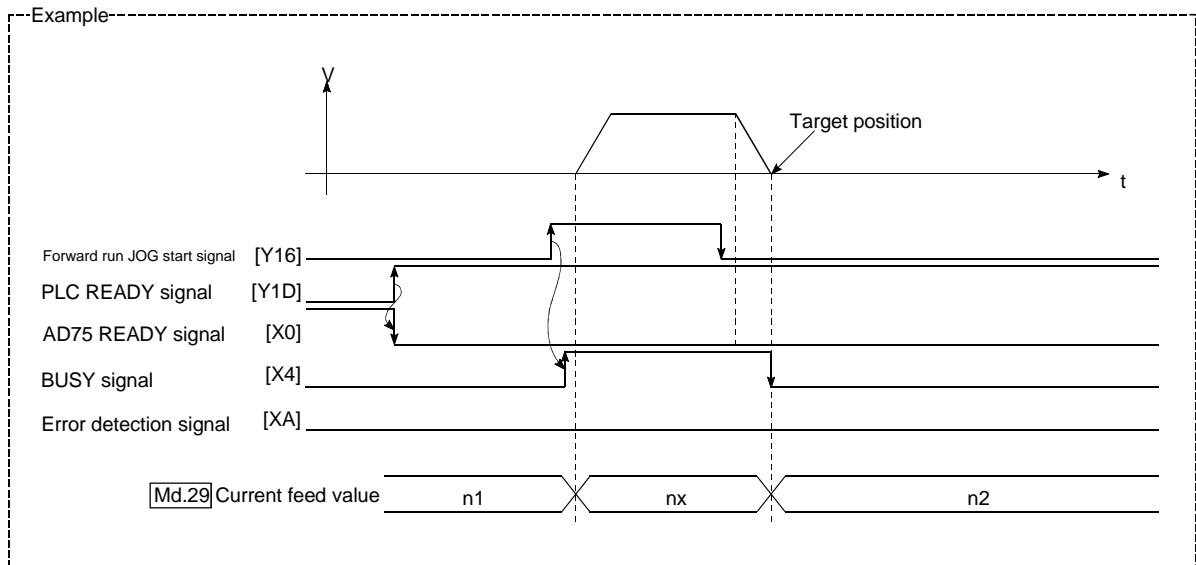

2) Carry out the teaching operation with the following program.

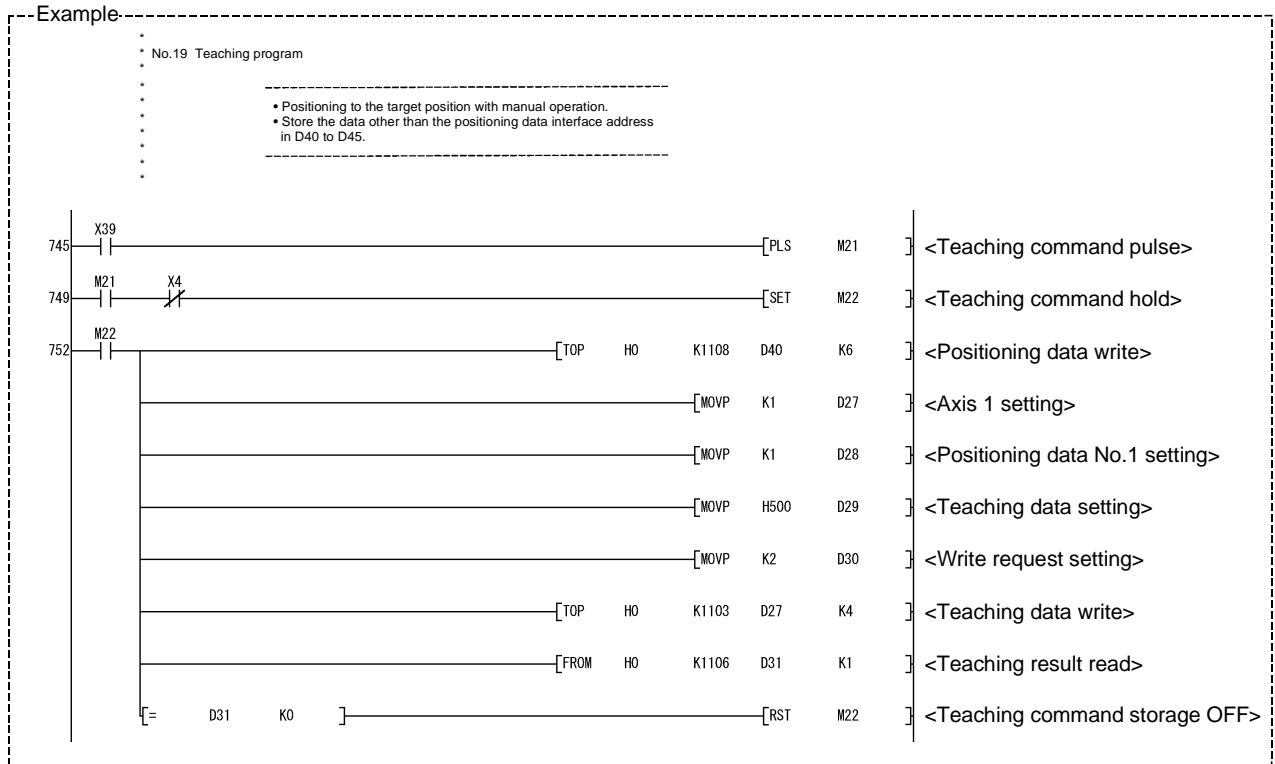

POINT

- (1) Use the address 1103 to 1137 areas in the system control data area as the buffer memory for the positioning data interface.
- (2) Confirm the teaching function and teaching procedure before setting the positioning data.
- (3) The positioning addresses that are written are absolute address (ABS) values.
- (4) If the positioning operation is correctly completed with the written positioning data, it is recommended that the positioning data be registered in the AD75 flash ROM.

(c) Program example 2

- The following example shows a program in which the "Md.29 Current feed value" is written to the "positioning address" and "arc address" of the circular interpolation control positioning data No. 2 of axis 1 and axis 2.

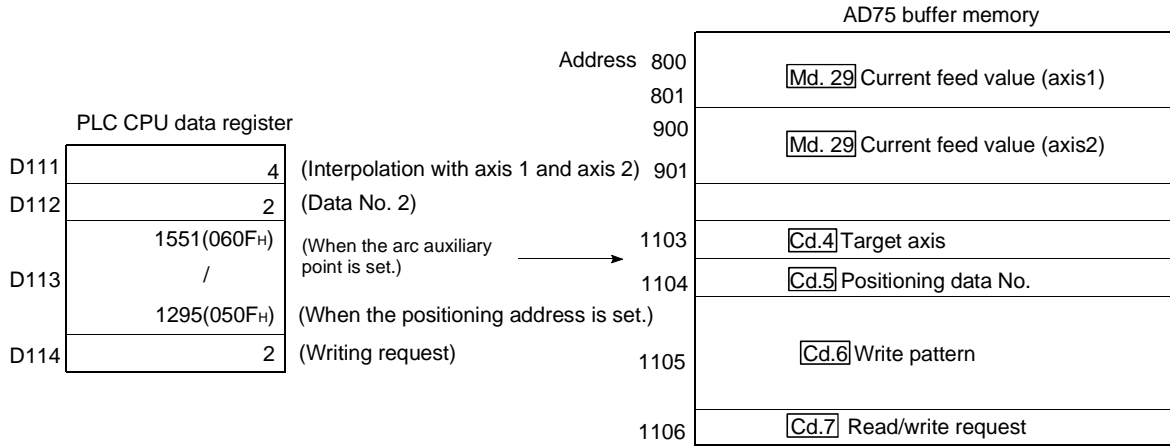

- Move the workpiece to the target position using a JOG operation (or a manual pulse generator operation).

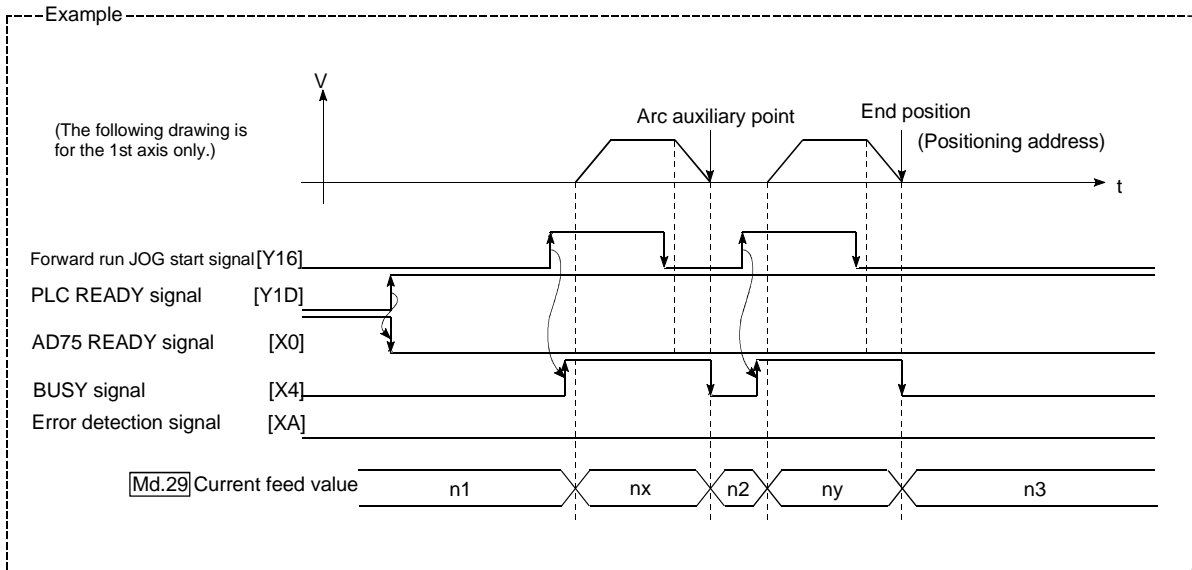

2) Carry out the teaching operation with the following program.

Example

Teaching program

- Set the positioning data other than the positioning address and circle data of data No. 2.
- Position the workpiece to the auxiliary point of the circular interpolation using a manual operation.
- Store the data for the positioning data interface in D111 to D114. (Write pattern: 060FH)

PLS M105] <Teaching command 1 pulse>

TOP HO K1103 D111 K4] <Interface data setting>

SET M106] <Teaching command 1 hold>

FROM HO K1106 D115 K1] <Teaching result (auxiliary point) read>

[= D115 K0]] <Teaching command 1 storage OFF>

[= D115 K0]]

- Position the workpiece to the end (positioning address) of the circular interpolation using a manual operation.
- Store the data for the positioning data interface in D111 to D114. (Write pattern: 050FH)

PLS M107] <Teaching command 2 pulse>

TOP HO K1103 D111 K4] <Interface data setting>

SET M108] <Teaching command 2 hold>

FROM HO K1106 D116 K1] <Teaching result (end point) read>

[= D116 K0]] <Teaching command 2 storage OFF>

[= D116 K0]]

X4 : BUSY signal
 X40, X41 : Teaching 1, 2 command
 M105, M107 : Teaching command 1, 2 pulse
 M106, M108 : Teaching command 1, 2 storage
 D111 to D114 : Positioning data interface
 D115, D116 : Teaching results

POINT
(1) Use the address 1103 to 1137 areas in the system control data area as the buffer memory for the positioning data interface.
(2) Confirm the teaching function and teaching procedure before setting the positioning data.
(3) The positioning addresses that are written are absolute address (ABS) values.
(4) If the positioning operation is correctly completed with the written positioning data, it is recommended that the positioning data be registered in the AD75 flash ROM.

12.6.5 Command in-position function

The "command in-position function" checks the remaining distance to the stop position during the automatic deceleration of positioning control, and set a flag. This flag is called the "command in-position flag". The command in-position flag is used as a front-loading signal indicating beforehand the completion of the position control.

The details shown below explain about the "command in-position function".

- (1) Control details
- (2) Precautions during control
- (3) Setting the command in-position function
- (4) Confirming the command in-position flag

(1) Control details

The following shows control details of the command in-position function.

- (a) When the remaining distance to the stop position during the automatic deceleration of positioning control becomes equal to or less than the value set in "[Pr.17] Command in-position width", "1" is stored in the command in-position flag ([Md.40] Status: b2).

(Command in-position width check)

$$\text{Remaining distance} \leq \text{[Pr.17] Command in-position width setting value}$$

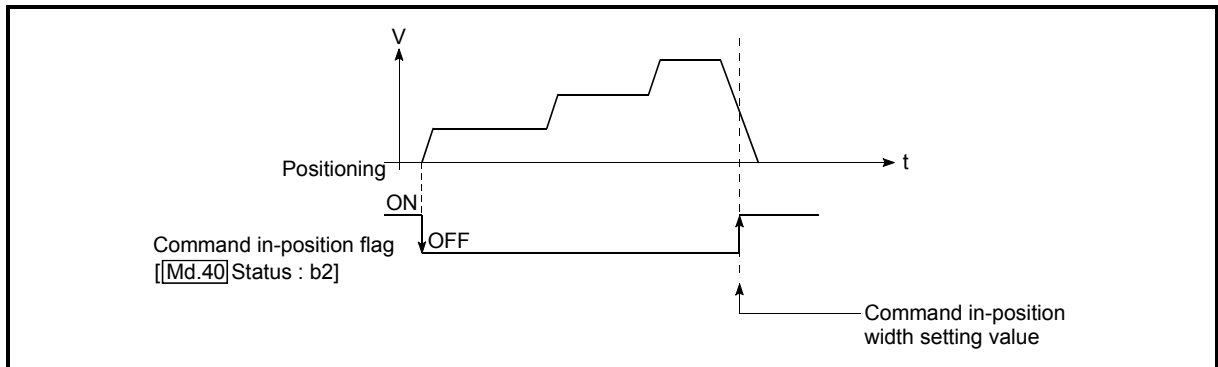

Fig. 12.37 Command in-position operation

- (b) A command in-position width check is carried out every 56.8ms.

(2) Precautions during control

- (a) A command in-position width check will not be carried out during speed control or controlling speed of speed/position changeover control.

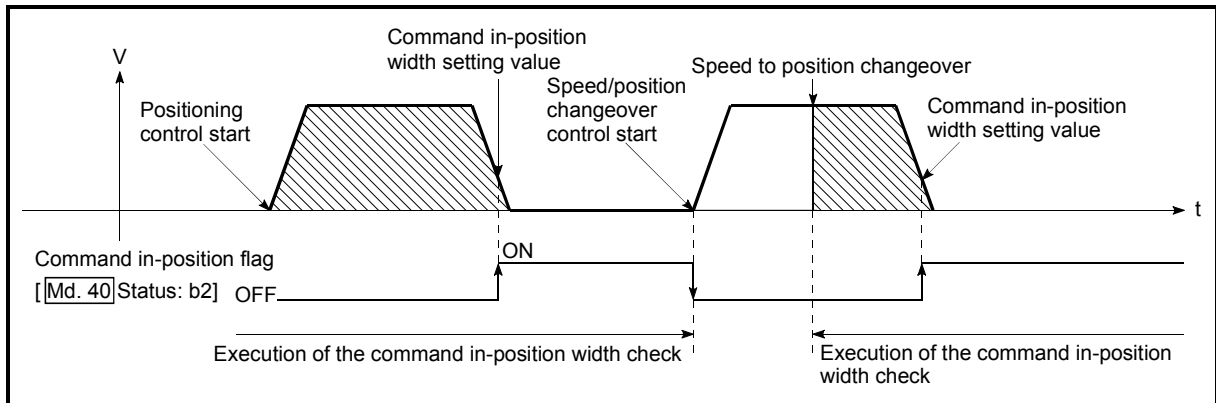

Fig. 12.38 Command in-position width check

- (b) The command in-position flag will be turned OFF in the following cases. ("0" will be stored in "[Md.40] Status: b2".)
- At the positioning control start
 - At the speed control start
 - At the zero point return control start
 - At the JOG operation start
 - When the manual pulse generator operation is enabled.
- (c) The "[Pr.17] Command in-position width" and command in-position flag ([Md.40] Status: b2) of the reference axis are used during interpolation control.

(3) Setting the command in-position function

To use the "command in-position function", set the required value in the parameter shown in the following table, and write it to the AD75.

The set details are validated at the rising edge (OFF → ON) of the PLC READY signal (Y1D).

Setting item	Setting value	Setting details	Factory-set initial value	
Pr.17	Command in-position width	→	Turn ON the command in-position flag, and set the remaining distance to the stop position of the position control.	100

* Refer to section "5.2 List of parameters" for setting details.

(4) Confirming the command in-position flag

The "command in-position flag" is stored in the following buffer memory.

Monitor item	Monitor value	Storage details	Buffer memory address			
			Axis 1	Axis 2	Axis 3	
Md.40	Status	→	The command in-position flag is stored in the "b2" position.	817	917	1017

* Refer to section "5.6 List of monitor data" for information on the storage details.

REMARK

- Parameters are set for each axis.
- It is recommended that the parameters be set whenever possible with the AD75 software package. Execution by sequence program uses many sequence programs and devices. The execution becomes complicated, and the scan times will increase.

12.6.6 Stepping motor mode function

The "stepping motor mode function" is used to carry out the settings when controlling a stepping motor with the AD75. By setting the "stepping motor mode function", "step out prevention during acceleration/deceleration", "reduction of mechanical vibration due to decreases in frequency fluctuations", etc., will be carried out, and control of the stepping motor with the AD75 will be enabled.

The details shown below explain about the "stepping motor mode function".

- (1) Precautions during control
- (2) Setting the stepping motor mode function

(1) Precautions during control

Control the axis set to the stepping motor control mode within the following restrictions.

(a) Restrictions on position command range and speed command range

In the stepping motor mode, the position command range and speed command range are 1/16 of those in standard motors.

When using the stepping motor mode, carry out control within the setting range of the mode.

(b) Circular interpolation control use is not possible

Circular interpolation cannot be designated in the stepping motor mode. (Circular interpolation control is also not possible when using a servomotor in the stepping motor mode.)

An error "control method setting error" (error code: 524) will occur if circular interpolation is started when the stepping motor mode is set.

(c) S-curve acceleration/deceleration use is not possible

"S-curve acceleration/deceleration" cannot be carried out in the stepping motor mode. Step out may occur if this is used.

(d) Restrictions on linear interpolation control

Use the linear interpolation control with both axes set to the standard mode or the stepping motor mode.

Control at the command speed is not possible when the stepping motor mode and the standard mode are used in combination in linear interpolation control.

When carrying out linear interpolation control of a stepping motor and servomotor, set both axes to the stepping motor mode.

(e) Restrictions during continuous path control

- Continuous path control can only be used in the control of 1 axis at a time. Continuous path control cannot be used in 2-axis interpolation control. Positioning deviation may occur if continuous path control is used in 2-axis interpolation control.
- Continuous path control can only be used in control in the same direction. The positioning will deviate if continuous path control is used in control in which the direction reverses. Use continuous positioning control when carrying out control in which the direction reverses in the stepping motor mode.

(f) Restrictions on INC commands

Do not use an INC command to carry out positioning in the reverse direction after a JOG operation stop or positioning stop. If positioning in the reverse direction is carried out by INC command after JOG operation stop or positioning stop, it may be positioned 1 pulse more than the command pulses.

(g) Restrictions on electronic gears

Vibration may occur if the "movement amount per pulse" value is small in the stepping motor mode. The use of a 1/1 ratio "movement amount per pulse" value is recommended.

(h) Standard motor and stepping motor mode changeover control is not possible

The position command range and speed command range differ between the stepping motor mode and standard mode. Because of this, it is not possible to use the stepping motor mode and standard mode by changing over between them. Normal control cannot be carried out when using the stepping motor mode and standard mode after changing over between them.

(i) Restrictions on speed

When the stepping motor mode is used, the operation may be controlled at a low speed of 20 pulses/second in respect to the set positioning speed.

(2) Setting the stepping motor mode function

To use the "stepping motor mode function", set the required values in the parameters shown in the following table, and write them to the AD75.

The set details are validated at the rising edge (OFF → ON) of the PLC READY signal (Y1D).

Setting item	Setting value	Setting details	Factory-set initial value
Pr.10	Bias speed at start	→ Set the minimum speed during start.	0
Pr.11	Stepping motor mode selection	1 Set "1: stepping motor mode".	0

* Refer to section "5.2 List of parameters" for setting details.

REMARK

- Parameters are set for each axis.
- It is recommended that the parameters be set whenever possible with the AD75 software package. Execution by sequence program uses many sequence programs and devices. The execution becomes complicated, and the scan times will increase.

12.6.7 Acceleration/deceleration processing function

The "acceleration/deceleration processing function" adjusts the acceleration/deceleration when each control is executed.

Adjusting the acceleration/deceleration processing to match the control enables more precise control to be carried out.

There are three acceleration/deceleration adjustment items that can be set: "Acceleration/deceleration time size selection", "acceleration/deceleration time 0 to 3", and "acceleration/deceleration method setting".

The details shown below explain about the "acceleration/deceleration processing function".

- (1) "Acceleration/deceleration time size selection" control details and setting
- (2) "Acceleration/deceleration time 0 to 3" control details and setting
- (3) "Acceleration/deceleration method setting" control details and setting

(1) "Acceleration/deceleration time size selection" control details and setting

In the "acceleration/deceleration time size selection", the sizes (setting ranges) of the acceleration time, deceleration time, and sudden stop deceleration time are selected and set.

- Acceleration time: The time from speed 0 until the "[Pr.7] Speed limit value" is reached.
- Deceleration time: The time from the "[Pr.7] Speed limit value" until speed 0 is reached.
- Sudden stop deceleration time: The time from "[Pr.7] Speed limit value" until speed 0 is reached.

Set the required values for the acceleration/deceleration time size in the parameters shown in the following table, and write them to the AD75.

The set details are validated at the rising edge (OFF → ON) of the PLC READY signal (Y1D).

Setting item		Setting value	Setting details	Factory-set initial value
[Pr.25]	Size selection for acceleration/deceleration time	→	Select the acceleration/deceleration time size (setting range) from the following two sizes, and set the appropriate value. 0: 1 to 65535ms 1: 1 to 8388608ms	0

* Refer to section "5.2 List of parameters" for setting details.

- (2) "Acceleration/deceleration time 0 to 3" control details and setting
- In the AD75, four types each of acceleration time and deceleration time can be set. By using separate acceleration/deceleration times, control can be carried out with different acceleration/deceleration times for positioning control, JOG operation, zero point returns, etc.
- Set the required values for the acceleration/deceleration time in the parameters shown in the following table, and write them to the AD75.
- The set details are validated when written to the AD75.

Setting item	Setting value	Setting details	Factory-set initial value
Pr.8	Acceleration time 0	→	1000
Pr.26	Acceleration time 1	→	Set the acceleration time within the setting value range set in "[Pr.25] Size selection for acceleration/deceleration time".
Pr.27	Acceleration time 2	→	
Pr.28	Acceleration time 3	→	
Pr.9	Deceleration time 0	→	
Pr.29	Deceleration time 1	→	Set the deceleration time within the setting value range set in "[Pr.25] Size selection for acceleration/deceleration time".
Pr.30	Deceleration time 2	→	
Pr.31	Deceleration time 3	→	

* Refer to section "5.2 List of parameters" for setting details.

- (3) "Acceleration/deceleration method setting" control details and setting

In the "acceleration/deceleration method setting", the acceleration/deceleration processing method is selected and set. The set acceleration/deceleration processing is applied to all acceleration/deceleration.

The two types of "acceleration/deceleration method setting" are shown below.

- (a) Automatic trapezoidal acceleration/deceleration processing method

This is a method in which linear acceleration/deceleration is carried out based on the acceleration time, deceleration time, and speed limit value set by the user.

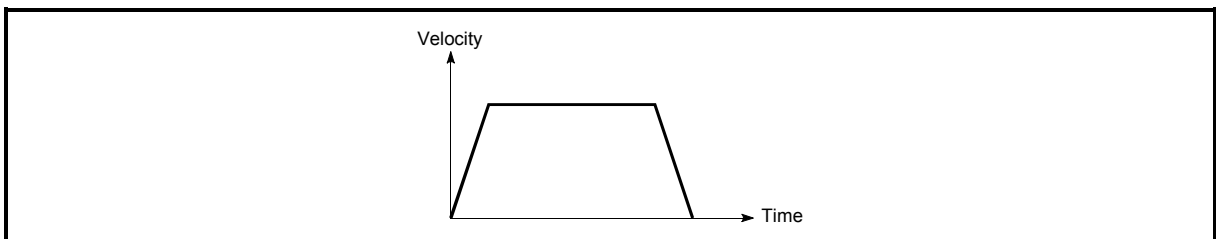

Fig. 12.39 Automatic trapezoidal acceleration/deceleration processing method

(b) S-curve acceleration/deceleration processing method

In this method, the motor burden is reduced during starting and stopping. This is a method in which acceleration/deceleration is carried out gradually, based on the acceleration time, deceleration time, speed limit value, and "Pr.36 S-curve ratio" (1 to 100%) set by the user.

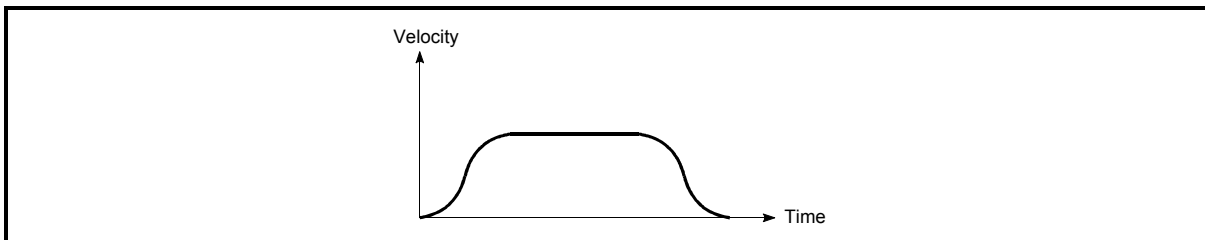

Fig. 12.40 S-curve acceleration/deceleration processing method

When a speed change request is given during S-curve acceleration/deceleration processing, S-curve acceleration/deceleration processing begins at a speed change request start.

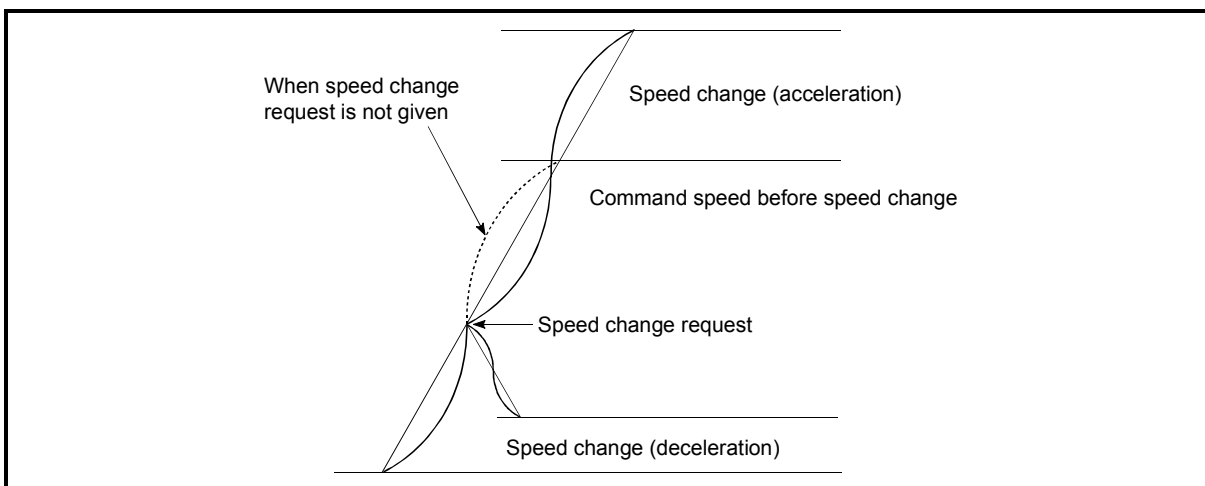

Fig. 12.41 Speed change during S-curve acceleration/deceleration processing

Set the required values for the "acceleration/deceleration method setting" in the parameters shown in the following table, and write them to the AD75. The set details are validated when written to the AD75.

Setting item		Setting value	Setting details	Factory-set initial value
Pr.35	Acceleration/deceleration process selection	→	Set the acceleration/deceleration method. 0: Automatic trapezoidal acceleration/deceleration method 1: S-curve acceleration/deceleration processing	0
Pr.36	S-curve ratio	→	Set the acceleration/deceleration curve when "1" is set in "Pr.35 Acceleration/deceleration processing selection".	100

* Refer to section "5.2 List of parameters" for setting details.

REMARK

- Parameters are set for each axis.
 - It is recommended that the parameters be set whenever possible with the AD75 software package. Execution by sequence program uses many sequence programs and devices. The execution becomes complicated, and the scan times will increase.

12.6.8 Indirectly specification function

The "indirectly specification function" specifies indirectly and starts the positioning data No.

The "indirectly specification function" is executed by setting the positioning data No. 1 to 600 desired to be started to the "indirectly specification data area" and starting that "indirectly specification data".

The "indirectly specification data" can be set on an "indirectly specification No. (8001 to 8050)" basis and can be set to up to 50 pieces on an axis basis.

The following details will be explained about the "indirectly specification function".

- (1) "Indirectly specification data" setting items and setting details
- (2) "Indirectly specification data" configuration
- (3) Control details and setting

(1) "Indirectly specification data" setting items and setting details

The following indicates the outline of the setting items and setting details of the "indirectly specification data" to be stored into the AD75.

Setting item		Setting details
Indirectly specification data	Positioning data No. for indirectly specification No. 8001	Set the positioning data No. (1 to 600) whose execution will be started when 8001 is set as the positioning start No. and started.
	Positioning data No. for indirectly specification No. 8002	Set the positioning data No. (1 to 600) whose execution will be started when 8002 is set as the positioning start No. and started.
	Positioning data No. for indirectly specification No. 8003	Set the positioning data No. (1 to 600) whose execution will be started when 8003 is set as the positioning start No. and started.
	Positioning data No. for indirectly specification No. 8004	Set the positioning data No. (1 to 600) whose execution will be started when 8004 is set as the positioning start No. and started.
	Positioning data No. for indirectly specification No. 8005	Set the positioning data No. (1 to 600) whose execution will be started when 8005 is set as the positioning start No. and started.
	to	to
	Positioning data No. for indirectly specification No. 8046	Set the positioning data No. (1 to 600) whose execution will be started when 8046 is set as the positioning start No. and started.
	Positioning data No. for indirectly specification No. 8047	Set the positioning data No. (1 to 600) whose execution will be started when 8047 is set as the positioning start No. and started.
	Positioning data No. for indirectly specification No. 8048	Set the positioning data No. (1 to 600) whose execution will be started when 8048 is set as the positioning start No. and started.
	Positioning data No. for indirectly specification No. 8049	Set the positioning data No. (1 to 600) whose execution will be started when 8049 is set as the positioning start No. and started.
	Positioning data No. for indirectly specification No. 8050	Set the positioning data No. (1 to 600) whose execution will be started when 8050 is set as the positioning start No. and started.

(2) "Indirectly specification data" configuration

The following AD75 buffer memory can store the "indirectly specification data (positioning data No. 1 to 600)" corresponding to the "indirectly specification No. (8001 to 8050)" on an axis basis.

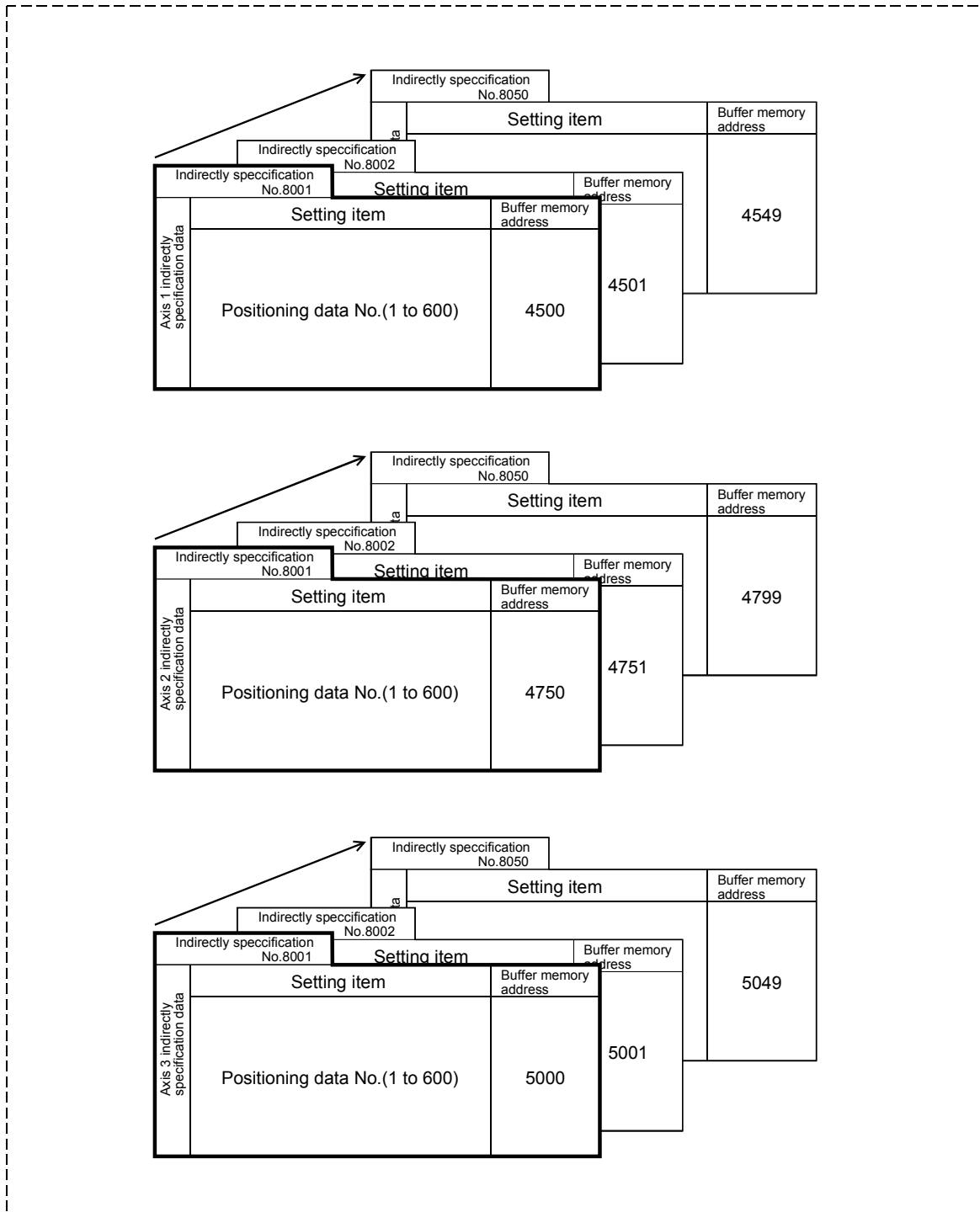

* Set to the AD75 using a sequence program or the AD75 software package.

(3) Control details and setting

The following shows the control details and setting when the indirectly specification data set to the indirectly specification No. 8001 of axis 1 is started.

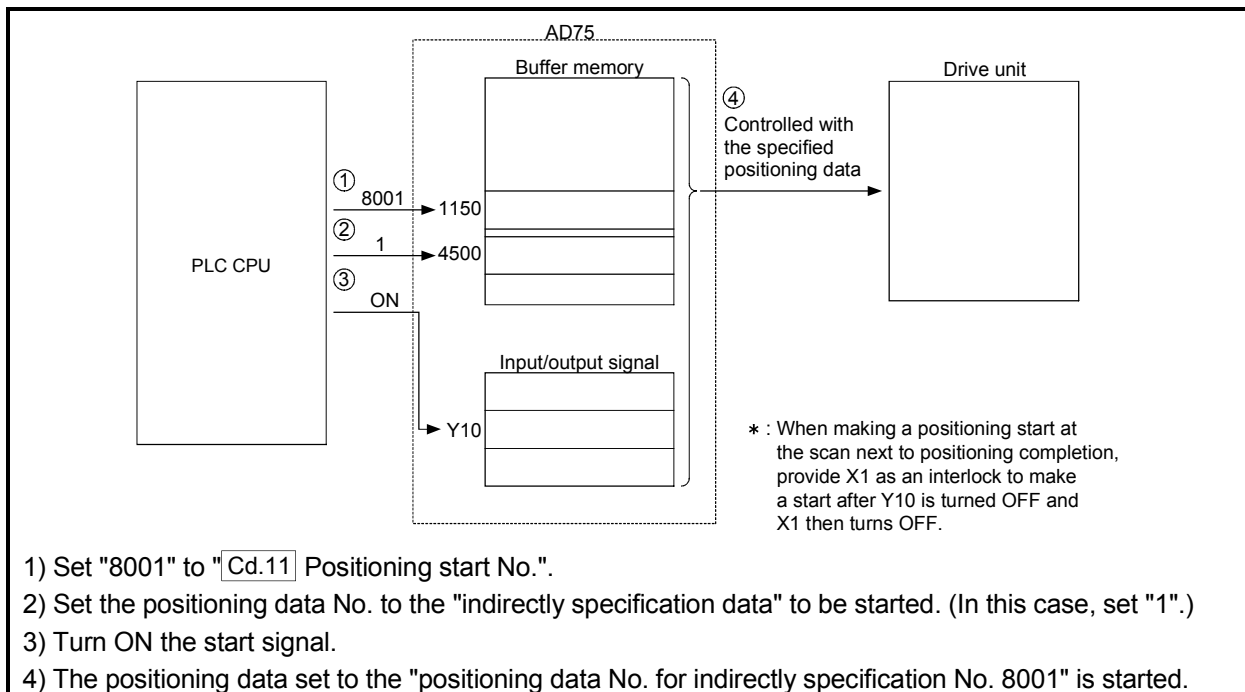

Fig. 12.42 Indirectly specification function operating procedure (for axis 1)

(1) Control data that requires setting

The following control data must be set to execute the indirectly specification function. Make this setting using a sequence program.

Setting item	Setting value	Setting details	Buffer memory address		
			Axis 1	Axis 2	Axis 3
Cd.11	Positioning start No.	8001	Set "8001" that indicates the control using the "indirectly specification data".		
			1150	1200	1250

* For the setting details, refer to section "5.7 List of control data".

(2) Starting conditions

The following conditions must be satisfied to make a start. Also, the required conditions must be incorporated into the sequence program, and the data must be disabled from starting if the conditions are not satisfied.

Signal name	Signal state	Device			
		Axis 1	Axis 2	Axis 3	
Interface signal	PLC READY signal	ON	PLC CPU preparation completed		
	AD75 READY signal	OFF	AD75 preparation completed		
	Axis stop signal	OFF	Y13	Y14	Y1C
	Start complete signal	OFF	X1	X2	X3
	BUSY signal	OFF	X4	X5	X6
	Error detection signal	OFF	XA	XB	XC
	M code ON signal	OFF	XD	XE	XF
External signal	Drive unit READY signal	ON	Drive unit preparation completed		
	Stop signal	OFF	Stop signal is OFF		
	Upper limit (FLS)	ON	Within limit range		
	Lower limit (RLS)	ON	Within limit range		

(3) Start time chart

The following time chart assumes that the positioning data No. 1, 2, 3, 4 and 5 of axis 1 are executed consecutively by "indirectly specification" as an example.

(a) Indirectly specification data setting example

Axis 1 indirectly specification No.	Positioning data No. for indirectly specification No. 8001 for axis 1
8001	1

(b) Positioning data setting example

Axis 1 positioning data No.	Da.1 Operation pattern
1	11: Continuous path control
2	01: Continuous positioning control
3	11: Continuous path control
4	11: Continuous path control
5	00: Positioning complete

(c) Start time chart

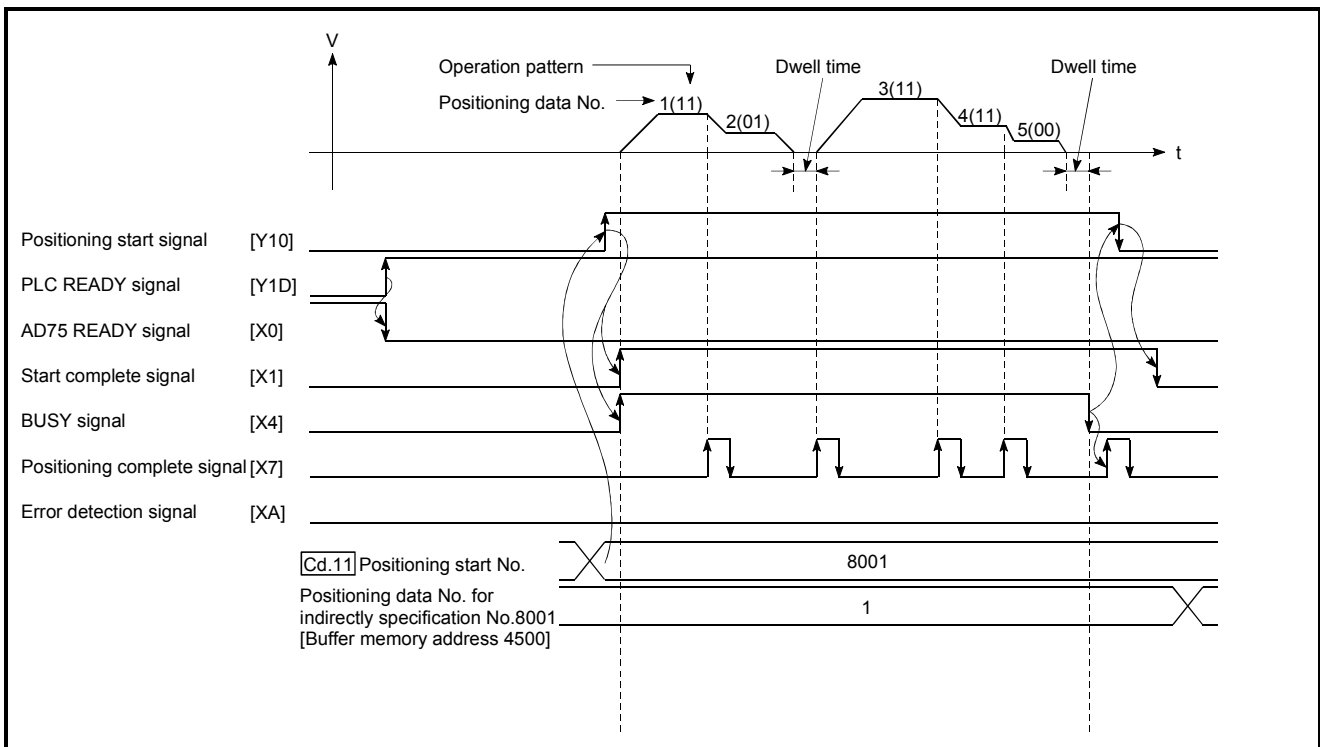

Fig. 12.43 Start time chart for positioning control using indirectly specification function

Chapter 13

COMMON FUNCTIONS

The details and usage of the "common functions" executed according to the user's requirements are explained in this chapter.

Common functions include functions required when using the AD75, such as parameter initialization and execution data backup.

Read the setting and execution procedures for each common function thoroughly, and execute the appropriate function where required.

13.1	Outline of common functions.....	13- 2
13.2	Parameter initialization function	13- 3
13.3	Execution data backup function	13- 5
13.4	LED display function	13- 7
13.5	Clock data function	13- 11

13.1 Outline of common functions

"Common functions" are executed according to the user's requirements, regardless of the control method, etc.

Common functions include "parameter initialization", "execution data backup", "work status and error code display", etc. These common functions are executed by commands from the AD75 software package, common function sequence programs, mode switches on the front panel of the main unit, etc.

The following table shows the functions included in the "common functions".

Common function	Details
Parameter initialization function	This function returns the "setting data" stored in the AD75 flash ROM to the factory-set initial value. There are two methods for this function. 1) Method using the sequence program 2) Method using the AD75 software package
Execution data backup function	This function stores (backs up) the "setting data", currently being executed, in the flash ROM. There are two methods for this function. 1) Method using the sequence program 2) Method using the AD75 software package
LED display function	This function displays the AD75 work status, signal status, error details, etc., on the 17-segment LED on the front of the main unit. The display details are changed over using the mode switch on the front of the main unit.
Clock data function	This function sets the PLC CPU clock data in the AD75. This is used for various history data, etc.

13.2 Parameter initialization function

"The parameter initialization function" is used to return the setting data set in the AD75 flash ROM and OS memory to their factory-set initial values.

This function is used when several parameter errors occur and the AD75 will not start. In this case, resetting is carried out after the setting data are initialized. (If there is an abnormality in the parameters set in the AD75 when the PLC READY signal (Y1D) is turned ON, the AD75 READY signal (X0) will not turn OFF, and control will not be possible.)

Parameter initialization is carried out using one of the following methods.

- Method using the sequence program.
- Method using the AD75 software package.

"The execution method using the sequence program" is explained in this section. Refer to the AD75 Software Package Operating Manual for details on the execution method using the AD75 software package.

The details shown below explain about the "parameter initialization function".

- (1) Control details
- (2) Precautions during control
- (3) Initializing the parameters

(1) Control details

The following table shows the setting data initialized by the "parameter initialization function".

(Initialized are "flash ROM" and "OS memory" following data.)

Setting data
Basic parameters (Pr.1 to Pr.11)
Detailed parameters (Pr.12 to Pr.44)
Zero point return basic parameters (Pr.45 to Pr.50)
Zero point return detailed parameters (Pr.51 to Pr.58)
Positioning data
Start block data
Condition data

(2) Precautions during control

- (a) Parameter initialization is only executed when the PLC READY signal (Y1D) is OFF.
(A warning "In PLC READY" (warning code: 111) will occur if executed when the PLC READY signal (Y1D) is ON.)
- (b) A "PLC CPU reset" or "PLC power restart" must be carried out after the parameters are initialized. (Parameter initialization is carried out for the AD75 "flash ROM" and "OS memory". Data stored in the "buffer memory" will not be initialized.)
- (c) The flash ROM can be written up to 100,000 times. The flash ROM cannot be written after 100,000 writing cycles.

Important

Parameter initialization takes about 10 seconds. (Up to 30 seconds are sometimes required.)

Do not turn the power ON/OFF; reset the PLC CPU, etc., during parameter initialization. The flash ROM data may be corrupted.

(3) Initializing the parameters

To use the "parameter initialization function", set the data shown in the following table, and write it to the AD75 using the sequence program.

Parameter initialization is carried out when the data is written to the AD75.

Setting item	Setting value	Setting details	Buffer memory address		
			Axis 1	Axis 2	Axis 3
Cd.10 Parameter initialization request	1	Set "1" (parameter initialization request).	1139		

* Refer to section "5.7 List of control data" for details on the setting details.

When the initialization is complete, "0" will be set in "**Cd.10** Parameter initialization request" by the AD75.

13.3 Execution data backup function

When the AD75 buffer memory data is rewritten from the PLC CPU, "the data backed up in the AD75 flash ROM" may differ from "the data for which control is being executed". In cases like these, the data being executed will be lost when the PLC power is turned OFF. (Refer to Chapter 7.)

In cases like these, the "execution data backup function" backs up the data being executed by writing it to the flash ROM. The data that was backed up is then written to the buffer memory when the power is turned ON next.

The execution data is backed up (written to the flash ROM) using one of the following methods.

- Method using the sequence program
- Method using the AD75 software package

"The execution method using the sequence program" is explained in this section. Refer to the AD75 Software Package Operating Manual for details on the execution method using the AD75 software package.

The details shown below explain about the "execution data backup function".

- (1) Control details
- (2) Precautions during control
- (3) Backing up the execution data

(1) Control details

The following shows the data that can be written to the flash ROM using the "execution data backup function".

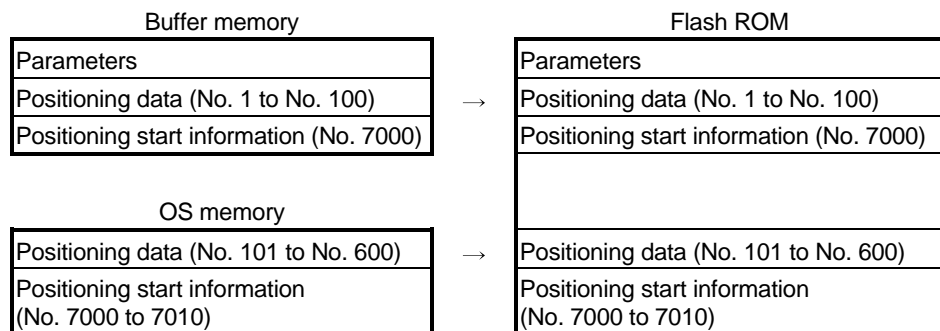

(2) Precautions during control

- (1) Data can only be written to the flash ROM when the PLC READY signal (Y1D) is OFF.
- (2) Writing to the flash ROM can be executed up to 100,000 times. (Writing to the flash ROM will become impossible after 100,000 times.)

Important	Do not turn the power ON/OFF; reset the PLC CPU, etc., during parameter writing. The flash ROM data may be corrupted.
------------------	---

(3) Backing up the execution data

To use the "execution data backup function", set the data shown in the following table, and write it to the AD75 using the sequence program.

The writing to the flash ROM is carried out when the data is written to the AD75.

Setting item	Setting value	Setting details	Buffer memory address		
			Axis 1	Axis 2	Axis 3
Cd.9 Flash ROM write request	1	Set "1" (flash ROM write request).	1138		

* Refer to section "5.7 List of control data" for details on the setting details.

When the writing to the flash ROM is complete, "0" will be set in "Cd.9 Flash ROM write request" by the AD75.

13.4 LED display function

The AD75 status, control status of each axis, input/output signal status, etc., can be confirmed using the LED display on the front of the AD75 main unit. Monitor the operation condition as required when the AD75 is not operating normally, etc. (Constant monitoring is possible.)

The details shown below explain about the "LED display function".

- (1) LED display position
- (2) Display details
- (3) Changing the display details

(1) LED display position

The various types of information are displayed on the "17-segment LED" and "axis display LED" on the front of the main unit.

The display is changed over by the "mode switch".

The following drawing shows the positions of the "17-segment LED", "axis display LED", and "mode switch".

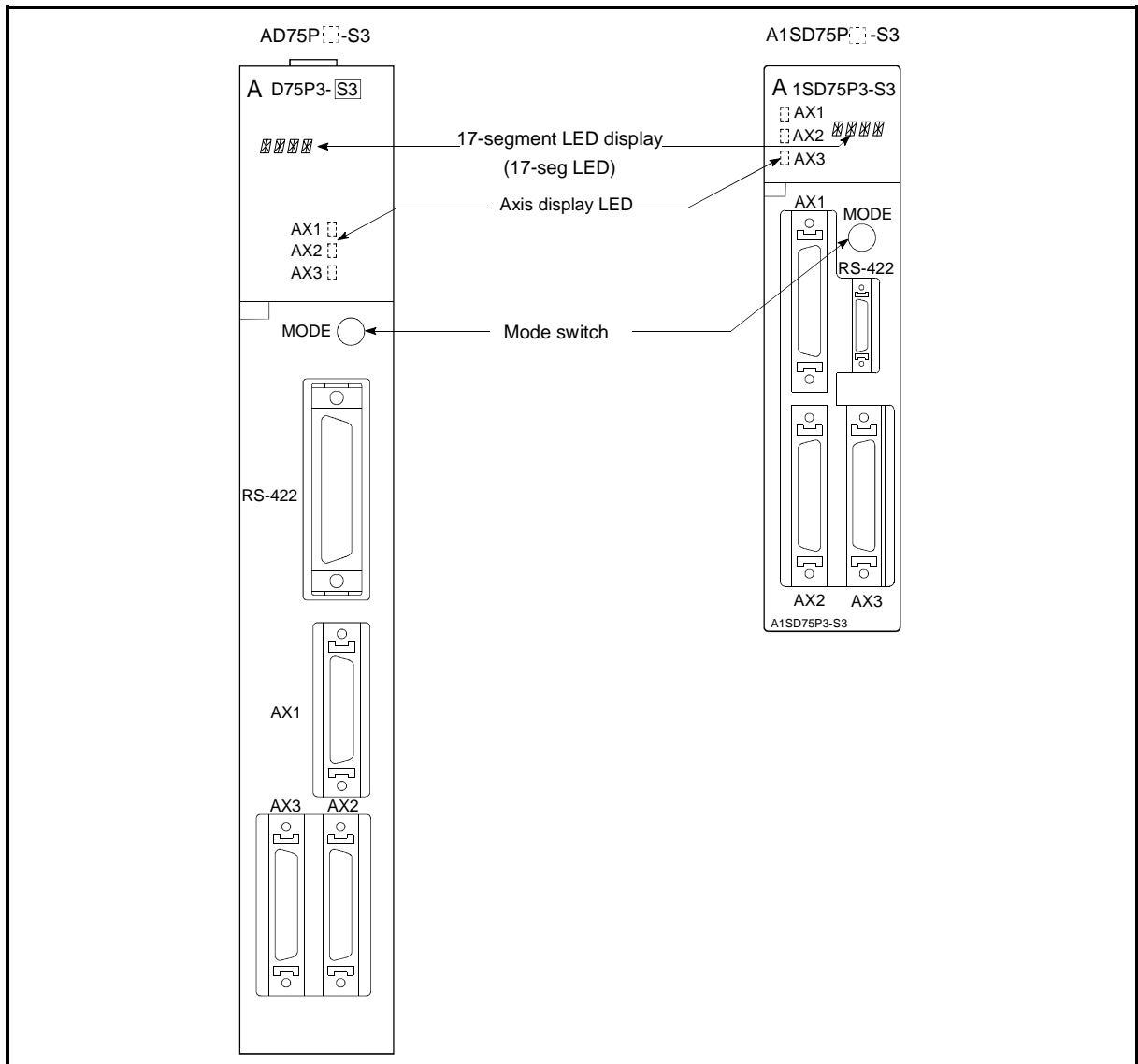

(2) Display details

The details displayed in the LED display area are classified into several types of information (called "modes"). The following types of information are displayed according to the various modes on the "17-segment LED display" and "axis display LED".

(The display is changed over by the "mode switch". Refer to section "(3) Changing the display details" for more information.)

(a) List of display details

Mode	17-segment LED display	Axis display LED
Operation monitor 1	When there is no error	
	One of the following is displayed.	
	RUN (during operation)	The display of the axis in operation is in operation blinks.
	TEST (during a test mode)	The displays of all axes are in operation blinks.
	IDL (standing by)	OFF
	When an error occurs	
	The following is displayed. Display: ERR	The LED of the axis in which the error occurred is flickering.
Operation monitor 2	The operation status is displayed for the axis whose axis display LED is lit.	The AXn display changes over every 0.5 seconds.
Internal information 1	The OS type information is displayed. Display: S003	OFF
Internal information 2	The OS version is displayed. Display: V* * *	OFF
Input/output information n	The signal name designated by the mode switch is displayed.	Lights when the selected signal is ON.
Stepping motor mode	STMM display	The stepping motor mode axis display is lit.

REMARK

The "OS type" appears in the LED display area for 1 second after the PLC power is turned ON, then the "operation monitor 1" display appears.

(b) "Operation monitor 2" display details

The axis operation status is displayed in the "operation monitor 2" mode.
The status display of each axis changes over every 0.5 seconds.

< Display >	< Details >
IDLE	Standing by
STOP	Stopped
JOG	In JOG operation
MANP	In manual pulse generator operation
OPR	In zero point return
POSI	In position control
VELO	In speed control
V- P	In speed control of speed/position changeover control
V -P	In position control of speed/position changeover control
BUSY	Waiting for conditions, etc.
E***	When an error occurs

Error No. display

When an error occurs in an axis, that error No. is displayed for 0.5 seconds before the display changes over to the next axis.

(c) "Input/output information n" display details

The status of each signal is displayed in the "input/output information n" mode.

The displayed signal is changed over in the following order every time the "mode switch" is pressed.

The "axis display LED" is lit when the displayed signal is ON.

< Display >	< Details >
SVON.....	Servo ON signal
↓	
Z-ON	Zero point signal
↓	
ULMT	Upper limit signal
↓	
LLMT	Lower limit signal
↓	
V-P	Speed/position changeover signal
↓	
DOG.....	Near-point dog signal

(d) Other display details

The following details are displayed in the 17-segment LED as error messages, regardless of the mode.

< Display >	< Details >
FALT	This error message is displayed when the flash ROM value becomes illegal. Execute initialization. The cause of the error is a hardware fault if the error message is displayed after execution of initialization.

(3) Changing the display details

The details (mode) displayed in the LED display area change over in the following order every time the "mode switch" is pressed.

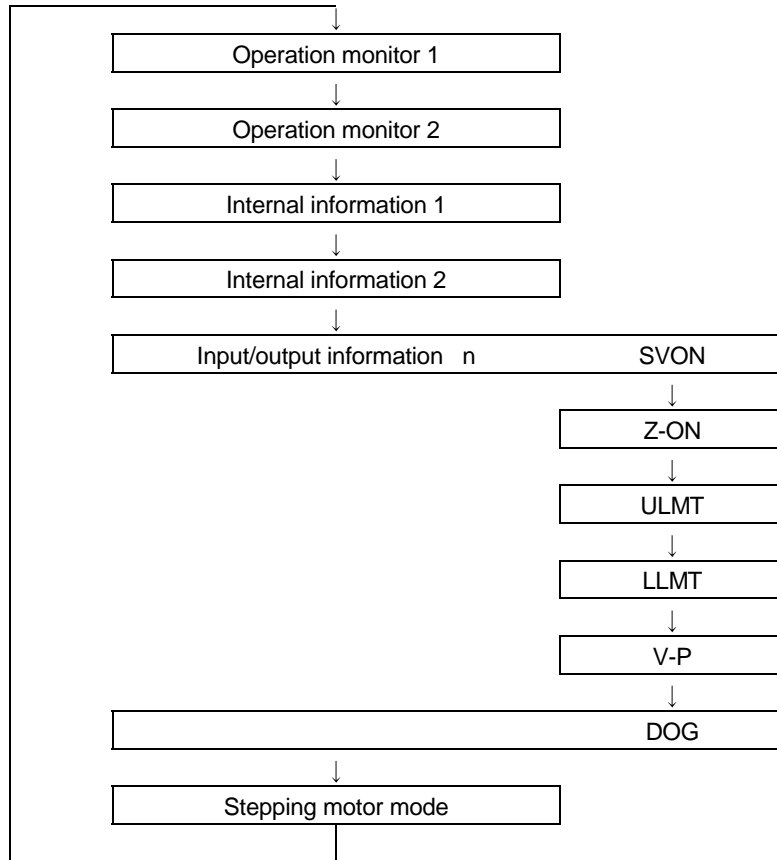

13.5 Clock data function

"The clock data function" utilizes the PLC CPU clock data in the AD75. This clock data is used to monitor the various history data. The clock data is controlled in 0.1 second units in the AD75 to simplify the measurement of cycle time, etc.

The details shown below explain about the "clock data setting function".

- (1) Precautions during control
- (2) Setting the clock data

(1) Precautions during control

- (a) Set the clock data every time the PLC CPU is started. If the clock data is not set, counting will begin as "00 hours 00 minute 00 seconds" when the AD75 starts.
- (b) The AD75 clock data count value is less accurate than the PLC CPU clock data. Therefore, synchronize it with the PLC CPU clock data about once a day.
- (c) Data indicating the "date" in the PLC CPU clock data will be ignored.

(2) Setting the clock data

The following shows the setting data and sequence program example for reading the PLC CPU clock data and setting it in the AD75.

- (a) Set the following data.

(The setting is carried out using the sequence program shown in section (b) on the next page.)

Setting item		Setting value	Setting details	Buffer memory address		
				Axis 1	Axis 2	Axis 3
Cd.1	Clock data setting (hour)	→	Set the PLC CPU clock data (hours).	1100		
Cd.2	Clock data setting (minute, second)	→	Set the PLC CPU clock data (minutes, seconds).	1101		
Cd.3	Clock data writing	1	Set "1" (clock data write request).	1102		

* Refer to section "5.7 List of control data" for details on the setting details.

(b) Add the following sequence program to the control program, and write it to the PLC CPU.

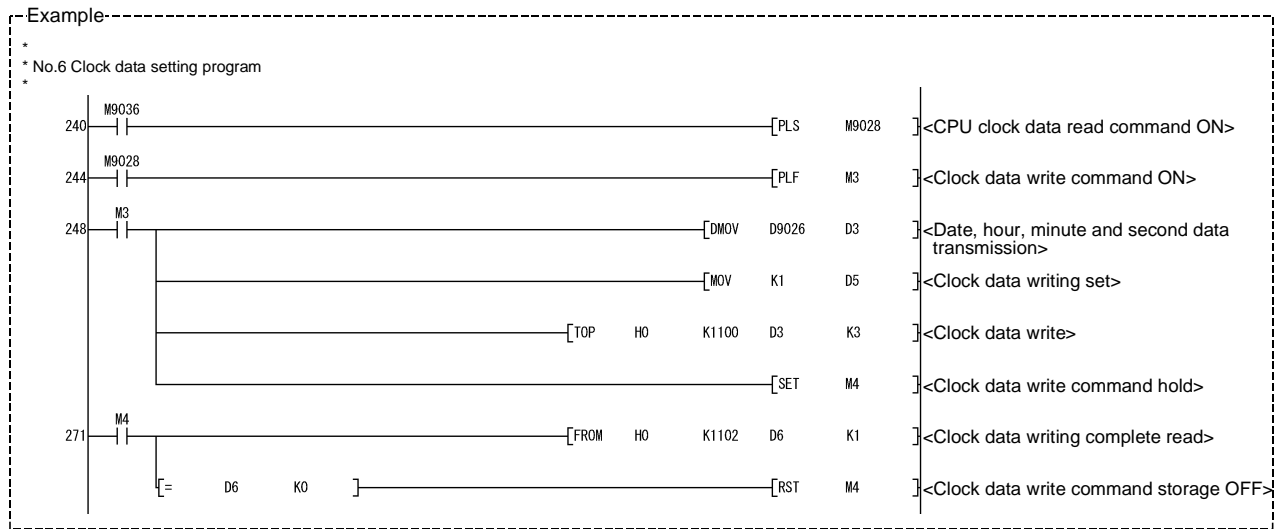

Chapter 14

TROUBLESHOOTING

The "errors" and "warnings" detected by the AD75 are explained in this chapter.

Errors and warnings can be confirmed with the AD75 LED display and peripheral devices. When an error or warning is detected, confirm the detection details and carry out the required measures.

14.1	Error and warning details.....	14- 2
14.2	List of errors	14- 6
14.3	List of warnings	14- 30
14.4	Start during error history.....	14- 36

14.1 Error and warning details

(1) Errors

■ Types of errors

Errors detected by the AD75 include parameter setting range errors and errors at the operation start or during operation.

(1) Parameter setting range errors

The parameters are checked when and at the rising edge (OFF → ON) of the PLC READY signal [Y1D]. An error will occur if there is a mistake in the parameter setting details at that time.

When this kind of error occurs, the AD75 READY signal does not turn OFF. To cancel this kind of error, set the correct value in the parameter for which the error occurred, and then turn ON the PLC READY signal [Y1D].

(2) Errors at the operation start or during operation

These are errors that occur at the operation start or during operation when using positioning control, JOG operation, manual pulse generator operation, etc. If an axis error occurs during interpolation operation, the error No. will be stored in both the reference axis and the interpolation axis.

Note that in the following cases (a) and (b), the axis error No. will only be stored in the reference axis during analysis of the positioning data set in each point of the positioning start data table.

(a) When the interpolation axis is BUSY

(b) When the error occurred in positioning data or parameters unrelated to interpolation control.

If the error occurred at the simultaneous start of a positioning operation, the axis error storage details will differ depending on whether the error occurred before or after the simultaneous start.

- If the error occurred before the simultaneous start (illegal axis No., other axis BUSY, etc.), an "error before simultaneous start" will occur.
- If the error occurred after the simultaneous start (positioning data error, software stroke limit error, etc.), an error code corresponding to the axis in which the error occurred will be stored. Because a simultaneous start cannot be carried out due to this, a "simultaneous start not possible error" error code will be stored in all axes in which an error has not occurred.

The axis operation status will be displayed as "error occurring" for axes in which an error occurred.

If an error occurs during operation, any moving axes will deceleration stop, and their operation status will be displayed as "error occurring".

Both axes will decelerate to a stop during interpolation operations, even if the error occurs in only one axis.

(3) Types of error codes

Error code	Error type
001 to 009	Fatal error
010 to 099	Error at selection of stepping motor mode
100 to 199	Common error
200 to 299	Error at zero point return
300 to 399	Error during JOG operation
500 to 599	Error during positioning operation
900 to 999	Error during parameter setting range check

■ Error storage

When an error occurs, the error detection signal turns ON, and the error code corresponding to the error details is stored in the following buffer memory address (Md.33 Axis error No.) for axis error No. storage. Note that there is a delay of up to 56.8ms after the error detection signal turns ON until the error code is stored.

Axis No.	Error detection signal	Buffer memory address
1	XA	807
2	XB	907
3	XC	1007

A new error code is stored in the buffer memory (Md.33 Axis error No.) for axis error storage every time an error occurs.

(2) Warnings

■ Types of warnings

- (1) Warning detection includes system warnings and axis warnings.

The types of system warnings are shown below.

- System control data setting errors
An axis warning for axis 1 will occur.
- Positioning data setting errors
An axis warning for each axis will occur.
Note that a warning will occur for the following axes when an interpolation designation or axis setting error occurs.
 - During axis 1 and axis 2 interpolation control: Axis 1
 - During axis 2 and axis 3 interpolation control: Axis 2
 - During axis 3 and axis 1 interpolation control: Axis 3

- (2) Axis warnings occur due to setting warnings from operations such as positioning operations, JOG operations, manual pulse generator operations, or system errors. They can be canceled by turning ON the "Cd.12 Axis error reset".

Note that some warnings cannot be canceled unless the cause of the warning is eliminated.

The axis operation status does not change even if an axis warning occurs.

- (3) Types of warning codes

Warning code	Error type
100 to 199	Common warning
300 to 399	Warning during JOG operation
400 to 499	Warning during manual pulse generator operation
500 to 599	Warning during positioning operation
900 to 999	Warning during system control data range check

■ Warning storage

- (1) When an axis warning occurs, the warning code corresponding to the warning details is stored in the following buffer memory (Md.34 Axis warning No.) for axis warning No. storage.

Axis No.	Buffer memory address
1	808
2	908
3	1008

- (2) When an axis warning occurs in a positioning operation, etc., "1" is set in bit 9 (b9) of the following buffer memory (Md.40 Status) for axis status storage.

Axis No.	Buffer memory address
1	817
2	917
3	1017

(3) Resetting errors and warnings

An error state is canceled after the following processing has been carried out by setting a "1" in the buffer memory for axis error resetting (Cd.12 Axis error reset) [1151 (for axis 1)], [1201 (for axis 2)], and [1251 (for axis 3)].

- Axis error detection signal turned OFF
- "Md.33 Axis error No." cleared
- "Md.40 Axis warning detection (b9)" turned OFF
- "Md.34 Axis warning No." cleared
- Changing of the operation status from "error occurring" to "standing by".
- Changing of the operation status from "step error occurring" to "standing by".

(4) Invalid operations

For the following operations, the setting details will be invalidated, and an error or warning will not occur.

- Speed change during machine zero point return
- Speed change before operation (Speed override change, skip command, continuous operation interruption request)
- Axis stop during axis stop
- Axis sudden stop during axis stop
- Axis stop before axis operation
- Axis sudden stop before axis operation

(5) Checking the Error or Warning Number

Use the following methods to check the error or warning number.

- (1) "17-segment LED display function" on the front panel of main body of AD75 (Refer to section 13.4.)
- (2) "Buffer memory batch monitor function" of GPP function software package
- (3) "Monitor function" of software package for AD75

For details of (2) and (3), refer to the GPP Function Software Package Operating Manual or AD75 Software Package Operating Manual.

14.2 List of errors

Description of the errors and remedies are shown below.

Division of error	Error code	Error name	Description	Action at occurrence of error
—	000	(Normal)	—	—
Fatal error	001	Fault	Hardware error	The system is stopped.
	003	Division by zero		
	004	Overflow		
	005	Underflow		
Error at selection of stepping motor mode	051	Outside position command range	<ul style="list-style-type: none"> The position data in the parameter is out of the setting range for the stepping motor mode. The positioning address or movement amount setting in the positioning data is out of the setting range for the stepping motor mode. 	<ul style="list-style-type: none"> The AD75 READY signal (X0) does not turn OFF. Failure to start.
	052	Outside speed command range	<ul style="list-style-type: none"> The speed data in the parameter is out of the setting range for the stepping motor mode. The command speed setting in the positioning data is out of the setting range for the stepping motor mode. 	<ul style="list-style-type: none"> The AD75 READY signal (X0) does not turn OFF. Failure to start.
Common	100	Peripheral device stop during operation	A stop command is supplied during operation from a peripheral device.	Stopping according to the sudden stop (stopping group 2) setting (deceleration and stop/sudden stop) selected in detail parameter 2 (However, deceleration and stop only during manual pulse generator operation)
	101	PLC READY OFF during operation	The "PLC READY" signal (Y1D) is turned OFF during operation.	Stopping according to sudden stop (stopping group 2) setting (deceleration and stop/sudden stop) selected in detail parameter 2 (However, deceleration and stop only during manual pulse generator operation)
	102	Drive unit READY OFF	The "Drive unit READY" signal is turned OFF during operation.	Immediate stop.

	Relevant buffer memory address			Setting range (Setting given in sequence program)	Remedy
	Axis 1	Axis 2	Axis 3		
	—	—	—	—	—
	—	—	—	—	<ul style="list-style-type: none"> • Check if there are effects of noise or the like. • Check for hardware errors.
	Refer to sections 5.2.1 to 5.2.6 and 5.3.			<p><Position data, positioning address/movement amount in parameter> (In stepping motor mode)</p> <ul style="list-style-type: none"> • [mm] [inch] [pulse] -134217728 to 134217727 • [degree] INC: -134217728 to 134217727 ABC: 0 to 35999999 • Speed/position changeover 0 to 134217727 	<ul style="list-style-type: none"> • Correct the position data in the parameter to within the setting range of the stepping motor mode specified in sections 5.2.1 to 5.2.6. • Change the positioning address/movement amount to within the setting range for the stepping motor specified in section 5.3.
	Refer to sections 5.2.1 to 5.2.6 and 5.3.			<p><Speed data of parameter and command speed of positioning data> 1 to 62500 [pulse/s] 1 to 37500000 [mm/min, etc.]</p>	<ul style="list-style-type: none"> • Correct the speed data of the parameter to within the setting range for the stepping motor mode specified in sections 5.2.1 to 5.2.6. • Correct the command speed of the positioning data to within the setting range for the stepping motor mode specified in section 5.3.
	—	—	—	—	Remove the cause of stopping and perform axis error resetting (refer to [3] in section 14.1) to remove the error.
	—	—	—	—	<ul style="list-style-type: none"> • Examine the sequence program in which the "PLC READY" signal (Y1D) is turned ON or OFF. • Perform axis error resetting (refer to [3] in section 14.1) to remove the error.
	—	—	—	—	Check the state of the power supply of the drive unit and the wiring to the drive unit and the connection state of the connectors, and perform axis error resetting (refer to [3] in section 14.1) to remove the error.

Division of error	Error code	Error name	Description	Action at occurrence of error
Common	103	Test mode fault during operation	Communication between the personal computer and AD75 is interrupted in test mode.	Stopping according to sudden stop (stopping group 3) setting (deceleration and stop/sudden stop) selected in detail parameter 2 (However, deceleration and stop only during manual pulse generator operation)
	104	Hardware stroke limit (+)	An upper hardware stroke limit signal (FLS) is turned OFF.	Stopping according to sudden stop (stopping group 1) setting (deceleration and stop/sudden stop) selected in detail parameter 2 (However, deceleration and stop only during manual pulse generator operation)
	105	Hardware stroke limit (-)	A lower hardware stroke limit signal (RLS) is turned OFF.	
	106	Stop signal ON at start	A start request is issued while the stop signal is turned ON.	Positioning start is not carried out.
107	PLC READY OFF --> ON in busy	The "PLC READY" signal is turned OFF while the busy signal is turned ON.	The AD75 READY signal (X0) is not turned OFF.	
Zero point return	201	Start at zero point	Near-point dog method machine zero point return is started with an invalidated zero point return retry setting when the zero point return completion flag is ON.	Machine zero point return start is not carried out.

Relevant buffer memory address			Setting range (Setting given in sequence program)	Remedy
Axis 1	Axis 2	Axis 3		
—	—	—	—	Check the I/F on the PC side of cable connection for errors.
—	—	—	—	After making an axis error reset (refer to [3] in Section 14.1), perform manual control operation (refer to Chapter 11) to move the axis to the position where the upper limit signal (FLS) will not be turned OFF.
—	—	—	—	After making an axis error reset (refer to [3] in Section 14.1), perform manual control operation (refer to Chapter 11) to move the axis to the position where the lower limit signal (RLS) will not be turned OFF.
—	—	—	—	<p>Check the ON/OFF statuses of the stop command (output signal/external input issued to AD75) and turn OFF the active stop commands.</p> <ul style="list-style-type: none"> • Output signals issued to AD75 ... Axis 1: Y13, Axis 2: Y14, Axis 3: Y1C • External inputs ... External device connection connector: Stop signal (STOP) <p>After checking the status of the stop command, perform axis error resetting (refer to [3] in section 14.1) to remove the error, then turn ON the start signal.</p>
—	—	—	—	Turn ON the PLC READY signal (Y1D) with the BUSY signals of all axes OFF.
78	228	378	<Zero point return retry> 0, 1	<ul style="list-style-type: none"> • The zero point return retry function (refer to section 12.2.1) is validated (setting: 1). • Using manual control operation (refer to Chapter 11) to move from the current position (zero point) and perform machine zero point return.

Division of error	Error code	Error name	Description	Action at occurrence of error
Zero point return	206	Count method movement amount fault	The "setting for the movement amount after near-point dog ON" zero point return detail parameter is smaller than the distance necessary for deceleration and stop from the zero point return speed in count method 1), 2) machine zero point return.	Machine zero point return start is not carried out. High-speed zero point return start is not carried out.
	207	Zero point return request ON	The zero point return request flag is set at the start of high-speed zero point return (positioning start No. 9002).	
	208	Outside creep speed range	The value specified as a creep speed exceeds the value specified as a zero point return speed.	Machine zero point return start is not carried out.
	209	Zero point return restart not possible	The restart command is turned ON after the machine zero point return is stopped using a stop signal.	The restart is not carried out.
JOG	300	Outside JOG speed range	The JOG speed is out of the setting range at the start of JOG operation.	If the setting is out of the range at the start of JOG operation, JOG operation is not carried out.

Relevant buffer memory address			Setting range (Setting given in sequence program)	Remedy
Axis 1	Axis 2	Axis 3		
80 81	230 231	380 381	<Setting for the movement amount after near-point dog ON> (In standard mode) 0 to 2147483647 (In stepping motor mode) 0 to 134217727	<ul style="list-style-type: none"> • Calculate the distance of travel according to the speed limit, zero point return speed and deceleration speed, and determine the movement amount after activation at the near-point dog so that the distance of travel is larger than the deceleration distance. • Set a smaller zero point return speed. • Adjust the near-point dog position so that the movement amount after activation at the near-point dog becomes longer. (Refer to sections 8.2.7 and 8.2.8)
74 75	224 225	374 375	<Zero point return speed> (In standard mode) 1 to 1000000 [pulse/s] 1 to 600000000 [mm/min, etc.] (In stepping motor mode) 1 to 62500 [pulse/s] 1 to 375000000 [mm/min, etc.]	
1150	1200	1250	<Positioning start No.> 1 to 600, 7000 to 7010 8001 to 8050, 9001 to 9003	Execute mechanical zero point return (positioning start No. 9001). (Refer to section 8.2)
76 77	226 227	376 377	<Creep speed> (In standard mode) 1 to 1000000 [pulse/s] 1 to 600000000 [mm/min, etc.] (In stepping motor mode) 1 to 62500 [pulse/s] 1 to 375000000 [mm/min, etc.]	Correct the creep speed to within the zero point return speed. (Refer to section 5.2.5)
1150	1200	1250	<Positioning start No.> 1 to 600, 7000 to 7010 8001 to 8050, 9001 to 9003	Execute mechanical zero point return (positioning start No. 9001). (Refer to section 8.2)
1160 1161	1210 1211	1260 1261	<JOG speed> (In standard mode) 1 to 1000000 [pulse/s] 1 to 600000000 [mm/min, etc.] (In stepping motor mode) 1 to 62500 [pulse/s] 1 to 375000000 [mm/min, etc.]	Correct the JOG speed to within the setting range. (Refer to section 11.2)

Division of error	Error code	Error name	Description	Action at occurrence of error
Positioning operation	500	Illegal condition data No.	The condition data number specified in the parameter of special positioning start data is out of the setting range at the block start in the special starting method when the conditional start, wait start, simultaneous start or FOR (condition) requiring condition data is commanded. ($1 \leq \text{Condition data No.} \leq 10$)	Operation is terminated.
	501	Simultaneous start fault	<ul style="list-style-type: none"> The target axis of simultaneous start is busy. No axis designation is given in condition data. The axis designated in condition data is the own axis. 	At start: Operation does not start. During operation: Operation is terminated.
	502	Illegal start data No.	<ul style="list-style-type: none"> The positioning data number to be executed is other than 1 to 600, 7000 to 7010, or 9001 to 9003. 	Positioning data is not executed.
	503	No command speed	The current speed ("-1") is specified as a command speed of the positioning data to be executed first in positioning start.	Operation at the start is not carried out.
	504	Outside linear movement amount range	<ul style="list-style-type: none"> The movement amount in each axis for each piece of data exceeds $1073741824 (2^{30})$ during linear interpolation with "synthetic speed" specified as an "interpolation speed designation method" parameter. The positioning address of the INC command is equal to or smaller than -360.00000 or equal to or larger than 360.00000 with the "degree" unit setting and inequality between the upper and the lower software stroke limits. 	At start: Operation does not start. During operation: Immediate stop
	506	Large arc error deviation	The difference between the radius from the start point to the center point and the radius from the end point to the center point exceeds the "allowable range of arc interpolation error" during arc interpolation with center point designation.	At start: The arc interpolation control with center point designation is not executed. During operation: Immediate stop

Relevant buffer memory address			Setting range (Setting given in sequence program)	Remedy
Axis 1	Axis 2	Axis 3		
Refer to section "5.4 List of start block data."			<Condition data No.> 1 to 10	Examine the condition data number. (Refer to Da. 13 in section 5.4)
Refer to section "5.5 List of condition data."			<Condition operator> Axis designation: 09 _H , 0A _H , 0B _H , 0C _H , 0D _H , 0E _H	Correct the condition operator. (Refer to section 5.5 Da. 15)
1150	1200	1250	<Positioning start No.> 1 to 600, 7000 to 7010, 9001 to 9003	Correct the positioning start number.
Refer to section "5.3 List of positioning data."			<Command speed> (In standard mode) 1 to 1000000 [pulse/s] 1 to 600000000 [mm/min, etc.] (In stepping motor mode) 1 to 62500 [pulse/s] 1 to 37500000 [mm/min, etc.]	Correct the positioning data.
			<Positioning address/movement amount> (In standard mode) • [mm] [inch] [pulse] [degree (INC)] -2147483648 to 2147483647 • [degree (ABS)] 0 to 35999999 • Speed/position changeover 0 to 2147483647 (In stepping motor mode) • [mm] [inch] [pulse] [degree (INC)] -134217728 to 134217727 • [degree (ABS)] 0 to 35999999 • Speed/position changeover 0 to 134217727 <Arc address> (In standard mode) -2147483648 to 2147483647 (In stepping motor mode) —	Examine the positioning address. • Correct the center point address (positioning address). • Correct the end point address (arc address).
			<Allowable circular interpolation error width> (In standard mode) 0 to 1000000 (In stepping motor mode) —	Correct the allowable range value of the arc interpolation error.
60 61	210 211	360 361		

Division of error	Error code	Error name	Description	Action at occurrence of error
Positioning operation	507	Start outside stroke limit (+)	Positioning is started at a position outside the upper software stroke limit.	Operation at the start is not carried out.
	508	Start outside stroke limit (-)	Positioning is started at a position outside the lower software stroke limit.	
	509	Movement outside stroke limit (+)	Positioning start is made to a position beyond the upper software stroke limit.	
	510	Movement outside stroke limit (-)	Positioning start is made to a position beyond the lower software stroke limit.	
	511	Movement outside stroke limit (+)	The address of the positioning data to be executed next exceeds the upper software stroke limit.	Immediate stop after completion of preceding positioning data during continuous path control
	512	Movement outside stroke limit (-)	The address of the positioning data to be executed next exceeds the lower software stroke limit.	
	514	Outside current value change range	The address of current value change is outside the range between 0 and 359.99999 in the degree unit.	The current value is not changed.
	515	Current value change not possible	<ul style="list-style-type: none"> • The "continuous path control" operation pattern is specified in the positioning data of the current value change control method. • The "current value change" control method is specified in the data following the positioning data of the "continuous path control" operation pattern. 	
	516	Continuous path control not possible	<ul style="list-style-type: none"> • Continuous path control is designated with the speed control, speed/position changeover, sizing feed or other control method where continuous path control is impossible. • The data preceding speed control, speed/position changeover or sizing feed is continuous path control. • The continuous positioning control is designated for speed control. 	

Relevant buffer memory address			Setting range (Setting given in sequence program)	Remedy	
Axis 1	Axis 2	Axis 3			
Software stroke limit upper limit value			<Software stroke limit upper/lower limit value> (In standard mode) • [mm] [inch] [pulse] -2147483648 to 2147483647	Change the current feed to within the range of the software stroke limit, using manual control operation (refer to Chapter 11).	
16	166	316			
17	167	317			
Software stroke limit lower limit value			• [degree] 0 to 35999999 (In stepping motor mode)		
18	168	318	• [mm] [inch] [pulse] -134217728 to 134217727	• Correct the positioning address to within the range of the software stroke limit. • Change the current feed to within the range of the software stroke limit, using manual control operation (refer to Chapter 11).	
19	169	319			• [degree] 0 to 35999999
Refer to section "5.3 List of positioning data."			<Positioning address/movement amount> (In standard mode) • [mm] [inch] [pulse] -2147483648 to 2147483647 • [degree] 0 to 35999999 (In stepping motor mode) • [mm] [inch] [pulse] -134217728 to 134217727 • [degree] 0 to 35999999		Correct the positioning address/movement amount of the positioning data to within the range of the software stroke limit. (Refer to section 5.3 Da. 5)
1154	1204	1254	<New current value> [degree] 0 to 35999999		Change the new current value to within the setting range. (Refer to section 9.2.10)
1155	1205	1255			
Refer to section "5.3 List of positioning data."			<Control method> 01 _H to 11 _H , 20 _H • 03 _H , 06 _H : 1 to 2 axis fixed-dimension control • 0D _H , 0E _H : Speed control • 11 _H : Current value change • Speed/position changeover control: 0F _H , 10 _H <Operation pattern> 00, 01, 11 • 01: Continuous positioning control • 11: Continuous path control	Do not designate the current value change in the positioning data following continuous path control. (Refer to section 9.2.10)	
				• Do not designate speed control, sizing feed, or speed/position changeover control in the positioning data following continuous path control. • Do not perform sizing feed, speed control, or speed/position changeover control in the operation pattern of continuous path control. • Do not perform speed control in the operation pattern of continuous positioning control. (Refer to Chapter 9)	

Division of error	Error code	Error name	Description	Action at occurrence of error
Positioning operation	518	Outside operation pattern range	The operation pattern setting is "2."	At start: Operation does not start. During operation: Stopping according to sudden stop (stopping group 3) setting (deceleration and stop/sudden stop) selected in detail parameter 2 (However, deceleration and stop only during manual pulse generator operation)
	519	Interpolation while target axis is BUSY	Interpolation is started during operation in the target axis.	
	520	Unit group disagreement	The unit group of the target axis of interpolation is different.	
	521	Illegal interpolation description command	<ul style="list-style-type: none"> Interpolation data is specified with 1-axis module. Interpolation data is specified for axis 2 with 2-axis module. 	
	522	Command speed setting error	The command speed is set at "0."	
	524	Control method setting error	The control method setting is out of the range.	
	525	Auxiliary point setting error	<p>One of the following cases is applicable with auxiliary point-designated arc interpolation.</p> <ul style="list-style-type: none"> Start point = Auxiliary point End point = Auxiliary point The start point, end point and auxiliary point are in a line. The auxiliary point address or center point address is out of the range between -2147483648 and 2147483647. 	At start: Operation does not start. During operation: Immediate stop
	526	End point setting error	<ul style="list-style-type: none"> The start point is the end point with the auxiliary point-designated arc interpolation. The end point address is outside the scope of -2147483648 to 2147483647 in the circular interpolation with auxiliary point designation and center point designation. 	

Relevant buffer memory address			Setting range (Setting given in sequence program)	Remedy
Axis 1	Axis 2	Axis 3		
			<Operation pattern>00, 01, 11 • 00: Positioning complete • 01: Continuous positioning control • 11: Continuous path control	Correct the operation pattern. (Refer to section 5.3 Da. 1)
				Correct the control method. (Refer to section 5.3 Da. 2)
0	150	300	<Unit setting> 0, 1, 2, 3	Correct the positioning data or the "unit setting" parameter. (Refer to section 9.1.6)
			<Control method> 01 _H to 11 _H , 20 _H • 03 _H , 06 _H : 1 to 2 axis fixed-dimension control • 0D _H , 0E _H : Speed control • 11 _H : Current value change • Speed/position changeover control: 0F _H , 10 _H	Correct the control method. (Refer to section 5.3 Da. 2)
Address storing the command speed of each of positioning data No. 1 to 600			<Command speed> (In standard mode) 1 to 1000000 [pulse/s] 1 to 600000000 [mm/min, etc.] (In stepping motor mode) 1 to 62500 [pulse/s] 1 to 37500000 [mm/min, etc.]	Correct the command speed. (Refer to section 5.3 Da. 7)
			<Control method> 01 _H to 11 _H , 20 _H • 03 _H , 06 _H : 1 to 2 axis fixed-dimension control • 0D _H , 0E _H : Speed control • 11 _H : Current value change • Speed/position changeover control: 0F _H , 10 _H	Correct the control method or parameter. (Refer to section 9.1.6)
Refer to section "5.3 List of positioning data."			<Positioning address/movement amount> (In standard mode) • [mm] [inch] [pulse] -2147483648 to 2147483647 (Unit [degree] cannot be set.)	Correct the address of the auxiliary point (arc address). (Refer to section 9.2.6)
			<Arc address> -2147483648 to 2147483647 (In stepping motor mode) —	Correct the end point address (positioning address). (Refer to section 9.2.6)

Division of error	Error code	Error name	Description	Action at occurrence of error
Positioning operation	527	Center point setting error	Circular interpolation with center point designation applicable to one of the following <ul style="list-style-type: none"> • Start point = Center point • End point = Center point • The center point address is out of the range between -2147483648 and 2147483647 	At start: Operation does not start. During operation: Immediate stop
	530	Outside address range	<ul style="list-style-type: none"> • The positioning address setting is a negative value in the speed/position changeover control mode. • The positioning address setting of ABS1 or ABS2 is out of the range between 0 and 359.99999 [degrees]. 	At start: Operation does not start. During operation: Stopping according to sudden stop (stopping group 3) setting (deceleration and stop/sudden stop) selected in detail parameter 2 (However, deceleration and stop only during manual pulse generator operation)
	532	Simultaneous start not possible	An error other than this one is developed to a target axis of simultaneous start.	
	533	Condition data error	One of the following is applicable when condition data is referred to for a conditional start, wait start or JUMP command. <ul style="list-style-type: none"> • The target condition setting is out of the setting range. • The condition operator setting is out of the setting range. • The condition operator is range designation "1" and parameter 1 is bigger than parameter 2. 	Operation is terminated.
	534	Special start command error	The command code of the special start command is out of the setting range.	
	536	M code ON signal ON start	Positioning start is performed when the "M code ON" signal (XD, XE, XF) is turned ON.	
	537	PLC READY OFF start	Positioning start is performed when "PLC READY" (Y1D) is turned OFF.	
	538	READY ON start	Positioning start is performed when AD75 READY (X0) is turned ON.	Operation does not start at the start.
543	Outside start number range	The "positioning start number" setting is other than 1 to 600, 7000 to 7010, 8001 to 8050, or 9000 to 9003 at positioning start.		
544	Outside radius range	<ul style="list-style-type: none"> • The arc radius exceeds 536870912. • The address of auxiliary point, center point and end point are outside the scope of -2147483648 to 2147483647 with circular interpolation. 	At start: Operation does not start. During operation: Immediate stop	

Relevant buffer memory address			Setting range (Setting given in sequence program)	Remedy
Axis 1	Axis 2	Axis 3		
Refer to section "5.3 List of positioning data."			<Positioning address/movement amount> (In standard mode) • [mm] [inch] [pulse] [degree (INC)] -2147483648 to 2147483647 • [degree (ABS)] 0 to 35999999 <Arc address> -2147483648 to 2147483647 (In stepping motor mode) —	Correct the center point address (arc address). (Refer to section 9.2.7)
			—	Correct the positioning address. (Refer to section 9.2.9)
			—	Refer to the error history to search for axes developing errors other than this one and remove the causes of the errors. Correct the start block data and positioning data.
Refer to section "5.4 Start block data."			—	Correct the start block data.
			<Special command> 00 _H to 07 _H	Correct the special start data. (Refer to section 5.4 Da. 12)
1153	1203	1253	<M code OFF request> 1: The M code ON signal is turned OFF.	Turn the "M code ON" signal OFF then start. (Refer to section 12.6.3)
—	—	—	—	Check the sequence program in which the PLC READY signal (Y1D) is turned ON or OFF. Turn PLC READY ON then start.
—	—	—	—	Check AD75 READY OFF then start. (Refer to section 3.4.2)
1150	1200	1250	<Positioning start No.> 1 to 600, 7000 to 7010, 8001 to 8050, 9001 to 9003	Correct the positioning start No.
Refer to section "5.3 List of positioning data."			<Max. radius> 536870912	Correct the positioning data. (Refer to sections 9.2.6 and 9.2.7)

Division of error	Error code	Error name	Description	Action at occurrence of error
Parameter	900	Outside unit setting range	The setting range of "unit setting" in basic parameter 1 is out of the setting range.	At start: Operation does not start. During operation: Immediate stop
	901	No. of pulses per rotation setting error	The setting range of "No. of pulses per rotation" in basic parameter 1 is out of the setting range.	
	902	Movement amount per rotation setting error	The setting range of "movement amount per rotation" in basic parameter 1 is out of the setting range.	
	903	Unit magnification setting error	The setting range of "unit magnification" in basic parameter 1 is out of the setting range.	
	904	Pulse output mode error	The setting range of "pulse output mode" in basic parameter 1 is out of the setting range.	
	905	Rotation direction setting error	The setting range of "rotation direction setting" in basic parameter 1 is out of the setting range.	
	910	Outside speed limit value range	The setting range of "speed limit value" in basic parameter 2 is out of the setting range.	At power-on or when the PLC READY signal (Y1D) is turned ON: The AD75 READY signal (X0) is not turned ON. At start: Operation does not start.
	911	Outside acceleration time range	The setting range of "acceleration time 0" in basic parameter 2 is out of the setting range.	
	912	Outside deceleration time range	The setting range of "deceleration time 0" in basic parameter 2 is out of the setting range.	
	913	Outside bias speed range	The setting range of "bias speed at start" in basic parameter 2 is out of the setting range.	
	921	Software stroke limit upper limit	<ul style="list-style-type: none"> The "software stroke limit upper limit value" setting in detail parameter 1 is out of the setting range with "degree" unit. The software stroke limit upper limit value is smaller than the software stroke limit lower limit value with a unit other than "degree". 	The AD75 READY signal (X0) is not turned OFF.

Relevant buffer memory address			Setting range (Setting given in sequence program)	Remedy
Axis 1	Axis 2	Axis 3		
0	150	300	0, 1, 2, 3	
1	151	301	1 to 65535	
2	152	302	1 to 65535	
3	153	303	1, 10, 100, 1000	
4	154	304	0, 1, 2, 3	
5	155	305	0, 1	
6 7	156 157	306 307	(In standard mode) 1 to 1000000 [pulse/s] 1 to 600000000 [mm/min, etc.] (In stepping motor mode) 1 to 62500 [pulse/s] 1 to 37500000 [mm/min, etc.]	Change the setting to within the setting range and turn OFF then ON the PLC READY signal (Y1D).
8 9	158 159	308 309	(One-word type) 1 to 65535 (Two-word type) 1 to 8388608	
10 11	160 161	310 311	(One-word type) 1 to 65535 (Two-word type) 1 to 8388608	
12 13	162 163	312 313	(In standard mode) 1 to 1000000 [pulse/s] 1 to 600000000 [mm/min, etc.] (In stepping motor mode) 1 to 62500 [pulse/s] 1 to 37500000 [mm/min, etc.]	
16 17	166 167	316 317	(In standard mode) • [mm] [inch] [pulse] -2147483648 to 2147483647 • [degree] 0 to 35999999 (In stepping motor mode) • [mm] [inch] [pulse] -134217728 to 134217727 • [degree] 0 to 35	<ul style="list-style-type: none"> • Change the setting to within the setting range. • In case of a unit other than "degree," change the settings so that the lower limit value is smaller than the upper limit value.

Division of error	Error code	Error name	Description	Action at occurrence of error
Parameter	922	Software stroke limit lower limit	<ul style="list-style-type: none"> The "software stroke limit lower limit value" setting in detail parameter 1 is out of the setting range with "degree" unit. The software stroke limit upper limit value is smaller than the software stroke limit lower limit value with a unit other than "degree." 	The AD75 READY signal (X0) is not turned OFF.
	923	Software stroke limit selection	The setting range of "software stroke limit selection" in detail parameter 1 is out of the setting range.	
	924	Software stroke limit valid/invalid setting	The setting range of the "software stroke limit valid/invalid setting" in detail parameter 1 is out of the setting range.	
	925	Illegal torque limit setting value	The setting range of the "torque limit setting value" in detail parameter 1 is out of the setting range.	
	926	Command in-position range	The setting range of the "command in-position range" in detail parameter 1 is out of the setting range.	
	927	M code ON timing error	The setting range of the "M code ON signal output timing" in detail parameter 1 is out of the setting range.	
	928	Speed changeover mode error	The setting range of the "speed changeover mode" in detail parameter 1 is out of the setting range.	
	929	Interpolation speed designation method	The setting range of the "interpolation speed designation method" in detail parameter 1 is out of the setting range.	
	930	Current value update request error	The setting range of the "current feed value during speed control" in detail parameter 1 is out of the setting range.	
	931	Manual pulse generator selection error	The "manual pulse generator selection" setting in detail parameter 1 is out of the setting range.	

	Relevant buffer memory address			Setting range (Setting given in sequence program)	Remedy
	Axis 1	Axis 2	Axis 3		
18 19	168 169	318 319	(In standard mode) • [mm] [inch] [pulse] -2147483648 to 2147483647 • [degree] 0 to 35999999 (In stepping motor mode) • [mm] [inch] [pulse] -134217728 to 134217727 • [degree] 0 to 35999999	<ul style="list-style-type: none"> • Change the setting to within the setting range. • Change the settings so that the lower limit value is smaller than the upper limit value with a unit other than "degree." 	
20	170	320	0, 1	Change the setting to within the setting range and turn OFF then ON the PLC READY signal (Y1D).	
21	171	321	0, 1		
22 23	172 173	322 323	(In standard mode) • [mm] [inch] [pulse] 1 to 32767000 • [degree] 1 to 32767 (In stepping motor mode) • [mm] [inch] [pulse] 1 to 2047937 • [degree] 1 to 2047		
24	174	324	1 to 500		
25	175	325	0, 1		
26	176	326	0, 1		
27	177	327	0, 1		
28	178	328	0, 1, 2		
29	179	329	0: Manual pulse generator operation ignored 1: Manual pulse generator connected to axis 1 is used. 2: Manual pulse generator connected to axis 2 is used. 3: Manual pulse generator connected to axis 3 is used.		

Division of error	Error code	Error name	Description	Action at occurrence of error
Parameter	932	Pulse logic selection error	The "logic selection for pulse output to the drive unit" setting in detail parameter 1 is out of the setting range.	The AD75 READY signal (X0) is not turned OFF.
	933	Acceleration/deceleration time size error	The "size selection for acceleration/deceleration time" setting in detail parameter 1 is out of the setting range.	
	938	Backlash compensation amount error 2	The movement amount per pulse converted to the pulse count exceeds 256 pulses.	
	950	Acceleration time 1 setting error	The setting range of "acceleration time 1" in detail parameter 2 is out of the setting range.	At start: Failure to start During operation: Stopping according to sudden stop (stopping group 3) setting (deceleration and stop/sudden stop) selected in detail parameter 2 (However, deceleration and stop only during manual pulse generator operation)
	951	Acceleration time 2 setting error	The setting range of "acceleration time 2" in detail parameter 2 is out of the setting range.	
	952	Acceleration time 3 setting error	The setting range of "acceleration time 3" in detail parameter 2 is out of the setting range.	
	953	Deceleration time 1 setting error	The setting range of "deceleration time 1" in detail parameter 2 is out of the setting range.	
	954	Deceleration time 2 setting error	The setting range of "deceleration time 2" in detail parameter 2 is out of the setting range.	
	955	Deceleration time 3 setting error	The setting range of "deceleration time 3" in detail parameter 2 is out of the setting range.	
	956	JOG speed limit value error	<ul style="list-style-type: none"> The setting range of the "JOG speed limit value" in detail parameter 2 is out of the setting range. The "JOG speed limit value" setting in detail parameter 2 exceeds the speed limit value. 	
	957	JOG acceleration selection setting error	The setting range of "JOG acceleration time selection" in detail parameter 2 is out of the setting range.	

	Relevant buffer memory address			Setting range (Setting given in sequence program)	Remedy	
	Axis 1	Axis 2	Axis 3			
	30	180	330	0: Positive logic 1: Negative logic	Change the setting to within the setting range and turn OFF then ON the PLC READY signal (Y1D).	
	31	181	331	0: One-word type 1: Two-word type		
	15	165	315	0 to 255	Change the setting so that the movement per pulse converted to the pulse count becomes fewer than 256 pulses. (Refer to section 12.3.1)	
	36 37	186 187	336 337	(One-word type) 1 to 65535 (Two-word type) 1 to 8388608	Change the setting to within the setting range and turn OFF then ON the PLC READY signal (Y1D).	
	38 39	188 189	338 339	(One-word type) 1 to 65535 (Two-word type) 1 to 8388608		
	40 41	190 191	340 341	(One-word type) 1 to 65535 (Two-word type) 1 to 8388608		
	42 43	192 193	342 343	(One-word type) 1 to 65535 (Two-word type) 1 to 8388608		
	44 45	194 195	344 345	(One-word type) 1 to 65535 (Two-word type) 1 to 8388608		
	46 47	196 197	346 347	(One-word type) 1 to 65535 (Two-word type) 1 to 8388608		
	48 49	198 199	348 349	(In standard mode) 1 to 1000000 [pulse/s] 1 to 600000000 [mm/min, etc.] (In stepping motor mode) 1 to 62500 [pulse/s] 1 to 37500000 [mm/min, etc.]		<ul style="list-style-type: none"> • Change the setting to within the setting range and turn OFF then ON the PLC READY signal (Y1D). • Change the setting to within the speed limit value.
	50	200	350	0, 1, 2, 3		Change the setting to within the setting range and turn OFF then ON the PLC READY signal (Y1D).

Division of error	Error code	Error name	Description	Action at occurrence of error
Parameter	958	JOG deceleration selection setting error	The setting range of "JOG deceleration time selection" in detail parameter 2 is out of the setting range.	At start: Failure to start During operation: Stopping according to sudden stop (stopping group 3) setting (deceleration and stop/sudden stop) selected in detail parameter 2 (However, deceleration and stop only during manual pulse generator operation)
	959	Acceleration/deceleration selection setting error	The setting range of "acceleration/deceleration process selection" in detail parameter 2 is out of the setting range.	
	960	S-curve ratio setting error	The setting range of the "S-curve ratio" in detail parameter 2 is out of the setting range.	
	962	Illegal sudden stop deceleration time	The setting range of the "sudden stop deceleration time" in detail parameter 2 is out of the setting range.	
	963	Stop group 1 sudden stop selection error	The setting range of "stop group 1 sudden stop selection" in detail parameter 2 is out of the setting range.	
	964	Stop group 2 sudden stop selection error	The setting range of "stop group 2 sudden stop selection" in detail parameter 2 is out of the setting range.	
	965	Stop group 3 sudden stop selection error	The setting range of "stop group 3 sudden stop selection" in detail parameter 2 is out of the setting range.	
	966	Outside allowable circular interpolation error width range	The setting range of the "allowable circular interpolation error width range" in detail parameter 2 is out of the setting range.	
	967	External start selection error	The setting range of "external start function selection" in detail parameter 2 is out of the setting range.	
	971	Path control mode error	The "near pass mode selection for path control" setting in detail parameter 2 is out of the setting range.	
	980	Zero point return method error	The setting range of the "zero point return method" zero point return basic parameter is out of the setting range.	
	981	Zero point return direction error	The setting range of the "zero point return direction" zero point return basic parameter is out of the setting range.	
	982	Zero point address setting error	The setting range of the "zero point address" zero point return basic parameter is out of the setting range.	

Relevant buffer memory address			Setting range (Setting given in sequence program)	Remedy
Axis 1	Axis 2	Axis 3		
51	201	351	0, 1, 2, 3	Change the setting to within the setting range and turn OFF then ON the PLC READY signal (Y1D).
52	202	352	0, 1	
53	203	353	1 to 100	
54	204	354	(One-word type) 1 to 65535	
55	205	355	(Two-word type) 1 to 8388608	
56	206	356	0, 1	
57	207	357	0, 1	
58	208	358	0, 1	
60	210	360	(In standard mode) 1 to 100000	
61	211	361	(In stepping motor mode) —	
62	212	362	0, 1, 2	
66	216	366	0: Positioning address pass mode 1: Near pass mode	
70	220	370	0, 1, 2, 3, 4, 5	
71	221	371	0, 1	
72	222	372	(In standard mode) • [mm] [inch] [pulse] -2147483648 to 2147483647	
73	223	373	(In stepping motor mode) • [mm] [inch] [pulse] -134217728 to 134217727 • [degree] 0 to 35999999	

Division of error	Error code	Error name	Description	Action at occurrence of error
Parameter	983	Zero point return speed error	The setting range of the "zero point return speed" zero point return basic parameter is out of the setting range.	The AD75 READY signal (X0) is not turned OFF.
	984	Creep speed error	The setting range of the "creep speed" zero point return basic parameter is out of the setting range.	
	985	Zero point return retry error	The setting range of the "zero point return retry" zero point return basic parameter is out of the setting range.	
	991	Zero point return torque limit value	The setting range of the "zero point return torque limit value" zero point return detail parameter is out of the setting range.	
	992	Setting for the movement amount after near-point dog ON error	The setting range of the "setting for the movement amount after near-point dog ON" zero point return detail parameter is out of the setting range.	
	993	Zero point return acceleration selection error	The setting range of the "zero point return acceleration time selection" zero point return detail parameter is out of the setting range.	
	994	Zero point return deceleration selection error	The setting range of the "zero point return deceleration time selection" zero point return detail parameter is out of the setting range.	
	997	Speed selection at zero point shift error	The setting range of the "speed designation during zero point shift" zero point return detail parameter is out of the setting range.	
	999	Flash ROM sum check error	Flash ROM writing is terminated erroneously.	

If a reserved error code is displayed, unnecessary data is stored in the buffer memory not described in the manual.

If a reserved error occurs, write the following data to the designated buffer memory.

Error code	Setting data	Relevant buffer memory address		
		Axis 1	Axis 2	Axis 3
934	0	32	182	332
935	1	33	183	333
936	3	34	184	334
937	0	35	185	335
996	1	87	237	387
970	0	64, 65	214, 215	364, 365

	Relevant buffer memory address			Setting range (Setting given in sequence program)	Remedy
	Axis 1	Axis 2	Axis 3		
74 75	224 225	374 375	(In standard mode) 1 to 1000000 [pulse/s] 1 to 600000000 [mm/min, etc.] (In stepping motor mode) 1 to 62500 [pulse/s] 1 to 37500000 [mm/min, etc.]	Change the setting to within the setting range and turn OFF then ON the PLC READY signal (Y1D).	
76 77	226 227	376 377	(In standard mode) 1 to 1000000 [pulse/s] 1 to 600000000 [mm/min, etc.] (In stepping motor mode) 1 to 62500 [pulse/s] 1 to 37500000 [mm/min, etc.]		
78	228	378	0, 1		
86	236	386	1 to 300		
80 81	230 231	380 381	(In standard mode) 0 to 2147483647 (In stepping motor mode) 0 to 134217727		
82	232	382	0, 1, 2, 3		
83	233	383	0, 1, 2, 3		
88	238	388	0, 1		
—	—	—	—		<ul style="list-style-type: none"> • Write the flash ROM again. • If the same error persists, replace the module.

14.3 List of warnings

The following table shows the warning details and remedies when warnings occur.

Division of warning	Warning code	Warning name	Description	Action at occurrence of warning
—	000	(Normal)	—	—
	051	Illegal movement amount change during speed/position changeover control	The setting of the speed/position changeover control movement amount change register is out of the setting range.	The action follows the positioning address and movement amount specified in the positioning data.
	052	Illegal new speed value	The new speed value setting is out of the setting range during JOG operation.	Clamped at the maximum limit in the setting range.
Common	100	Start during operation	A start request is issued when the axis is busy.	Operation continues.
	101	Current value change when BUSY	The current value is changed when the axis is busy.	The current value change request is ignored.
	102	Deviation counter clear request	A deviation counter clear request is issued when the axis is busy.	The deviation counter clear request is ignored.
	104	Restart not possible	A restart command is issued in other than the "stopped" axis status.	Operation continues.
	105	Illegal target axis	The target axis of reading/writing is out of the setting range.	<ul style="list-style-type: none"> • The warning is for the reference axis. • Reading/writing is not made.
	106	Illegal positioning data No.	The positioning data number to be read/written is out of the setting range.	<ul style="list-style-type: none"> • The warning is for the target axis. • Reading/writing is not made.
	107	Illegal writing pattern	The writing pattern to be read/written is out of the setting range.	<ul style="list-style-type: none"> • The warning is for the target axis. • Reading/writing is not made.
	108	Illegal flash ROM writing	A flash ROM writing request is issued when AD75 READY (X0) is OFF.	<ul style="list-style-type: none"> • The warning is for axis 1. • The flash ROM is not written.
	109	Writing when BUSY	A request is issued when the axis is busy.	The warning is for the target axis of the writing request.
111	In PLC READY	A request to write the flash ROM is issued when PLC READY is ON (during request to teach).	The warning is for axis 1.	

	Relevant buffer memory address			Setting range (Setting given in sequence program)	Remedy				
	Axis 1	Axis 2	Axis 3						
	—	—	—	—	—				
	1164 1165	1214 1215	1264 1265	<In standard mode> 0 to 2147483647 [pulses, etc.] <In stepping motor mode> 0 to 134217727 [pulses, etc.]	Correct the setting in the speed/position changeover control movement amount change register to within the setting range.				
	1156 1157	1206 1207	1256 1257	<In standard mode> 0 to 1000000 [pulse/s] 0 to 600000000 [mm/min, etc.] <In stepping motor mode> 0 to 62500 [pulse/s] 0 to 37500000 [mm/min, etc.]	Change the new speed value setting to within the setting range.				
	—	—	—	—	Correct the start request issuance timing.				
	1150	1200	1250	<Positioning start No.> 9003: Current value change	Do not change the current value during operation of the axis. (Refer to section 9.2.10)				
	—	—	—	—	Do not reset the deviation counter during axis operation. (Refer to Chapter 8)				
	1152	1202	1252	<Restart command> 1: Restart	Correct the start request issuance timing. (Refer to section 6.5.5) (Do not issue a restart command in other than the “stopped” axis operation status.)				
	1103			<Target axis> 1: Axis 1, 2: Axis 2, 3: Axis 3, 4: Interpolation in axis 1 and axis 2, 5: Interpolation in axis 2 and axis 3, 6: Interpolation in axis 3 and axis 1.	Set a value within the setting range.				
	1104			<Positioning data No.> 1 to 600	Set a value within the setting range.				
	1105			<table border="1"> <tr> <td><Write pattern> <Upper order> 00_H to 07_H</td> <td><Write pattern> <Lower order> 00_H to 0F_H</td> </tr> <tr> <td colspan="2">Refer to section “5.7.1 System control data.”</td> </tr> </table>	<Write pattern> <Upper order> 00 _H to 07 _H	<Write pattern> <Lower order> 00 _H to 0F _H	Refer to section “5.7.1 System control data.”		Set a value within the setting range.
<Write pattern> <Upper order> 00 _H to 07 _H	<Write pattern> <Lower order> 00 _H to 0F _H								
Refer to section “5.7.1 System control data.”									
	1138			<Flash ROM write request> 1: Flash ROM write request	—				
	Target axis	<table border="1"> <tr> <td><Target axis> 1, 2, 3, 4, 5, 6</td> </tr> <tr> <td><Read/write request> 2: Write request</td> </tr> </table>			<Target axis> 1, 2, 3, 4, 5, 6	<Read/write request> 2: Write request	A write request is issued when the axis is not busy. (Refer to section 12.6.4)		
<Target axis> 1, 2, 3, 4, 5, 6									
<Read/write request> 2: Write request									
1103									
Read/write request									
	1106	None (The write request issued in the teach mode is responded as soon as the PLC READY signal (Y1D) is turned OFF.)							
Same as warning code 109									

Division of warning	Warning code	Warning name	Description	Action at occurrence of warning
Common	112	Illegal override value	A value outside the range from 1 to 300 is specified as an override value.	<ul style="list-style-type: none"> Setting "0": Controlled to 100. "301" or larger setting: Controlled to 300.
	113	Outside new torque value range	A value outside the range from 1 to 500 is specified as a new torque value.	Torque change is not carried out.
	114	Below bias speed	The command speed is smaller than the starting bias speed.	Operation is made at the bias speed at start.
	115	Illegal No. of read/write data	The No. of read/write data of positioning data No. 101 to 600 is outside the range from 1 to 100.	<ul style="list-style-type: none"> The warning is for the target axis. Reading/writing is not made.
JOG	300	Speed change during deceleration	A speed change request is issued during deceleration and stop caused by turned OFF of the JOG start signal.	Speed change is not made.
	301	JOG speed limit value	The new speed value in JOG operation exceeds the JOG speed limit value.	<ul style="list-style-type: none"> If the JOG speed limit value is exceeded, JOG operation continues at the JOG speed limit value. The "in speed limit flag" is turned ON while the JOG speed limit is active.
Manual pulse generator	401	Outside manual pulse generator input magnification	The manual pulse generator 1 pulse input magnification is "0" or equal to or larger than "101."	<ul style="list-style-type: none"> Input magnification ≥ 101: 100 Input magnification "0": 1
	402	Manual pulse generator selection 0	The manual pulse generator enable flag is set when "manual pulse generator selection" in detail parameter 1 is set at "0."	Failure to start manual pulse generator operation

Relevant buffer memory address			Setting range (Setting given in sequence program)	Remedy
Axis 1	Axis 2	Axis 3		
1159	1209	1259	<Positioning operation speed override> 1 to 300	Set a value within the setting range.
1176	1226	1276	<New torque value> 1 to [torque limit setting value]	
24	174	324	<Torque limit setting> 1 to 500	
Refer to section "5.3 List of positioning data" for the command speed.			<Command speed, bias speed at start> <In standard mode> 0 to 1000000 [pulse/s] 0 to 600000000 [mm/min, etc.] <In stepping motor mode> 0 to 62500 [pulse/s] 0 to 37500000 [mm/min, etc.]	Change the command speed and bias speed at start so that the command speed is equal to or larger than the bias speed at start.
Bias speed at start				
12, 13	162, 163	312, 313		
5102			<No. of read/write data> 1 to 100	Change the setting to within the setting range and issue a read/write request. (Refer to section 7.2)
1158	1208	1258	<Speed change request> 1: Speed change request	Do not change the JOG speed during deceleration caused by turned OFF of the JOG start signal.
New speed value			<New speed value or JOG speed limit value> <In standard mode> 0 to 1000000 [pulse/s] 0 to 600000000 [mm/min, etc.] <In stepping motor mode> 0 to 62500 [pulse/s] 0 to 37500000 [mm/min, etc.] [In case of speed change value, the minimum setting is "0."]	Change the setting to within the setting range.
1156	1206	1256		
1157	1207	1257		
JOG speed limit value				
48, 49	198, 199	348, 349		
1168	1218	1268	<Manual pulse generator 1 pulse input magnification> 1 to 100	Change the manual pulse generator 1 pulse input magnification to within the setting range.
1169	1219	1269		
Manual pulse generator enable flag			<Manual pulse generator enable flag> 0: Operation using the manual pulse generator is not enabled. 1: Operation using the manual pulse generator is enabled. <Manual pulse generator selection> 0: Manual pulse generator operation ignored 1: Manual pulse generator connected to axis 1 is used. 2: Manual pulse generator connected to axis 2 is used. 3: Manual pulse generator connected to axis 3 is used.	<ul style="list-style-type: none"> • Change the manual pulse generator enable flag to prohibition. • Change the manual pulse generator selection setting to a value between 1 and 3.
1167	1217	1267		
Manual pulse generator selection				
29	179	329		

Division of warning	Warning code	Warning name	Description	Action at occurrence of warning	
Positioning operation	500	Deceleration and stop speed change	A speed change request is issued during deceleration and stop.	Speed change is not carried out.	
	501	Speed limit value over	The new speed value given during operation exceeds the speed limit value.	<ul style="list-style-type: none"> • The speed is controlled to the "speed limit value." • The "in speed limit flag" is turned ON. 	
	503	M code ON signal ON start	The M code ON signal is turned ON during execution of positioning data.	Execution of positioning data continues.	
	505	No operation end setting	In the block start positioning operation, the setting at 50th point in the positioning start data indicates continuation.	Operation is terminated.	
	506	FOR to NEXT nesting structure	There is a nested set of FOR and NEXT.	Operation continues.	
	508	Speed/position changeover signal ON during acceleration	The changeover signal is turned ON during acceleration under speed/position changeover control.		
	509	Insufficient remaining distance	The deceleration distance for a speed change request is insufficient.	A speed change occurs at the nearest value. (However, the request is ignored if the operation pattern is continuous path control.)	
	511	Invalid step start information	<p>"2: Restart" is specified for the step start information in the "in step wait" axis operation status.</p> <p>"1: Step continue" or "2: Restart" is specified in the step start information in the "step error occurring," "error occurring," "waiting," or "stopped" axis operation status.</p>	Step operation does not start.	
	512	Illegal external start function	The "external start function selection" setting in detail parameter 2 exceeds the setting range.	Nothing occurs in response to the external start signal.	
	513	Insufficient movement amount	There is no movement amount necessary for automatic deceleration.	Immediate stop after the positioning address is reached	
514	Outside command speed range	The command speed exceeds the speed limit value.	<ul style="list-style-type: none"> • The command speed is controlled to the "speed limit value." • The "in speed limit flag" is set. 		
System control data	900	Illegal clock data setting	The clock data is written when the clock data setting is out of the setting range.	The clock data is not written.	

	Relevant buffer memory address			Setting range (Setting given in sequence program)	Remedy
	Axis 1	Axis 2	Axis 3		
	1158	1208	1258	<Speed change request> 1: Speed change request	Do not change the speed during deceleration or stoppage caused by a stop command or during automatic deceleration under position control.
	New speed value			<New speed value, speed limit value> <In standard mode> 1 to 1000000 [pulse/s] 1 to 600000000 [mm/min, etc.] <In stepping motor mode> 1 to 62500 [pulse/s] 1 to 37500000 [mm/min, etc.] [In case of new speed value, the minimum setting is "0."]]	Change the new speed to a value within the range from 0 to the "speed limit value."
	1156	1206	1256		
	1157	1207	1257		
	Speed limit value				
	6, 7	156, 157	306, 307		
	1153	1203	1253	<M code OFF request> 1: The M code ON signal is turned OFF.	Correct the ON/OFF timing of the "M code OFF request." (Refer to section 12.6.3)
	Refer to section "5.3 List of positioning data."			<Operation pattern> 00: Positioning complete 01: Continuous positioning control 11: Continuous path control	Specify the end of operation at the 50th point. (Refer to Chapter 10)
	—	—	—	—	Reduce the FOR to NEXT nesting structure to one. (Refer to section 10.3.9)
	—	—	—	—	Do not turn ON the speed/position changeover signal during acceleration. (Refer to section 9.2.9)
	—	—	—	—	Issue a speed change request at a position where the sufficient remaining distance is left.
	1174	1224	1274	<Step start information> 0: End of reception of step start 1: Step continue 2: Restart	Do not specify "1: Step continue" in the "step waiting" axis status. Do not specify "1: Step continue" or "2: Restart" in the "step error occurring," "error occurring," "waiting," or "stopped" axis operation status.
	62	212	362	<External start function selection> 0, 1, 2	Change "external start function selection" in detail parameter 2 to within the setting range.
	Refer to section "5.3 List of positioning data."			—	Change the positioning data to an address or movement amount sufficient for deceleration.
	Refer to section "5.3 List of positioning data" for the command speed.			<Command speed, speed limit value> <In standard mode> 1 to 1000000 [pulse/s] 1 to 600000000 [mm/min, etc.] <In stepping motor mode> 1 to 62500 [pulse/s] 1 to 37500000 [mm/min, etc.]	Change the command speed to within the setting range.
	Speed limit value				
	6, 7	156, 157	306, 307		
	1100 1101			Hours: 00 to 23 Minutes: 00 to 59 Seconds: 00 to 59	Enter settings within the setting range in BCD codes.

14.4 Start during error history

If an error occurs when starting, all the data in the buffer memory start history area (address: 462 to 541) is copied to the start during error history area (addresses: 543 to 622).

The data stored in the start during error history area is lost when the power is turned OFF.

(When the power is turned ON, a "0" is stored in the start during error history.)

Up to 16 start history items from turning the power ON can be stored in the start during error history area.

(The previous history items are cleared in order from No. 1 when the No. of history items is exceeded.)

The start during error history can be monitored with a peripheral device.

Refer to the AD75 Software Package Operating Manual for details on operation of the peripheral device.

< Example of display on the peripheral device >

No.	Axis	Start	Type	Time	Judgment
1	1	External	100	21:34:56.7	OK
2	2	PC	Manual pulse generator	21:43:12.3	OK
3	2	PC	JOG	21:43:34.4	201
4	1	External	Restart 100	21:43:54.8	OK
5	3	Peripheral	101	10:18:03.7	201

APPENDICES

Appendix 1 External dimension drawing	Appendix- 2
Appendix 2 Format sheets	Appendix- 4
Appendix 2.1 Positioning module operation chart.....	Appendix- 4
Appendix 2.2 Parameter setting value entry table	Appendix- 6
Appendix 2.3 Positioning data setting value entry table [data No. to].....	Appendix- 12
Appendix 3 Positioning data (No. 1 to 100), List of buffer memory addresses	Appendix- 13
Appendix 4 Connection examples with servo amplifiers manufactured by MITSUBISHI Electric Corporation	Appendix- 16
Appendix 4.1 Connection example of A1SD75/AD75 and MR-H□A (Differential driver (Open collector))	Appendix- 16
Appendix 4.2 Connection example of A1SD75/AD75 and MR-J2/J2S-□A (Differential driver (Open collector))	Appendix- 17
Appendix 4.3 Connection example of A1SD75/AD75 and MR-C□A (Differential driver (Open collector))	Appendix- 18
Appendix 5 Connection examples with stepping motors manufactured by ORIENTALMOTOR Co., Ltd.	Appendix- 19
Appendix 5.1 Connection example of A1SD75/AD75 and VEXTA UPD (Open collector).....	Appendix- 19
Appendix 6 Connection examples with servo amplifiers manufactured by Matsushita Electric Industrial Co., Ltd.....	Appendix- 20
Appendix 6.1 Connection example of A1SD75/AD75 and MINAS-A series (Differential driver).....	Appendix- 20
Appendix 7 Connection examples with servo amplifiers manufactured by SANYO DENKI Co., Ltd.	Appendix- 21
Appendix 7.1 Connection example of A1SD75/AD75 and PYO series (Differential driver).....	Appendix- 21
Appendix 8 Connection examples with servo amplifiers manufactured by YASKAWA Electric Corporation	Appendix- 22
Appendix 8.1 Connection example of A1SD75/AD75 and Σ -II series (Differential driver).....	Appendix- 22
Appendix 9 Comparisons with conventional positioning modules.....	Appendix- 23
Appendix 9.1 Comparisons with AD71 (S1), AD71S2 (A1SD71S2) models	Appendix- 23
Appendix 9.2 Comparisons with A1SD75P1/A1SD75P2/A1SD75P3, and AD75P1/ AD75P2/ AD75P3 models	Appendix- 24
Appendix 9.3 Comparisons with old versions of A1SD75P1-S3/A1SD75P2-S3/ A1SD75P3-S3, and AD75P1-S3/AD75P2-S3/AD75P3-S3 models.....	Appendix- 25
Appendix 10 MELSEC Explanation of positioning terms	Appendix- 26
Appendix 11 Positioning control troubleshooting	Appendix- 46
Appendix 12 List of buffer memory addresses	Appendix- 52

Appendix 1 External dimension drawing

(1) AD75P1-S3/AD75P2-S3/AD75P3-S3

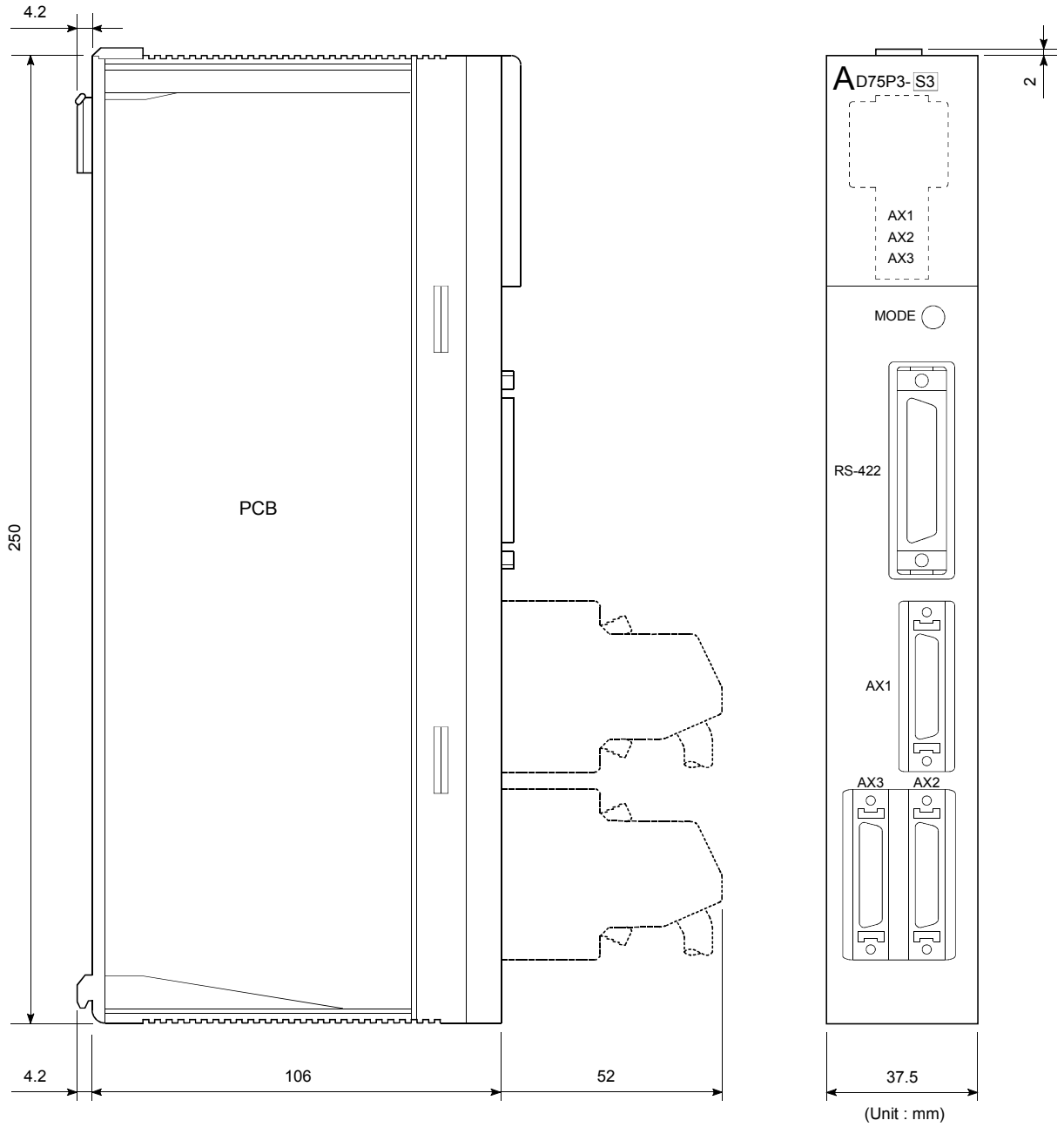

(2) A1SD75P2-S3/A1SD75P2-S3/A1SD75P3-S3

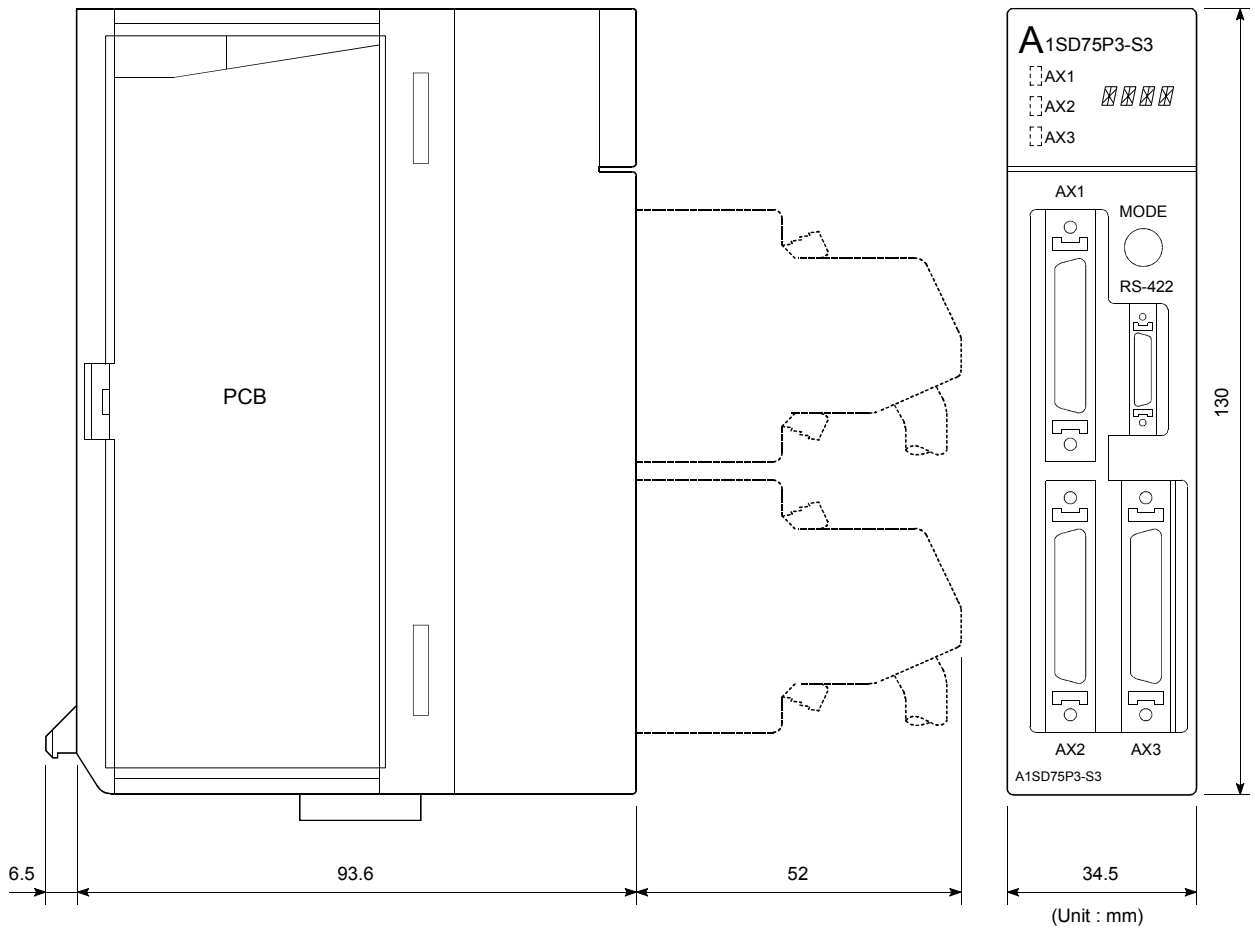

Appendix 2.2 Parameter setting value entry table

Item		Setting range			
		mm	inch	degree	pulse
Basic parameters 1	Pr.1 Unit setting	0	1	2	3
	Pr.2 No. of pulses per rotation (Ap)	1 to 65535 pulse			
	Pr.3 Movement amount per rotation (Al)	1 to 65535 $\times 10^{-1}\mu\text{m}$	1 to 65535 $\times 10^{-5}\text{inch}$	1 to 65535 $\times 10^{-5}\text{degree}$	1 to 65535 pulse
	Pr.4 Unit magnification (Am)	1: 1-fold, 10: 10-fold, 100: 100-fold, 1000: 1000-fold			
	Pr.5 Pulse output mode	0: PULSE/SIGN mode, 1: CW/CCW mode, 2: A phase/B phase (multiple of 4), 3: A phase/B phase (multiple of 1)			
	Pr.6 Rotation direction setting	0: Current value increment with forward run pulse output 1: Current value increment with reverse run pulse output			
Basic parameters 2	Pr.7 Speed limit value	1 to 600000000 $\times 10^{-2}\text{mm/min}$	1 to 600000000 $\times 10^{-3}\text{mm/min}$	1 to 600000000 $\times 10^{-3}\text{degree/min}$	1 to 600000000 pulse
	Pr.8 Acceleration time 0	1 to 65535ms/1 to 8388608ms			
	Pr.9 Deceleration time 0				
	Pr.10 Bias speed at start	0 to 600000000 $\times 10^{-2}\text{mm/min}$	0 to 600000000 $\times 10^{-3}\text{inch/min}$	0 to 600000000 $\times 10^{-3}\text{degree/min}$	0 to 1000000 pulse/s
	Pr.11 Stepping motor mode selection	0: Standard mode, 1: Stepping motor mode			
Detailed parameters 1	Pr.12 Backlash compensation amount	1 to 65535 $\times 10^{-1}\mu\text{m}$	1 to 65535 $\times 10^{-5}\text{inch}$	1 to 65535 $\times 10^{-5}\text{degree}$	1 to 65535 pulse
	Pr.13 Software stroke limit upper limit value	-2147483648 to 2147483647 $\times 10^{-1}\mu\text{m}$	-2147483648 to 2147483647 $\times 10^{-5}\text{inch}$	0 to 35999999 $\times 10^{-5}\text{degree}$	-2147483648 to 2147483647 pulse
	Pr.14 Software stroke limit lower limit value				
	Pr.15 Software stroke limit selection	0: Apply software stroke limit on current feed value 1: Apply software stroke limit on machine feed value			
	Pr.16 Software stroke limit valid/invalid setting	0: Software stroke limit invalid during JOG operation and manual pulse generator operation 1: Software stroke limit valid during JOG operation and manual pulse generator operation			
	Pr.17 Command in-position width	1 to 32767000 $\times 10^{-1}\mu\text{m}$	1 to 32767000 $\times 10^{-5}\text{inch}$	1 to 32767000 $\times 10^{-5}\text{degree}$	1 to 32767 pulse
	Pr.18 Torque limit setting value	1 to 500%			
	Pr.19 M code ON signal output timing	0: WITH mode, 1: AFTER mode			
	Pr.20 Speed changeover mode	0: Standard speed changeover mode 1: Front-loading speed changeover mode			
	Pr.21 Interpolation speed designation method	0: Composite speed, 1: Reference axis speed			
Pr.22 Current feed value during speed control	0: Do not update current feed value, 1: Update current feed value 2: Clear current feed value to zero				

	Initial value	Axis 1	Axis 2	Axis 3	Remarks
	3				
	20000				
	20000				
	1				
	1				
	0				
	200000				
	1000				
	1000				
	0				
	0				
	0				
	2147483647				
	-2147483648				
	0				
	0				
	100				
	300				
	0				
	0				
	0				
	0				

Item		Setting range			
		mm	inch	degree	pulse
Detailed parameters 1	Pr.23 Manual pulse generator selection	0: Ignore manual pulse generator operation 1: Use manual pulse generator 1 (control using manual pulse generator connected to axis 1) 2: Use manual pulse generator 2 (control using manual pulse generator connected to axis 2) 3: Use manual pulse generator 3 (control using manual pulse generator connected to axis 3)			
	Pr.24 Logic selection for pulse output to the drive unit	0: Positive logic, 1: Negative logic			
	Pr.25 Size selection for acceleration/ deceleration time	0: 1-word type (1 to 65535ms), 1: 2-word type (1 to 8388608ms)			
Detailed parameters 2	Pr.26 Acceleration time 1	0 to 65535ms/1 to 8388608ms			
	Pr.27 Acceleration time 2				
	Pr.28 Acceleration time 3				
	Pr.29 Deceleration time 1				
	Pr.30 Deceleration time 2				
	Pr.31 Deceleration time 3				
	Pr.32 JOG speed limit value	1 to 600000000 × 10 ⁻² mm/min	1 to 600000000 × 10 ⁻³ inch/min	1 to 600000000 × 10 ⁻³ degree/min	1 to 600000000 pulse
	Pr.33 JOG operation acceleration time selection	0 to 3			
	Pr.34 JOG operation deceleration time selection				
	Pr.35 Acceleration/deceleration process selection	0: Automatic trapezoidal acceleration/deceleration process 1: S-curve acceleration/deceleration process			
	Pr.36 S-curve ratio	1 to 100%			
	Pr.37 Sudden stop deceleration time	1 to 65535ms/1 to 8388608ms			
	Pr.38 Stop group 1 sudden stop selection	0: Normal deceleration stop, 1: Sudden stop			
	Pr.39 Stop group 2 sudden stop selection				
	Pr.40 Stop group 3 sudden stop selection				
	Pr.41 Positioning complete signal output time	0 to 65535ms			
	Pr.42 Allowable circular interpolation error width	1 to 100000 × 10 ⁻¹ μm	1 to 100000 × 10 ⁻⁵ inch	1 to 100000 × 10 ⁻⁵ degree	1 to 100000 pulse
	Pr.43 External start function selection	0: External speed change request, 1: External speed change request, 2: Skip request			
Pr.44 Near pass mode selection for path control	0: Positioning address pass mode, 1: Near pass mode				

	Initial value	Axis 1	Axis 2	Axis 3	Remarks
	Axis 1: 1, Axis 2: 2, Axis 3: 3				
	0				
	0				
	1000				
	1000				
	1000				
	1000				
	1000				
	1000				
	1000				
	20000				
	0				
	0				
	0				
	100				
	1000				
	0				
	0				
	0				
	300				
	100				
	0				
	0				

Item		Setting range			
		mm	inch	degree	pulse
Zero point return basic parameters	Pr.45 Zero point return method	0: Near-point dog method, 1: Stopper stop method 1) 2: Stopper stop method 2), 3: Stopper stop method 3) 4: Count method 1), 5: Count method 2)			
	Pr.46 Zero point return direction	0: Positive direction (address increment direction) 1: Negative direction (address decrement direction)			
	Pr.47 Zero point address	-2147483648 to 2147483647 × 10 ⁻¹ μm	-2147483648 to 2147483647 × 10 ⁻⁵ inch	0 to 35999999 × 10 ⁻⁵ degree	-2147483648 to 2147483647 pulse/s
	Pr.48 Zero point return speed	1 to 600000000 × 10 ⁻² mm/min	1 to 600000000 × 10 ⁻³ inch/min	1 to 600000000 × 10 ⁻³ degree/min	1 to 1000000 pulse/s
	Pr.49 Creep speed				
	Pr.50 Zero point return retry	0: Do not retry zero point return with limit switch 1: Retry zero point return with limit switch			
Zero point return detailed parameters	Pr.51 Zero point return dwell time	0 to 65535ms			
	Pr.52 Setting for the movement amount after near-point dog ON	0 to 2147483647 × 10 ⁻¹ μm	0 to 2147483647 × 10 ⁻⁵ inch	0 to 2147483647 × 10 ⁻⁵ degree	0 to 2147483647 pulse
	Pr.53 Zero point return acceleration time selection	0 to 3			
	Pr.54 Zero point return deceleration time selection				
	Pr.55 Zero point shift amount	-2147483648 to 2147483647 × 10 ⁻¹ μm	-2147483648 to 2147483647 × 10 ⁻⁵ inch	0 to 35999999 × 10 ⁻⁵ degree	-2147483648 to 2147483647 pulse/s
	Pr.56 Zero point return torque limit value	0 to 300%			
	Pr.57 Speed designation during zero point shift	0: Zero point return speed, 1: Creep speed			
	Pr.58 Dwell time during zero point return retry	0 to 65535ms			

	Initial value	Axis 1	Axis 2	Axis 3	Remarks
	0				
	0				
	0				
	1				
	1				
	0				
	0				
	0				
	0				
	0				
	0				
	300				
	0				
	0				

Appendix 2.3 Positioning data setting value entry table [data No. to]

Data	Axis								
	Da.1 Operation pattern	Da.2 Control method	Da.3 Accelera- tion time No.	Da.4 Decelera- tion time No.	Da.5 Positioning address/ movement amount	Da.6 Arc address	Da.7 Command speed	Da.8 Dwell time	Da.9 M code
1									
2									
3									
4									
5									
6									
7									
8									
9									
0									
1									
2									
3									
4									
5									
6									
7									
8									
9									
0									
1									
2									
3									
4									
5									
6									
7									
8									
9									
0									
1									
2									
3									
4									
5									
6									
7									
8									
9									
0									
1									
2									
3									
4									
5									
6									
7									
8									
9									
0									

Appendix 3 Positioning data (No. 1 to 100)
List of buffer memory addresses

(1) For axis 1

Data No.	Positioning identifier	M code	Dwell time	Command speed		Positioning address		Arc data	
				Low-order	High-order	Low-order	High-order	Low-order	High-order
1	1300	1301	1302	1304	1305	1306	1307	1308	1309
2	1310	1311	1312	1314	1315	1316	1317	1318	1319
3	1320	1321	1322	1324	1325	1326	1327	1328	1329
4	1330	1331	1332	1334	1335	1336	1337	1338	1339
5	1340	1341	1342	1344	1345	1346	1347	1348	1349
6	1350	1351	1352	1354	1355	1356	1357	1358	1359
7	1360	1361	1362	1364	1365	1366	1367	1368	1369
8	1370	1371	1372	1374	1375	1376	1377	1378	1379
9	1380	1381	1382	1384	1385	1386	1387	1388	1389
10	1390	1391	1392	1394	1395	1396	1397	1398	1399
11	1400	1401	1402	1404	1405	1406	1407	1408	1409
12	1410	1411	1412	1414	1415	1416	1417	1418	1419
13	1420	1421	1422	1424	1425	1426	1427	1428	1429
14	1430	1431	1432	1434	1435	1436	1437	1438	1439
15	1440	1441	1442	1444	1445	1446	1447	1448	1449
16	1450	1451	1452	1454	1455	1456	1457	1458	1459
17	1460	1461	1462	1464	1465	1466	1467	1468	1469
18	1470	1471	1472	1474	1475	1476	1477	1478	1479
19	1480	1481	1482	1484	1485	1486	1487	1488	1489
20	1490	1491	1492	1494	1495	1496	1497	1498	1499
21	1500	1501	1502	1504	1505	1506	1507	1508	1509
22	1510	1511	1512	1514	1515	1516	1517	1518	1519
23	1520	1521	1522	1524	1525	1526	1527	1528	1529
24	1530	1531	1532	1534	1535	1536	1537	1538	1539
25	1540	1541	1542	1544	1545	1546	1547	1548	1549
26	1550	1551	1552	1554	1555	1556	1557	1558	1559
27	1560	1561	1562	1564	1565	1566	1567	1568	1569
28	1570	1571	1572	1574	1575	1576	1577	1578	1579
29	1580	1581	1582	1584	1585	1586	1587	1588	1589
30	1590	1591	1592	1594	1595	1596	1597	1598	1599
31	1600	1601	1602	1604	1605	1606	1607	1608	1609
32	1610	1611	1612	1614	1615	1616	1617	1618	1619
33	1620	1621	1622	1624	1625	1626	1627	1628	1629
34	1630	1631	1632	1634	1635	1636	1637	1638	1639
35	1640	1641	1642	1644	1645	1646	1647	1648	1649
36	1650	1651	1652	1654	1655	1656	1657	1658	1659
37	1660	1661	1662	1664	1665	1666	1667	1668	1669
38	1670	1671	1672	1674	1675	1676	1677	1678	1679
39	1680	1681	1682	1684	1685	1686	1687	1688	1689
40	1690	1691	1692	1694	1695	1696	1697	1698	1699
41	1700	1701	1702	1704	1705	1706	1707	1708	1709
42	1710	1711	1712	1714	1715	1716	1717	1718	1719
43	1720	1721	1722	1724	1725	1726	1727	1728	1729
44	1730	1731	1732	1734	1735	1736	1737	1738	1739
45	1740	1741	1742	1744	1745	1746	1747	1748	1749
46	1750	1751	1752	1754	1755	1756	1757	1758	1759
47	1760	1761	1762	1764	1765	1766	1767	1768	1769
48	1770	1771	1772	1774	1775	1776	1777	1778	1779
49	1780	1781	1782	1784	1785	1786	1787	1788	1789
50	1790	1791	1792	1794	1795	1796	1797	1798	1799
51	1800	1801	1802	1804	1805	1806	1807	1808	1809
52	1810	1811	1812	1814	1815	1816	1817	1818	1819
53	1820	1821	1822	1824	1825	1826	1827	1828	1829
54	1830	1831	1832	1834	1835	1836	1837	1838	1839
55	1840	1841	1842	1844	1845	1846	1847	1848	1849
56	1850	1851	1852	1854	1855	1856	1857	1858	1859
57	1860	1861	1862	1864	1865	1866	1867	1868	1869
58	1870	1871	1872	1874	1875	1876	1877	1878	1879
59	1880	1881	1882	1884	1885	1886	1887	1888	1889
60	1890	1891	1892	1894	1895	1896	1897	1898	1899
61	1900	1901	1902	1904	1905	1906	1907	1908	1909
62	1910	1911	1912	1914	1915	1916	1917	1918	1919
63	1920	1921	1922	1924	1925	1926	1927	1928	1929
64	1930	1931	1932	1934	1935	1936	1937	1938	1939
65	1940	1941	1942	1944	1945	1946	1947	1948	1949
66	1950	1951	1952	1954	1955	1956	1957	1958	1959
67	1960	1961	1962	1964	1965	1966	1967	1968	1969
68	1970	1971	1972	1974	1975	1976	1977	1978	1979
69	1980	1981	1982	1984	1985	1986	1987	1988	1989
70	1990	1991	1992	1994	1995	1996	1997	1998	1999
71	2000	2001	2002	2004	2005	2006	2007	2008	2009
72	2010	2011	2012	2014	2015	2016	2017	2018	2019
73	2020	2021	2022	2024	2025	2026	2027	2028	2029
74	2030	2031	2032	2034	2035	2036	2037	2038	2039
75	2040	2041	2042	2044	2045	2046	2047	2048	2049
76	2050	2051	2052	2054	2055	2056	2057	2058	2059
77	2060	2061	2062	2064	2065	2066	2067	2068	2069
78	2070	2071	2072	2074	2075	2076	2077	2078	2079
79	2080	2081	2082	2084	2085	2086	2087	2088	2089
80	2090	2091	2092	2094	2095	2096	2097	2098	2099
81	2100	2101	2102	2104	2105	2106	2107	2108	2109
82	2110	2111	2112	2114	2115	2116	2117	2118	2119
83	2120	2121	2122	2124	2125	2126	2127	2128	2129
84	2130	2131	2132	2134	2135	2136	2137	2138	2139
85	2140	2141	2142	2144	2145	2146	2147	2148	2149
86	2150	2151	2152	2154	2155	2156	2157	2158	2159
87	2160	2161	2162	2164	2165	2166	2167	2168	2169
88	2170	2171	2172	2174	2175	2176	2177	2178	2179
89	2180	2181	2182	2184	2185	2186	2187	2188	2189
90	2190	2191	2192	2194	2195	2196	2197	2198	2199
91	2200	2201	2202	2204	2205	2206	2207	2208	2209
92	2210	2211	2212	2214	2215	2216	2217	2218	2219
93	2220	2221	2222	2224	2225	2226	2227	2228	2229
94	2230	2231	2232	2234	2235	2236	2237	2238	2239
95	2240	2241	2242	2244	2245	2246	2247	2248	2249
96	2250	2251	2252	2254	2255	2256	2257	2258	2259
97	2260	2261	2262	2264	2265	2266	2267	2268	2269
98	2270	2271	2272	2274	2275	2276	2277	2278	2279
99	2280	2281	2282	2284	2285	2286	2287	2288	2289
100	2290	2291	2292	2294	2295	2296	2297	2298	2299

(2) For axis 2

Data No.	Positioning identifier	M code	Dwell time	Command speed		Positioning address		Arc data		Data No.	Positioning identifier	M code	Dwell time	Command speed		Positioning address		Arc data	
				Low-order	High-order	Low-order	High-order	Low-order	High-order					Low-order	High-order	Low-order	High-order	Low-order	High-order
1	2300	2301	2302	2304	2305	2306	2307	2308	2309	51	2800	2801	2802	2804	2805	2806	2807	2808	2809
2	2310	2311	2312	2314	2315	2316	2317	2318	2319	52	2810	2811	2812	2814	2815	2816	2817	2818	2819
3	2320	2321	2322	2324	2325	2326	2327	2328	2329	53	2820	2821	2822	2824	2825	2826	2827	2828	2829
4	2330	2331	2332	2334	2335	2336	2337	2338	2339	54	2830	2831	2832	2834	2835	2836	2837	2838	2839
5	2340	2341	2342	2344	2345	2346	2347	2348	2349	55	2840	2841	2842	2844	2845	2846	2847	2848	2849
6	2350	2351	2352	2354	2355	2356	2357	2358	2359	56	2850	2851	2852	2854	2855	2856	2857	2858	2859
7	2360	2361	2362	2364	2365	2366	2367	2368	2369	57	2860	2861	2862	2864	2865	2866	2867	2868	2869
8	2370	2371	2372	2374	2375	2376	2377	2378	2379	58	2870	2871	2872	2874	2875	2876	2877	2878	2879
9	2380	2381	2382	2384	2385	2386	2387	2388	2389	59	2880	2881	2882	2884	2885	2886	2887	2888	2889
10	2390	2391	2392	2394	2395	2396	2397	2398	2399	60	2890	2891	2892	2894	2895	2896	2897	2898	2899
11	2400	2401	2402	2404	2405	2406	2407	2408	2409	61	2900	2901	2902	2904	2905	2906	2907	2908	2909
12	2410	2411	2412	2414	2415	2416	2417	2418	2419	62	2910	2911	2912	2914	2915	2916	2917	2918	2919
13	2420	2421	2422	2424	2425	2426	2427	2428	2429	63	2920	2921	2922	2924	2925	2926	2927	2928	2929
14	2430	2431	2432	2434	2435	2436	2437	2438	2439	64	2930	2931	2932	2934	2935	2936	2937	2938	2939
15	2440	2441	2442	2444	2445	2446	2447	2448	2449	65	2940	2941	2942	2944	2945	2946	2947	2948	2949
16	2450	2451	2452	2454	2455	2456	2457	2458	2459	66	2950	2951	2952	2954	2955	2956	2957	2958	2959
17	2460	2461	2462	2464	2465	2466	2467	2468	2469	67	2960	2961	2962	2964	2965	2966	2967	2968	2969
18	2470	2471	2472	2474	2475	2476	2477	2478	2479	68	2970	2971	2972	2974	2975	2976	2977	2978	2979
19	2480	2481	2482	2484	2485	2486	2487	2488	2489	69	2980	2981	2982	2984	2985	2986	2987	2988	2989
20	2490	2491	2492	2494	2495	2496	2497	2498	2499	70	2990	2991	2992	2994	2995	2996	2997	2998	2999
21	2500	2501	2502	2504	2505	2506	2507	2508	2509	71	3000	3001	3002	3004	3005	3006	3007	3008	3009
22	2510	2511	2512	2514	2515	2516	2517	2518	2519	72	3010	3011	3012	3014	3015	3016	3017	3018	3019
23	2520	2521	2522	2524	2525	2526	2527	2528	2529	73	3020	3021	3022	3024	3025	3026	3027	3028	3029
24	2530	2531	2532	2534	2535	2536	2537	2538	2539	74	3030	3031	3032	3034	3035	3036	3037	3038	3039
25	2540	2541	2542	2544	2545	2546	2547	2548	2549	75	3040	3041	3042	3044	3045	3046	3047	3048	3049
26	2550	2551	2552	2554	2555	2556	2557	2558	2559	76	3050	3051	3052	3054	3055	3056	3057	3058	3059
27	2560	2561	2562	2564	2565	2566	2567	2568	2569	77	3060	3061	3062	3064	3065	3066	3067	3068	3069
28	2570	2571	2572	2574	2575	2576	2577	2578	2579	78	3070	3071	3072	3074	3075	3076	3077	3078	3079
29	2580	2581	2582	2584	2585	2586	2587	2588	2589	79	3080	3081	3082	3084	3085	3086	3087	3088	3089
30	2590	2591	2592	2594	2595	2596	2597	2598	2599	80	3090	3091	3092	3094	3095	3096	3097	3098	3099
31	2600	2601	2602	2604	2605	2606	2607	2608	2609	81	3100	3101	3102	3104	3105	3106	3107	3108	3109
32	2610	2611	2612	2614	2615	2616	2617	2618	2619	82	3110	3111	3112	3114	3115	3116	3117	3118	3119
33	2620	2621	2622	2624	2625	2626	2627	2628	2629	83	3120	3121	3122	3124	3125	3126	3127	3128	3129
34	2630	2631	2632	2634	2635	2636	2637	2638	2639	84	3130	3131	3132	3134	3135	3136	3137	3138	3139
35	2640	2641	2642	2644	2645	2646	2647	2648	2649	85	3140	3141	3142	3144	3145	3146	3147	3148	3149
36	2650	2651	2652	2654	2655	2656	2657	2658	2659	86	3150	3151	3152	3154	3155	3156	3157	3158	3159
37	2660	2661	2662	2664	2665	2666	2667	2668	2669	87	3160	3161	3162	3164	3165	3166	3167	3168	3169
38	2670	2671	2672	2674	2675	2676	2677	2678	2679	88	3170	3171	3172	3174	3175	3176	3177	3178	3179
39	2680	2681	2682	2684	2685	2686	2687	2688	2689	89	3180	3181	3182	3184	3185	3186	3187	3188	3189
40	2690	2691	2692	2694	2695	2696	2697	2698	2699	90	3190	3191	3192	3194	3195	3196	3197	3198	3199
41	2700	2701	2702	2704	2705	2706	2707	2708	2709	91	3200	3201	3202	3204	3205	3206	3207	3208	3209
42	2710	2711	2712	2714	2715	2716	2717	2718	2719	92	3210	3211	3212	3214	3215	3216	3217	3218	3219
43	2720	2721	2722	2724	2725	2726	2727	2728	2729	93	3220	3221	3222	3224	3225	3226	3227	3228	3229
44	2730	2731	2732	2734	2735	2736	2737	2738	2739	94	3230	3231	3232	3234	3235	3236	3237	3238	3239
45	2740	2741	2742	2744	2745	2746	2747	2748	2749	95	3240	3241	3242	3244	3245	3246	3247	3248	3249
46	2750	2751	2752	2754	2755	2756	2757	2758	2759	96	3250	3251	3252	3254	3255	3256	3257	3258	3259
47	2760	2761	2762	2764	2765	2766	2767	2768	2769	97	3260	3261	3262	3264	3265	3266	3267	3268	3269
48	2770	2771	2772	2774	2775	2776	2777	2778	2779	98	3270	3271	3272	3274	3275	3276	3277	3278	3279
49	2780	2781	2782	2784	2785	2786	2787	2788	2789	99	3280	3281	3282	3284	3285	3286	3287	3288	3289
50	2790	2791	2792	2794	2795	2796	2797	2798	2799	100	3290	3291	3292	3294	3295	3296	3297	3298	3299

(3) For axis 3

Data No.	Positioning identifier	M code	Dwell time	Command speed		Positioning address		Arc data	
				Low-order	High-order	Low-order	High-order	Low-order	High-order
1	3300	3301	3302	3304	3305	3306	3307	3308	3309
2	3310	3311	3312	3314	3315	3316	3317	3318	3319
3	3320	3321	3322	3324	3325	3326	3327	3328	3329
4	3330	3331	3332	3334	3335	3336	3337	3338	3339
5	3340	3341	3342	3344	3345	3346	3347	3348	3349
6	3350	3351	3352	3354	3355	3356	3357	3358	3359
7	3360	3361	3362	3364	3365	3366	3367	3368	3369
8	3370	3371	3372	3374	3375	3376	3377	3378	3379
9	3380	3381	3382	3384	3385	3386	3387	3388	3389
10	3390	3391	3392	3394	3395	3396	3397	3398	3399
11	3400	3401	3402	3404	3405	3406	3407	3408	3409
12	3410	3411	3412	3414	3415	3416	3417	3418	3419
13	3420	3421	3422	3424	3425	3426	3427	3428	3429
14	3430	3431	3432	3434	3435	3436	3437	3438	3439
15	3440	3441	3442	3444	3445	3446	3447	3448	3449
16	3450	3451	3452	3454	3455	3456	3457	3458	3459
17	3460	3461	3462	3464	3465	3466	3467	3468	3469
18	3470	3471	3472	3474	3475	3476	3477	3478	3479
19	3480	3481	3482	3484	3485	3486	3487	3488	3489
20	3490	3491	3492	3494	3495	3496	3497	3498	3499
21	3500	3501	3502	3504	3505	3506	3507	3508	3509
22	3510	3511	3512	3514	3515	3516	3517	3518	3519
23	3520	3521	3522	3524	3525	3526	3527	3528	3529
24	3530	3531	3532	3534	3535	3536	3537	3538	3539
25	3540	3541	3542	3544	3545	3546	3547	3548	3549
26	3550	3551	3552	3554	3555	3556	3557	3558	3559
27	3560	3561	3562	3564	3565	3566	3567	3568	3569
28	3570	3571	3572	3574	3575	3576	3577	3578	3579
29	3580	3581	3582	3584	3585	3586	3587	3588	3589
30	3590	3591	3592	3594	3595	3596	3597	3598	3599
31	3600	3601	3602	3604	3605	3606	3607	3608	3609
32	3610	3611	3612	3614	3615	3616	3617	3618	3619
33	3620	3621	3622	3624	3625	3626	3627	3628	3629
34	3630	3631	3632	3634	3635	3636	3637	3638	3639
35	3640	3641	3642	3644	3645	3646	3647	3648	3649
36	3650	3651	3652	3654	3655	3656	3657	3658	3659
37	3660	3661	3662	3664	3665	3666	3667	3668	3669
38	3670	3671	3672	3674	3675	3676	3677	3678	3679
39	3680	3681	3682	3684	3685	3686	3687	3688	3689
40	3690	3691	3692	3694	3695	3696	3697	3698	3699
41	3700	3701	3702	3704	3705	3706	3707	3708	3709
42	3710	3711	3712	3714	3715	3716	3717	3718	3719
43	3720	3721	3722	3724	3725	3726	3727	3728	3729
44	3730	3731	3732	3734	3735	3736	3737	3738	3739
45	3740	3741	3742	3744	3745	3746	3747	3748	3749
46	3750	3751	3752	3754	3755	3756	3757	3758	3759
47	3760	3761	3762	3764	3765	3766	3767	3768	3769
48	3770	3771	3772	3774	3775	3776	3777	3778	3779
49	3780	3781	3782	3784	3785	3786	3787	3788	3789
50	3790	3791	3792	3794	3795	3796	3797	3798	3799
51	3800	3801	3802	3804	3805	3806	3807	3808	3809
52	3810	3811	3812	3814	3815	3816	3817	3818	3819
53	3820	3821	3822	3824	3825	3826	3827	3828	3829
54	3830	3831	3832	3834	3835	3836	3837	3838	3839
55	3840	3841	3842	3844	3845	3846	3847	3848	3849
56	3850	3851	3852	3854	3855	3856	3857	3858	3859
57	3860	3861	3862	3864	3865	3866	3867	3868	3869
58	3870	3871	3872	3874	3875	3876	3877	3878	3879
59	3880	3881	3882	3884	3885	3886	3887	3888	3889
60	3890	3891	3892	3894	3895	3896	3897	3898	3899
61	3900	3901	3902	3904	3905	3906	3907	3908	3909
62	3910	3911	3912	3914	3915	3916	3917	3918	3919
63	3920	3921	3922	3924	3925	3926	3927	3928	3929
64	3930	3931	3932	3934	3935	3936	3937	3938	3939
65	3940	3941	3942	3944	3945	3946	3947	3948	3949
66	3950	3951	3952	3954	3955	3956	3957	3958	3959
67	3960	3961	3962	3964	3965	3966	3967	3968	3969
68	3970	3971	3972	3974	3975	3976	3977	3978	3979
69	3980	3981	3982	3984	3985	3986	3987	3988	3989
70	3990	3991	3992	3994	3995	3996	3997	3998	3999
71	4000	4001	4002	4004	4005	4006	4007	4008	4009
72	4010	4011	4012	4014	4015	4016	4017	4018	4019
73	4020	4021	4022	4024	4025	4026	4027	4028	4029
74	4030	4031	4032	4034	4035	4036	4037	4038	4039
75	4040	4041	4042	4044	4045	4046	4047	4048	4049
76	4050	4051	4052	4054	4055	4056	4057	4058	4059
77	4060	4061	4062	4064	4065	4066	4067	4068	4069
78	4070	4071	4072	4074	4075	4076	4077	4078	4079
79	4080	4081	4082	4084	4085	4086	4087	4088	4089
80	4090	4091	4092	4094	4095	4096	4097	4098	4099
81	4100	4101	4102	4104	4105	4106	4107	4108	4109
82	4110	4111	4112	4114	4115	4116	4117	4118	4119
83	4120	4121	4122	4124	4125	4126	4127	4128	4129
84	4130	4131	4132	4134	4135	4136	4137	4138	4139
85	4140	4141	4142	4144	4145	4146	4147	4148	4149
86	4150	4151	4152	4154	4155	4156	4157	4158	4159
87	4160	4161	4162	4164	4165	4166	4167	4168	4169
88	4170	4171	4172	4174	4175	4176	4177	4178	4179
89	4180	4181	4182	4184	4185	4186	4187	4188	4189
90	4190	4191	4192	4194	4195	4196	4197	4198	4199
91	4200	4201	4202	4204	4205	4206	4207	4208	4209
92	4210	4211	4212	4214	4215	4216	4217	4218	4219
93	4220	4221	4222	4224	4225	4226	4227	4228	4229
94	4230	4231	4232	4234	4235	4236	4237	4238	4239
95	4240	4241	4242	4244	4245	4246	4247	4248	4249
96	4250	4251	4252	4254	4255	4256	4257	4258	4259
97	4260	4261	4262	4264	4265	4266	4267	4268	4269
98	4270	4271	4272	4274	4275	4276	4277	4278	4279
99	4280	4281	4282	4284	4285	4286	4287	4288	4289
100	4290	4291	4292	4294	4295	4296	4297	4298	4299

Appendix 4 Connection examples with servo amplifiers manufactured by MITSUBISHI Electric Corporation

Appendix 4.1 Connection example of A1SD75/AD75 and MR-H□A (Differential driver (Open collector)) *6

Configure a sequence to turn OFF the MC at alarms and emergency stops.

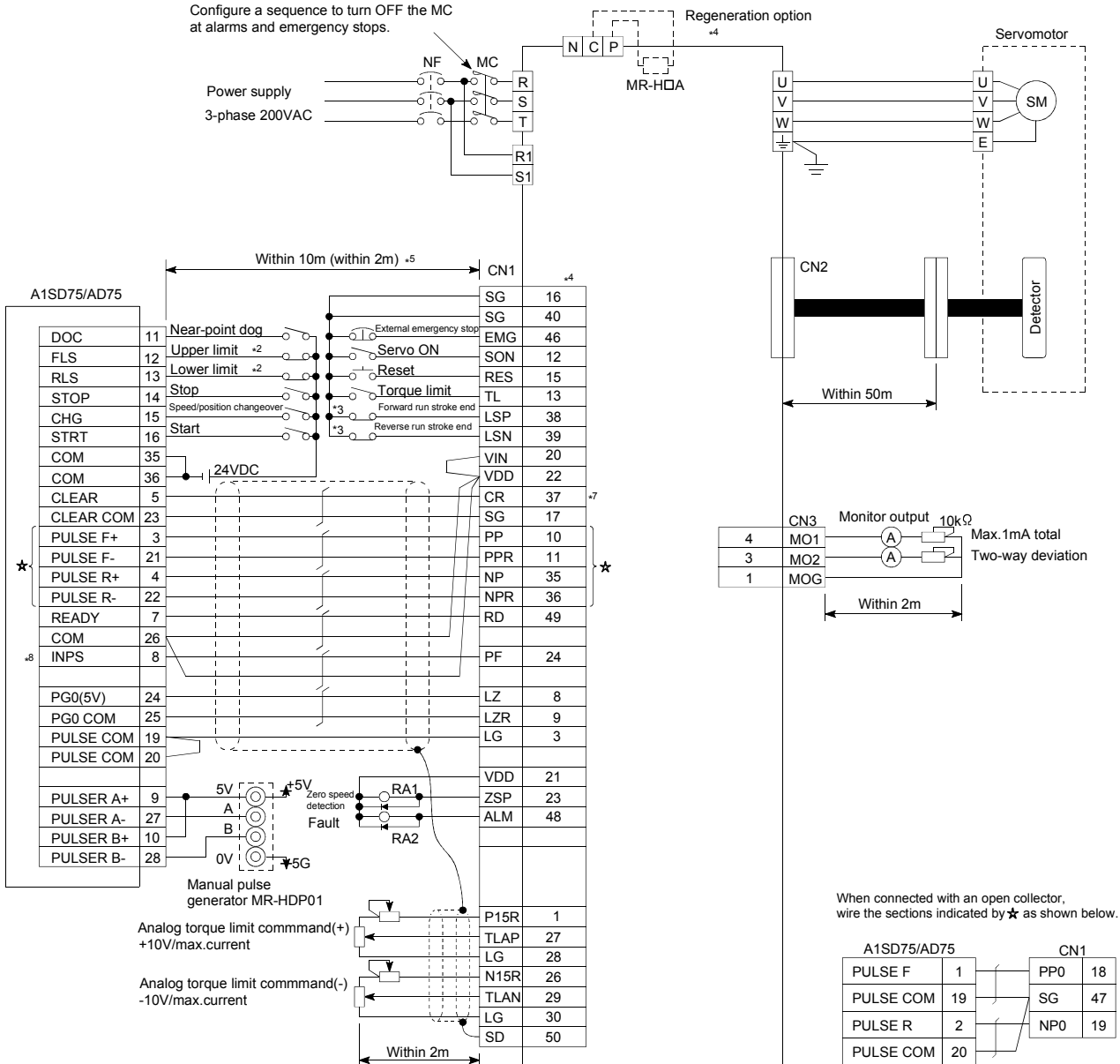

- *1 Assignment of the pin numbers of the connector of the A1SD75/AD75 is the same for axes 1 to 3.
- *2 The upper limit (FLS) and lower limit (RLS) of the A1SD75/AD75 are used for the zero point return retry function. Set these inside the limit switches for the servo.
- *3 Limit switch for servo (stopping).
- *4 For details of connection, refer to the specification manual of the servo amplifier MR-H.
- *5 The distance between the controller and amplifier is indicated. The distance must be within 2m with the open collector.
- *6 Use "Logic selection for pulse output to the drive unit" specified in detailed parameter 1 to match the logic (positive or negative logic) between the A1SD75/AD75 and the servo amplifier. The initial setting of A1SD75/AD75 is a positive logic.
- *7 Use the output module to issue a clear signal to the MR-H□A in a simple absolute position detection system. (Do not use the deviation counter clear output of the AD75.)
- *8 There is no need to wire the in-position signal. (It is output as "[Md.39] External input/output signal" but it is not used for internal processes of the AD75.)

REMARK

The AD75C20SH cable (for differential driver) can be used for the connection between the A1SD75/AD75 and MR-H□A. (Refer to section 2.2 "List of configuration devices.")

Appendix 4.2 Connection example of A1SD75/AD75 and MR-J2/J2S-□A (Differential driver (Open collector)) *5

Configure a sequence to turn OFF the MC at alarms and emergency stops.

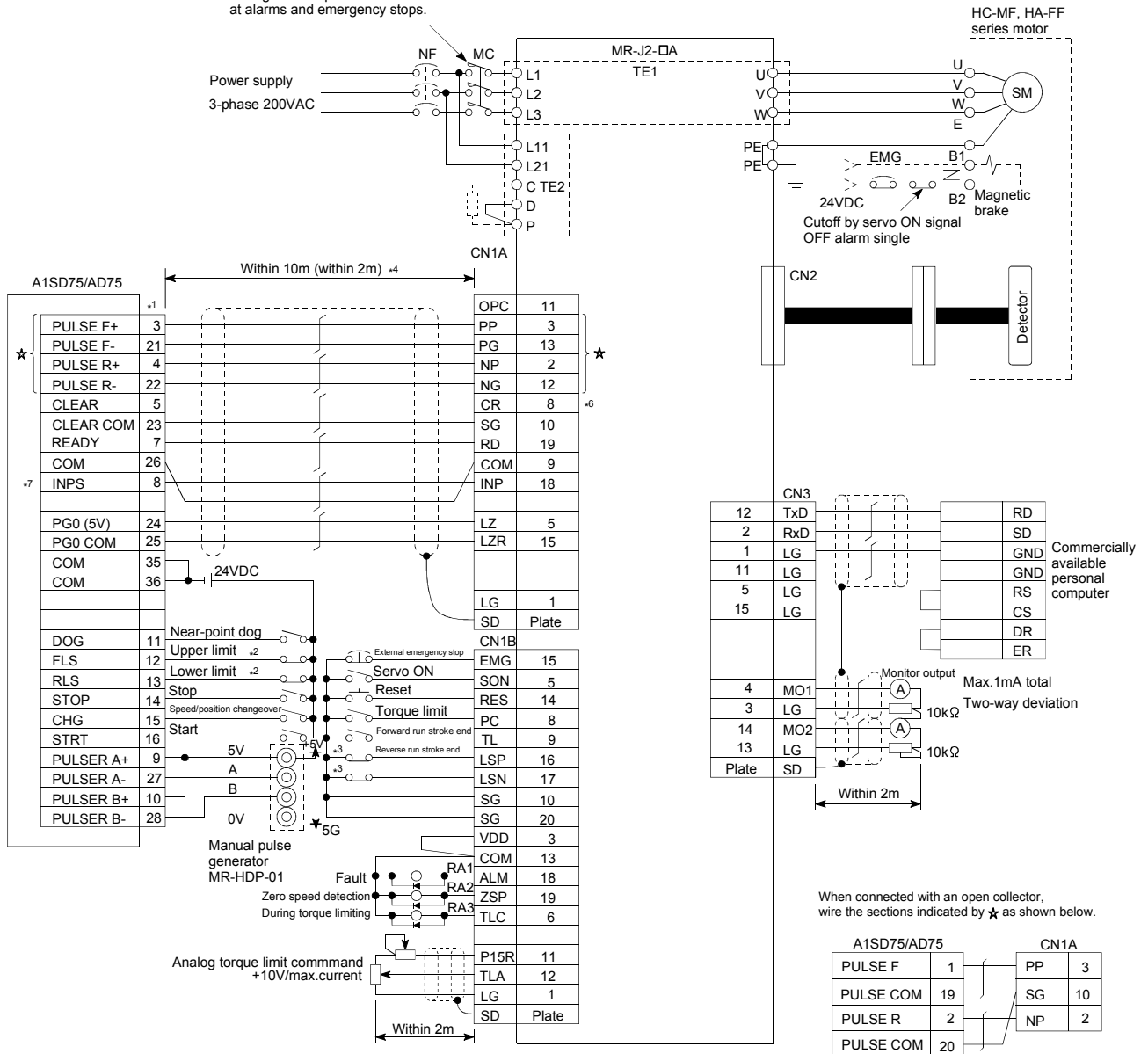

- *1 Assignment of the pin numbers of the connector of the A1SD75/AD75 is the same for axes 1 to 3.
- *2 The upper limit (FLS) and lower limit (RLS) of the A1SD75/AD75 are used for the zero point return retry function. Set these inside the limit switches for the servo.
- *3 Limit switch for servo (stopping).
- *4 The distance between the controller and amplifier is indicated. The distance must be within 2m with the open collector.
- *5 Use "Logic selection for pulse output to the drive unit" specified in detailed parameter 1 to match the logic (positive or negative logic) between the A1SD75/AD75 and the servo amplifier. The initial setting of A1SD75/AD75 is a positive logic.
- *6 Use the output module to issue a clear signal to the MR-J2/J2S-□A in a simple absolute position detection system. (Do not use the deviation counter clear output of the AD75.)
- *7 There is no need to wire the in-position signal. (It is output as "Md.39 External input/output signal" but it is not used for internal processes of the AD75.)

REMARK

The AD75C20SJ2 cable (for differential driver) can be used for the connection between the A1SD75/AD75 and MR-J2/J2S-□A. (Refer to section 2.2 "List of configuration devices.")

Appendix 4.3 Connection example of A1SD75/AD75 and MR-C□A
(Differential driver (Open collector)) *5

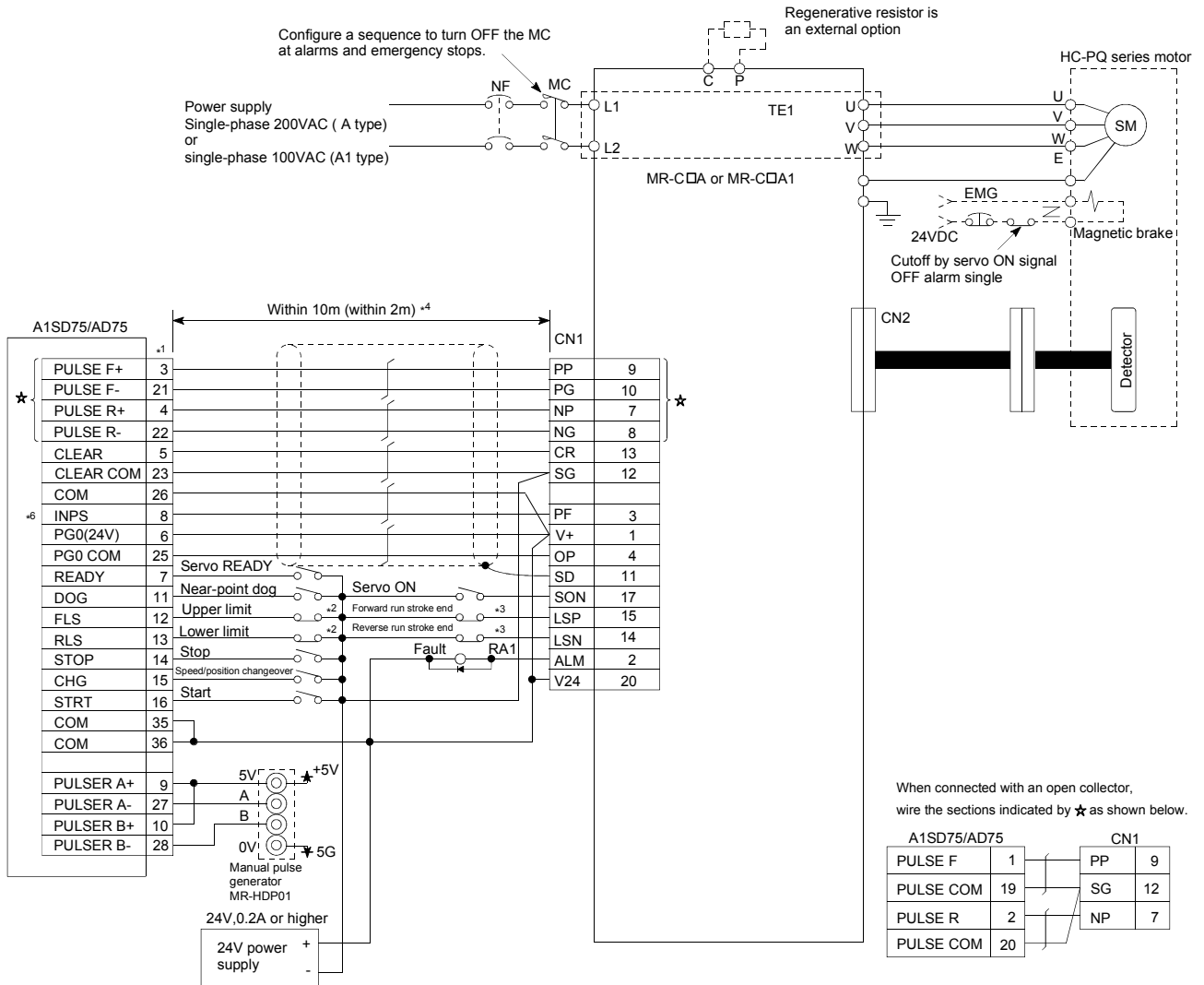

- *1 Assignment of the pin numbers of the connector of the A1SD75/AD75 is the same for axes 1 to 3.
- *2 The upper limit (FLS) and lower limit (RLS) of the A1SD75/AD75 are used for the zero point return retry function. Set these inside the limit switches for the servo.
- *3 Limit switch for servo (stopping).
- *4 The distance between the controller and amplifier is indicated. The distance must be within 2m with the open collector.
- *5 Use "Logic selection for pulse output to the drive unit" specified in detailed parameter 1 to match the logic (positive or negative logic) between the A1SD75/AD75 and the servo amplifier. The initial setting of A1SD75/AD75 is a positive logic.
- *6 There is no need to wire the in-position signal. (It is output as "Md.39 External input/output signal" but it is not used for internal processes of the AD75.)

REMARK

The AD75C20SC cable (for differential driver) can be used for the connection between the A1SD75/AD75 and MR-C□A. (Refer to section 2.2 "List of configuration devices.")

Appendix 5 Connection examples with stepping motors manufactured by ORIENTALMOTOR Co., Ltd.

Appendix 5.1 Connection example of A1SD75/AD75 and VEXTA UPD (Open collector) *4

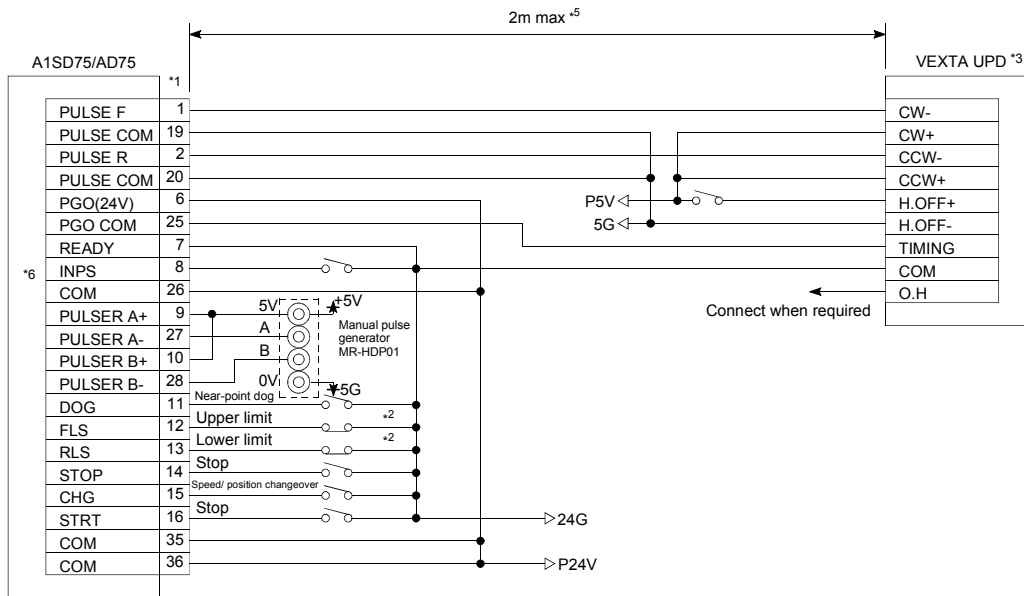

- *1 Assignment of the pin numbers of the connector of the A1SD75/AD75 is the same for axes 1 to 3.
- *2 The upper limit (FLS) and lower limit (RLS) of the A1SD75/AD75 are used for the zero point return retry function.
- *3 For cable connections on the stepping motor drive side other than those specified above and shields of each signal cable, refer to the manual prepared for the stepping motor drive.
- *4 Use "Logic selection for pulse output to the drive unit" specified in detailed parameter 1 to match the logic (positive or negative logic) between the A1SD75/AD75 and the servo amplifier. The initial setting of A1SD75/AD75 is a positive logic.
- *5 Indicates the distance between the A1SD75/AD75 and VEXTA UPD.
- *6 There is no need to wire the in-position signal.
(It is output as "[Md.39] External input/output signal" but it is not used for internal processes of the AD75.)

Appendix 6 Connection examples with servo amplifiers manufactured by Matsushita Electric Industrial Co., Ltd.

Appendix 6.1 Connection example of A1SD75/AD75 and MINAS-A series (Differential driver) *4

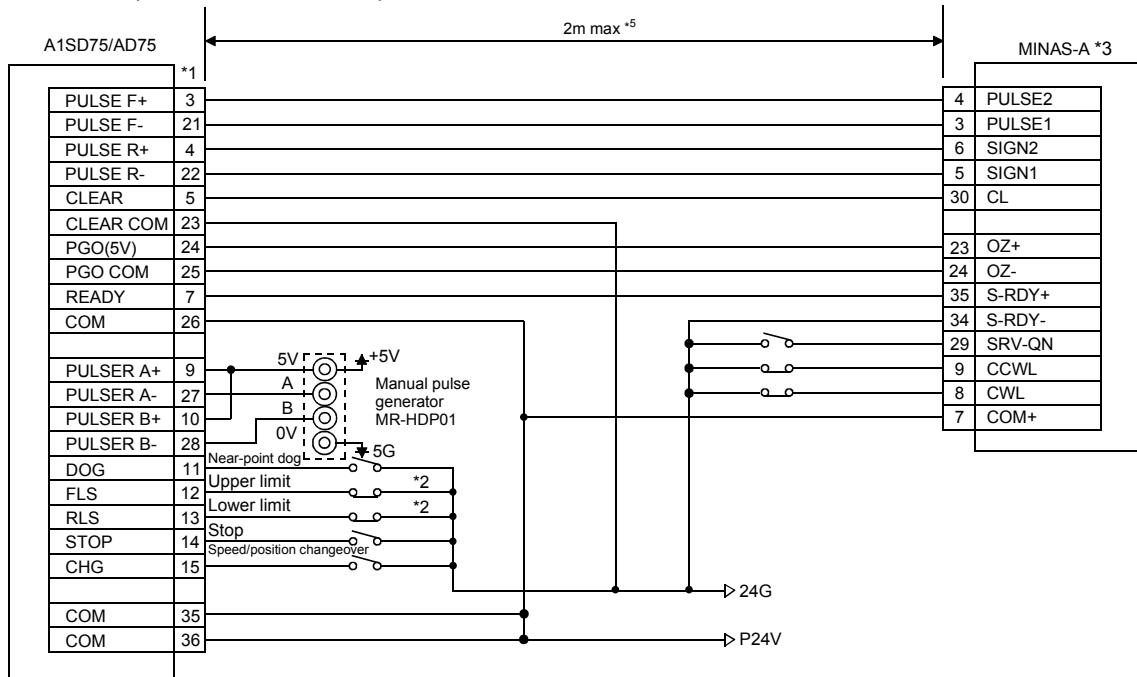

- *1 Assignment of the pin numbers of the connector of the A1SD75/AD75 is the same for axes 1 to 3.
- *2 The upper limit (FLS) and lower limit (RLS) of the A1SD75/AD75 are used for the zero point return retry function. Set these inside the limit switches for the servo.
- *3 For the connections on the servo amplifier side other than those specified above and the shields of each signal cable, refer to the manual prepared for the servo amplifier.
- *4 Use "Logic selection for pulse output to the drive unit" specified in detailed parameter 1 to match the logic (positive or negative logic) between the A1SD75/AD75 and the servo amplifier. The initial setting of A1SD75/AD75 is a positive logic.
- *5 Indicates the distance between the A1SD75/AD75 and MINAS-A.

Appendix 7 Connection examples with servo amplifiers manufactured by SANYO DENKI Co., Ltd.

Appendix 7.1 Connection example of A1SD75/AD75 and PYO series (Differential driver) *4

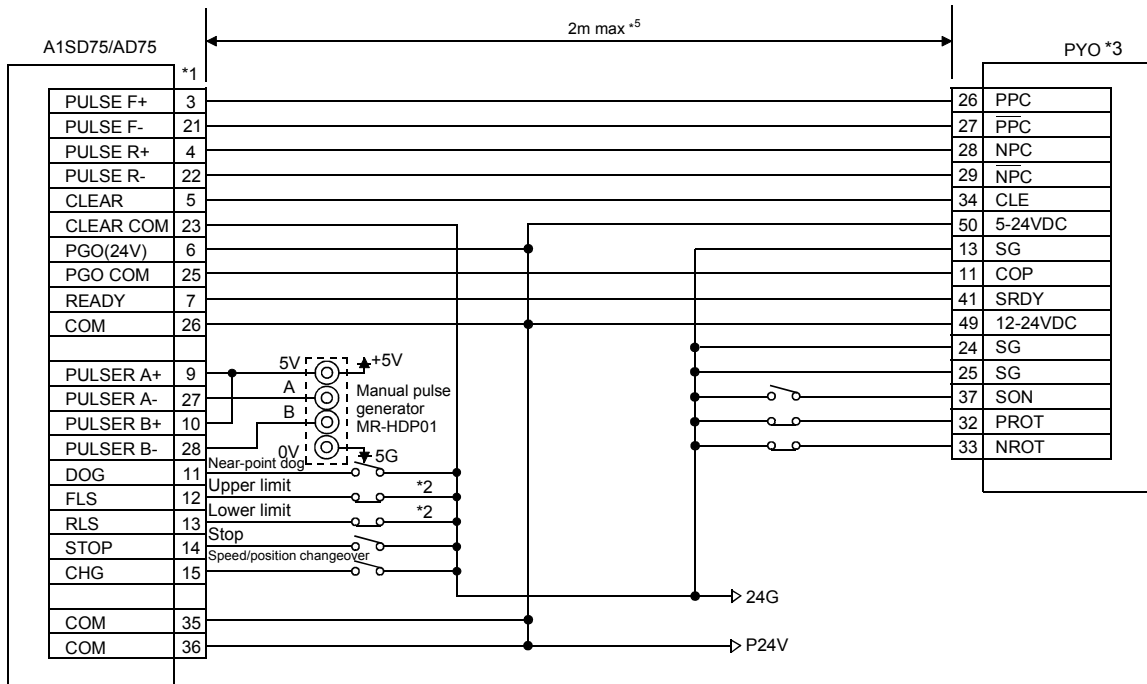

- *1 Assignment of the pin numbers of the connector of the A1SD75/AD75 is the same for axes 1 to 3.
- *2 The upper limit (FLS) and lower limit (RLS) of the A1SD75/AD75 are used for the zero point return retry function. Set these inside the limit switches for the servo.
- *3 For the connections on the servo amplifier side other than those specified above and the shields of each signal cable, refer to the manual prepared for the servo amplifier.
- *4 Use "Logic selection for pulse output to the drive unit" specified in detailed parameter 1 to match the logic (positive or negative logic) between the A1SD75/AD75 and the servo amplifier. The initial setting of A1SD75/AD75 is a positive logic.
- *5 Indicates the distance between the A1SD75/AD75 and PYO.

Appendix 8 Connection examples with servo amplifiers manufactured by YASKAWA Electric Corporation

Appendix 8.1 Connection example of A1SD75/AD75 and Σ -II series (Differential driver) *4

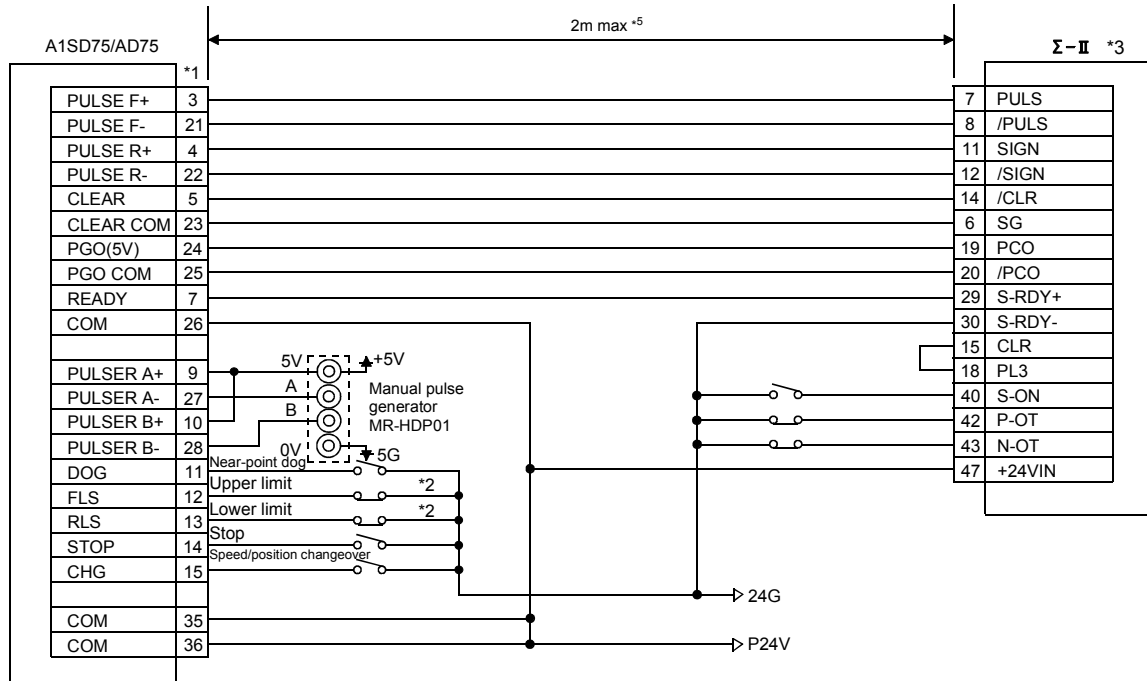

- *1 Assignment of the pin numbers of the connector of the A1SD75/AD75 is the same for axes 1 to 3.
- *2 The upper limit (FLS) and lower limit (RLS) of the A1SD75/AD75 are used for the zero point return retry function. Set these inside the limit switches for the servo.
- *3 For the connections on the servo amplifier side other than those specified above and the shields of each signal cable, refer to the manual prepared for the servo amplifier.
- *4 Use "Logic selection for pulse output to the drive unit" specified in detailed parameter 1 to match the logic (positive or negative logic) between the A1SD75/AD75 and the servo amplifier. The initial setting of A1SD75/AD75 is a positive logic.
- *5 Indicates the distance between the A1SD75/AD75 and Σ -II.

Appendix 9 Comparisons with conventional positioning modules

Appendix 9.1 Comparisons with AD71 (S1), AD71S2 (A1SD71S2) models

The following shows comparisons with the conventional positioning modules AD71 (S1) and AD71S2 (A1SD71S2), centered on the AD75 specifications.

Item		Model	A1SD75P1-S3 AD75P1-S3	A1SD75P2-S3 AD75P2-S3	A1SD75P3-S3 AD75P3-S3	AD71 (S1)	A1SD71S2 AD71S2
No. of control axes			1	2	3	2	
No. of positioning data items			600/axis * ¹			400/axis	
Interpolation functions	2-axis linear interpolation		×	○		○	
	2-axis circular interpolation		×	○		×	
Positioning methods	Position control			○		○	○
	Speed control			○		×	○
	Speed/position changeover control			○		×	○
Zero point return function			○ (6 types)			○	
JOG operation				○		○	
Manual pulse generator function				○		○	×
Acceleration/deceleration processing	Automatic trapezoidal acceleration/deceleration			○		○	
	S-curve acceleration/deceleration			○		×	
Acceleration/deceleration time			Acceleration time and deceleration time setting possible (4 patterns each)			Acceleration/deceleration time same	
Compensation			Electronic gears, backlash compensation			Backlash compensation	
Error display			17-segment display			Error LED	
History data storage (Start, error, warning)			Provided (4 types, 16 items/axis)			None	
Data storage destination			Flash ROM (battery-less backup)			Buffer memory (battery backup)	
No. of occupied input/output points			32			32	32 (48) * ²
No. of module occupied slots			1			1	1 (2) * ³
Peripheral devices (data setting, etc.)	AD71TU			×		○	
	AD75TU			○		×	
	A6GPP, A6PHP			×		○	
	DOS/V personal computer			○		○	

○ : Possible, × : Not possible

REMARK

- *¹ Up to 100 data items/axis of the positioning data No. 1 to 100 can be set using the AD75 buffer memory. Buffer memory positioning data is not backed up.
 *² The A1SD71S2 has 48 input/output points.
 *³ The A1SD71S2 occupies 2 slots.

Appendix 9.2 Comparisons with A1SD75P1/A1SD75P2/A1SD75P3, and AD75P1/ AD75P2/ AD75P3 models

The following shows comparisons with the A1SD75P1-S3/A1SD75P2-S3/A1SD75P3-S3, AD75P1-S3/AD75P2-S3/AD75P3-S3, and A1SD75P1/A1SD75P2/A1SD75P3, AD75P1/ AD75P2/AD75P3 models.

	A1SD75P□-S3 AD75P□-S3	A1SD75P□, AD75P□ software version		Reference
		"R" and subsequent versions	"Q" and prior versions	
Pulse output logic selection	Possible (positive logic/negative logic changeover)	Not possible (positive logic)		Pr.24
Positioning data block transmission	Possible	Not possible		Section 7.2
Acceleration/deceleration time setting	1 to 65535ms/ 1 to 8388608ms changeover possible	1 to 65535ms		Pr.25
JUMP command	Provided	Not provided		Section 9.2.11
Continuous operation interrupt function	Provided	Not provided		Section 6.5.4
Bias speed at start setting	Possible	Possible	Not possible	Pr.10
Stepping motor mode selection	Possible	Possible	Not possible	Pr.11
Operation speed selection at zero point shift	Possible	Possible	Not possible	Pr.57
Dwell time setting at zero point retry function	Possible	Possible	Not possible	Pr.58
Acceleration/deceleration time change function at speed change	Possible	Possible	Not possible	Section 12.5.3
Current value clear function during speed/position changeover control	Possible	Possible	Not possible	Pr.22

Appendix 9.3 Comparisons with old versions of A1SD75P1-S3/A1SD75P2-S3/A1SD75P3-S3, and AD75P1-S3/AD75P2-S3/AD75P3-S3 models

The following shows performance comparisons and function comparisons with old versions of A1SD75P1-S3/A1SD75P2-S3/A1SD75P3-S3, and AD75P1-S3/AD75P2-S3/AD75P3-S3 models. A list of buffer memory addresses for additional functions is also shown.

(1) Performance comparisons

Item	Connection method to servo amplifier	A1SD75P3-S3 and AD75P3-S3 hardware version		Reference
		"F" and subsequent versions	"E" and prior versions	
Internal current consumption (5VDC)	Differential driver	0.78A	0.7A	Section 3.2
	Open collector	0.7A	0.7A	

(2) Function comparisons

Item		A1SD75P□-S3 and AD75P□-S3 software version		Reference
		"F" and subsequent versions	"E" and prior versions	
Near pass mode functions	Positioning address pass mode	Provided	Provided	Section 12.3.3
	Near pass mode	Provided	Not provided	
Parameter initialization function		Possible	Not possible	Section 13.2

(3) Additional buffer memory

Buffer memory address			Name	Function used
Axis 1	Axis 2	Axis 3		
66	216	366	Near pass mode selection for path control	Near pass mode function
1136			Parameter initialization request	Parameter initialization function

Appendix 10 MELSEC Explanation of positioning terms

1-2 PHASE EXCITATION SYSTEM

This is one system for exciting each stepping motor coil in a determined order. In this system, one phase and two phases are alternately excited.

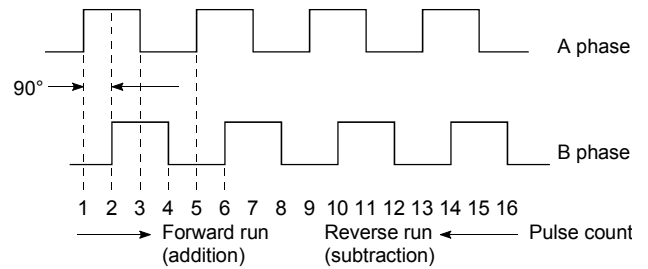
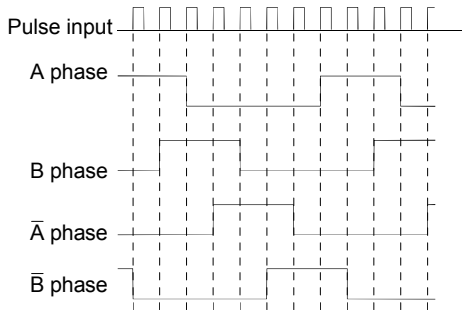

2-PHASE EXCITATION SYSTEM

This is one system for exciting each stepping motor coil in a determined order. In this system, a current constantly flows to 2 phases to carry out step feed.

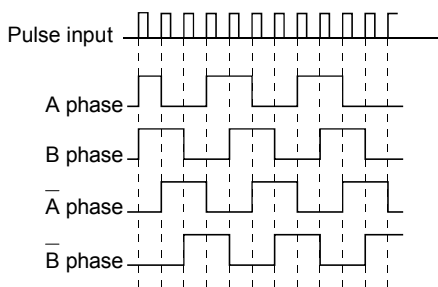

2-SPEED TRAPEZOIDAL CONTROL

In this positioning control method, the positioning pattern, positioning addresses (P1, P2), and positioning speeds (V1, V2) are set in the sequence program. Positioning is carried out to positioning address P1 by issuing the 1st positioning start command. When P1 is reached, the positioning then automatically changes to positioning at the V2 speed.

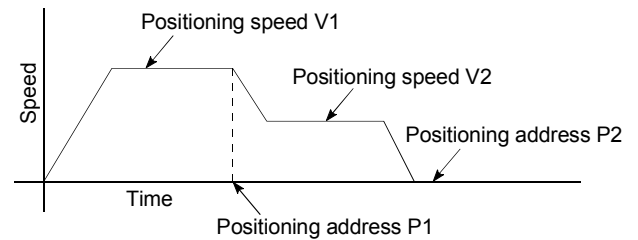

2-PHASE PULSE

An A phase and B phase double pulse. There is a phase difference between the two phases, so that difference can be automatically added and subtracted in the pulse count. The standard phase difference is a 90° electrical angle.

If the B phase were to lag behind the A phase in a forward run (B phase turns ON after the A phase), the A phase would lag behind the B phase in a reverse run (A phase turns ON after the B phase). In this way the forward and reverse run (addition and subtraction) can be automatically carried out.

ABSOLUTE ENCODER

This is a detector that enables the angle data within 1 motor rotation to be output to an external destination. Absolute encoders are generally able to output 360° in 8 to 12 bits. Incremental encoders have a disadvantage in that the axis position is lost when a power failure occurs. However, with absolute encoders, the axis position is not lost even when a power failure occurs. Various codes such as a binary code and BCD code can be output. Absolute encoders are more expensive, more accurate, and larger than incremental encoders. Refer to "ENCODER".

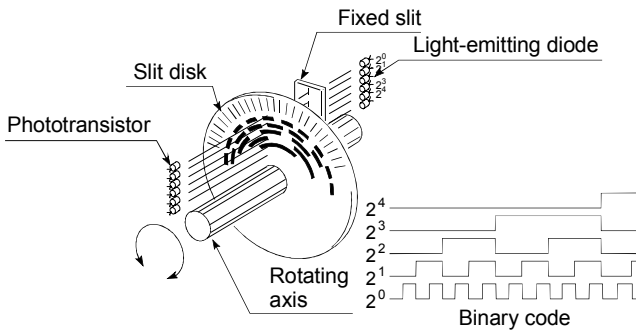

ABSOLUTE POSITION DETECTION SYSTEM

When positioning is carried out using this system, a zero point return can be carried out once when the device is started to allow the machine position to be stored in the memory and the current position to be held even when the power is turned OFF. These will be compensated if mechanical deviation occurs, so a zero point return is not required after the power is turned ON again. A motor with an absolute position detector and servo amplifier and positioning module compatible with an absolute position detection system are required to configure this system.

ABSOLUTE SYSTEM

This is one system for expressing a positioning address. Absolute address system. This system uses 0 as a reference, and expresses the address as the distance from 0. The direction is automatically determined, even when it is not designated. The other address system is the increment system.

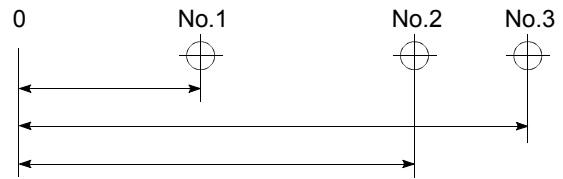

ACCELERATION TIME

The parameter acceleration time refers to the time from a stopped state to the time the speed limit value is reached, so it becomes proportionally shorter as the setting speed decreases. The acceleration time is determined by factors such as machine inertia, motor torque, and load resistance torque.

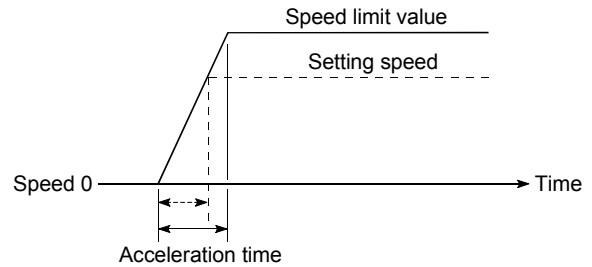

ADDRESS

- 1) This is a numerical value to express the positioning position, designated in mm, inch, angle, or No. of pulse units.
- 2) The memory address. Many addresses are stored in the memory. An address is read or written after it is designated.

AFTER mode

This is the mode that outputs the M code after positioning is complete (after stopping). Clamping can be commanded, drilling dimensions can be selected, etc., with this mode.

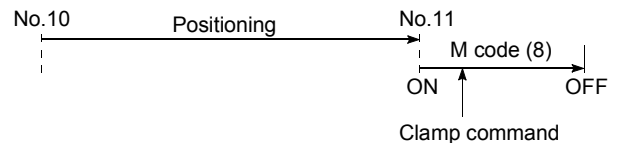

AUTO TUNING (Automatic Tuning)

Properties such as responsiveness and stability of machines driven with a servomotor are affected by changes in the inertia moment and rigidity due to changes in the machine load, etc.

This function automatically adjusts the speed loop gain and position loop gain to match the machine state, so the machine's performance can be maintained at its optimum state. A real time automatic tuning function should be used for machines having large load fluctuations.

AUTOMATIC TRAPEZOIDAL ACCELERATION/DECELERATION

An operation in which a graph of the time and speed takes a trapezoidal shape.

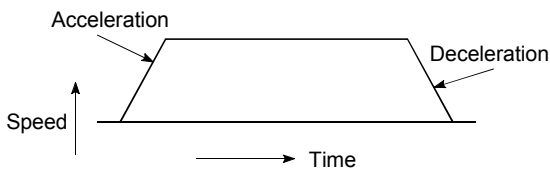

BACKLASH COMPENSATION

When a forward run operation changes to a reverse run operation, there is sometimes play (backlash) in the mesh of the toothed gears. This also occurs when using a worm gear. Because of this backlash, a left feed of 1m carried out after a right feed of 1m will not be sufficient to return the machine to its original position. The machine cannot be positioned to its original position without an extra feed equivalent to the backlash amount. This function compensates for that backlash amount.

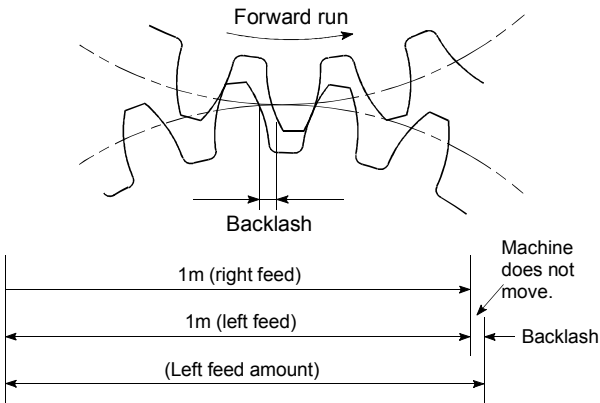

BACKUP FUNCTION

Backup functions consist of the following.

- 1) Functions for storing the sequence program and device statuses stored in the RAM memory of the PLC CPU, so that they are not lost during power failures, etc.
- 2) Functions for storing the current value in absolute position compatible systems so that it is not lost during power failures, etc.
- 3) Functions for reading the PLC CPU data (PLC programs, parameters, positioning data, etc.) by a peripheral device when the old CPU is replaced, and then write it to the new PLC CPU after the replacement is completed.

BALL SCREW

This is a type of screw, with balls lined up in the threads like ball bearings. This reduces backlash, and enables rotation with little force.

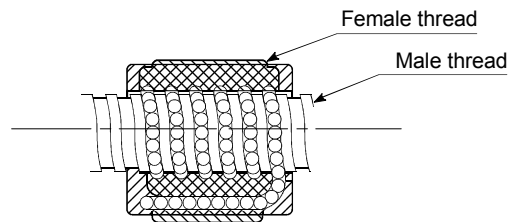

BIAS SPEED AT START

A large amount of torque is required when the machine starts moving, but the torque may be unstable at speed 0 with stepping motors. Therefore, movement can be smoothly carried out by starting the movement at a given speed from the beginning. The bias speed at start is the speed set at that start.

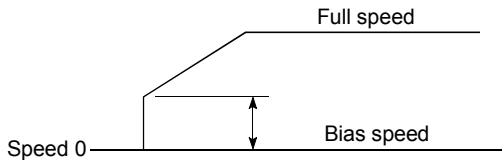

BIPOLAR DRIVE CONSTANT-CURRENT SYSTEM

This is one system for driving a stepping motor. In this method, the orientation of the excitation current flowing to the stator coil is reversed, and the excitation current direction is in both the positive and negative direction. This enables the motor coil to be used effectively, and a large output torque can be obtained at low speeds.

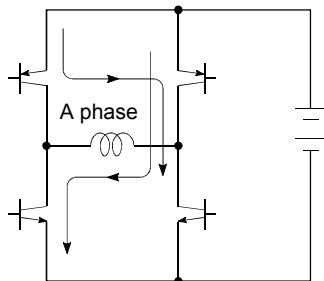

Bipolar drive basic circuit (bridge method)

BUSY

The device is doing some other work. It is in a positioning operation or in dwell time.

CCW (Counterclockwise)

Rotation in the counterclockwise direction. In the motor, this is determined looking from the shaft end side. Also refer to "CW".

CHANGE signal

The CHANGE signal is an external signal used to change the speed/position control from the speed control being executed to position control.

CIRCULAR INTERPOLATION

Automatic operation in which the machine path makes a circle when positioning is carried out by simultaneously operating both the longitudinal feed and latitudinal feed motors. The normal unit is 90°. Round shapes can be created with this type of interpolation, and obstacles in the machine path can also be avoided. Refer to the terms "INTERPOLATION OPERATION" and "LINEAR INTERPOLATION"

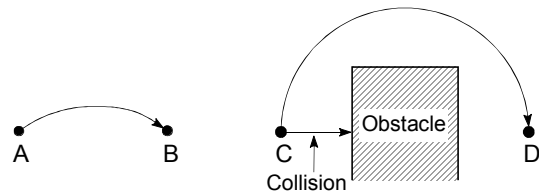

COMMAND PULSE

Refer to the term "FEEDBACK PULSE".

COMPOSITE SPEED

The movement speed for the target control during interpolation operations.

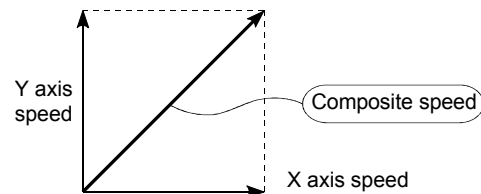

CONTINUOUS POSITIONING CONTROL

Refer to the term "OPERATION PATTERN".

CONTROL UNIT

This is one type of positioning reference data. The unit to be used is designated as mm, inch, degree, or pulse.

CP CONTROL (Continuous Path Control)

Continuous path is a control method in which a path is followed without interrupting such as in uniform speed control.

CREEP SPEED

A speed at which the machine moves very slowly.
 It is difficult for the machine to stop accurately when running at high speed, so the movement must first be changed to the creep speed before stopping.
 Refer to the term "NEAR-POINT DOG".

CURRENT FEED VALUE

The zero point address at the completion of the machine zero point return is stored.
 The position currently being executed is stored.
 This value changes when the current value is changed.

CURRENT LOOP MODE

This is one servo control mode used in positioning. It is a mode for controlling the torque using the current. Also called the torque loop mode. Refer to "POSITIONING LOOP MODE".

CURRENT VALUE

This is the current address (position) when stopped or during positioning.

CURRENT VALUE CHANGE

The AD75 has no way of knowing the current value when the machine is assembled and the AD75 is connected, so this function is used to teach it a temporary approximate value as the current value. This function can also be used to write a temporary current value when the current value has been lost due to accidents, etc. If a machine zero point return is carried out after that, the AD75 will recognize the zero point.
 In fixed-dimension feed, etc., rewriting the current value to 0 after the fixed-dimension feed will keep the accumulated value from being affected by the upper stroke limit. The current value can be changed during a positioning stop.

CW (Clockwise)

Rotation in the clockwise direction. Rotation in the clockwise direction looking from the motor shaft end side.

D/A CONVERTER (Digital-to-Analog converter)

A device having a function to convert the digital value expressing the No. of pulses to an analog value expressing the voltage (or current).

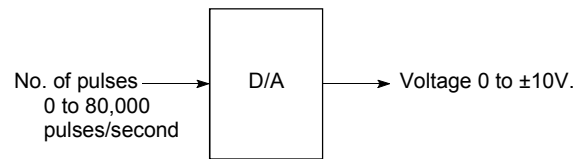

DATA NO.

To carry out positioning to 2 or more addresses, each position is assigned a sequence No. such as No. 1, No. 2, No. 3, etc. The positioning is then carried out following this sequence. The AD75 is capable of positioning up to No. 600.

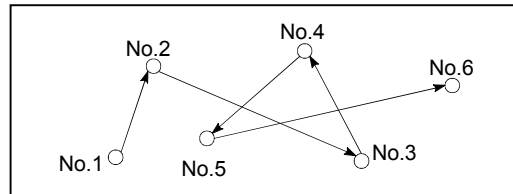

DECELERATION RATIO

A ratio used when the machine is decelerated using a toothed gear. This ratio is a numeral larger than 1.

$$\text{Deceleration ratio} = \frac{\text{Input gear speed}}{\text{Output gear speed}}$$

DECELERATION TIME

The parameter deceleration time is the same value as the acceleration time. Deceleration time refers to the time from the speed limit value to a stopped state, so it becomes proportionally shorter as the setting speed decreases.

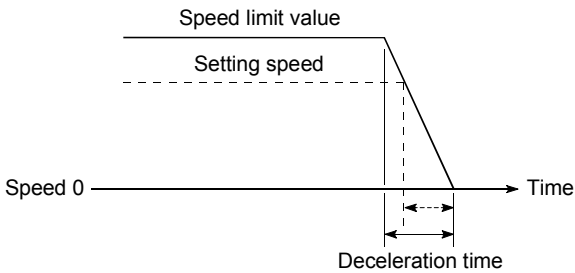

DEVIATION COUNTER

Deviation counters have the following two functions.

- 1) To count the command pulses issued from the AD75, and transmit the count value to the D/A converter.
- 2) To subtract the feedback pulses from the command pulses, and run the motor by the deviation value (droop pulse) of the command pulses and feedback pulses until the command pulses reaches 0.

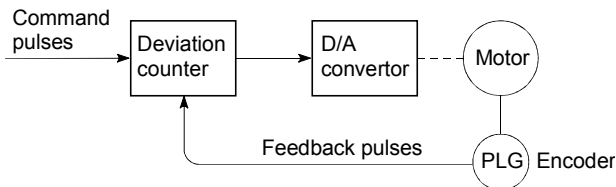

DIFFERENTIAL OUTPUT TYPE

This is one type of encoder feedback pulse output. When one signal is output with this method, a companion signal having the reverse polarity is simultaneously output. This method enables high-frequency transfer, and is resistant to noise, etc., so it is also used in high-speed signal transfer such as inputting and outputting of pulse trains. In general, the transmission side is called the driver, the reception side is called the receiver, and a dedicated IC is used.

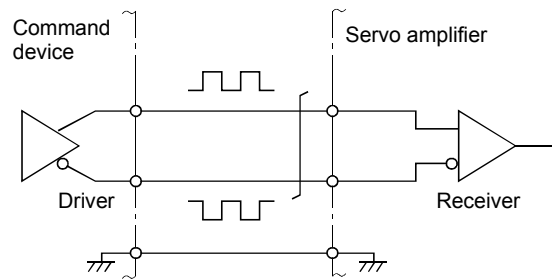

DIGITAL BUS CONNECTION

Commands are generally output from the positioning module to the servo amplifier as a pulse train. Recently, however, devices are being digitalized. Accompanying that, a connection method has appeared in which the bus lines of both the positioning module and the servo amplifier CPUs are connected. This has enabled the construction of higher-accuracy, higher-speed systems. The MELSEC AD774M, A171SCPU, A273UCPU etc., models employ this digital bus connection.

DOG SIGNAL

The near-point dog of the machine zero point return.

DRIVE UNIT

The commands output from the positioning module are low-voltage, low-current commands with insufficient energy to run the motor.

The drive unit increases the width of these commands so the motor can be run. It is an accessory on servomotors and stepping motors. Also called a servo amplifier.

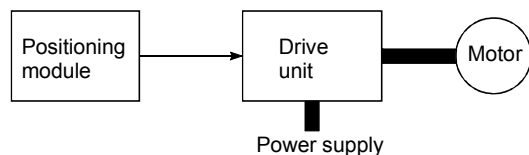

DRIVE UNIT READY

This signal is output when the drive unit for the motor is in a READY state. This signal remains OFF when the drive unit power is OFF, or during faults, etc.

DROOP PULSE

Because of inertia in the machine, it will lag behind and not be able to track if the positioning module speed commands are issued in their normal state. Thus, for a servomotor, a method is used in which the speed command pulses are delayed by accumulation in a deviation counter. These accumulated pulses are called the droop pulse. The deviation counter emits all pulses and returns to 0 when the machine stops.

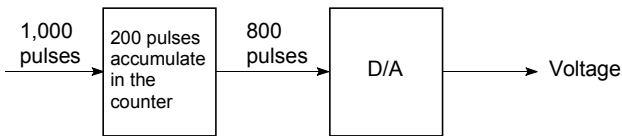

DWELL TIME

This is the time taken immediately after the positioning is completed to adjust for the droop pulses in the deviation counter. The positioning will not be accurate if this time is too short.

DYNAMIC BRAKE

When protection circuits operate due to power failures, emergency stops (EMG signal) etc., this function is used to short-circuit between servomotor terminals via a resistor, thermally consume the rotation energy, and cause a sudden stop without allowing coasting of the motor. Braking power is generated by electromagnetic brakes only when running motors with which a large brake torque can be obtained. Because electromagnetic brakes have no holding power, they are used in combination with mechanical brakes to prevent dropping of the vertical axis.

ELECTROMAGNETIC BRAKE

This function is supplied on motors with electromagnetic brakes. Electromagnetic brakes are used to prevent slipping during power failures and faults when driving a vertical axis, or as a protective function when the machine is stopped. These brakes are activated when not excited.

ELECTRONIC GEAR

This function electrically increases/decreases the command pulses No. from the AD75. Thus, the positioning speed and movement amount can be controlled by the electronic gear ratio magnification.

EMERGENCY STOP

Emergency stops cannot be carried out by the AD75, so a method of shutting OFF the servo side power supply from outside the PLC, etc., must be considered.

ENCODER

This device turns the input data into a binary code of 1 (ON) and 0 (OFF). A type of pulse generator.

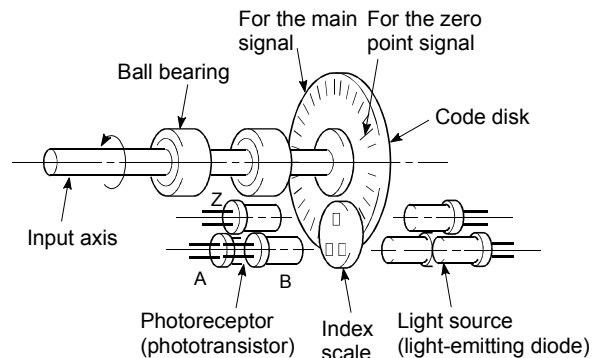

Rotary encoder

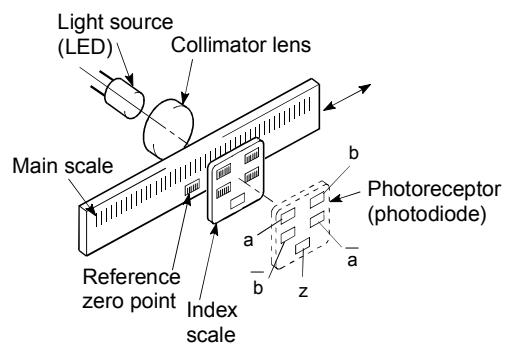

Linear encoder

ERROR CORRECTION

If a dimension error occurs in the machine, and that error is actually smaller or larger than 1m in spite of a 1m command being issued from the AD75, that error amount will be compensated. For example, when the error is actually smaller than 1m, the remaining distance to 1m is fed, and the correct 1m of positioning is carried out.

ERROR RESET

This resets error of axis. Note that if the cause of the error is not eliminated at that time, the error will occur again.

EXTERNAL REGENERATIVE BRAKE RESISTOR

This is also called the regenerative brake. When a machine is moved with a motor, power is normally supplied to the motor from an amplifier. However, the rotation energy in the motor and machine counterflows (regenerates) to the amplifier when the motor is decelerating or when driving a descending load. The external regenerative resistor consumes this regeneration energy with resistance, obtains the regenerative brake torque, and enables the full capacity of the regeneration system during stopping. It is used when carrying out highly repetitive acceleration/deceleration.

F

In the AD75, this is a status where there is a fault in the module itself.

FEED PULSE

This is a pulse issued from the positioning module to a servomotor or stepping motor. Also called a command pulse.

FEEDBACK PULSE

This is a method of using a returning pulse train to confirm whether the machine faithfully operated according to the commands issued in automatic control. If the machine did not faithfully operate according to the commands, a correction command is issued. For example, if a command is issued for 10,000 pulses, and a feedback pulse of 10,000 pulses is returned, then the balance becomes 0 and it can be judged that the command was faithfully followed. Refer to the term "DEVIATION COUNTER".

FIXED-DIMENSION FEED

This is the feeding of a set dimension for cutting sheet and bar workpieces into the designated dimensions. Increment system positioning is often used. The current value is not incremented, even when the feed operation is repeated.

FLASH MEMORY

This battery-less memory can be used to store parameters and positioning data for backup. Because it is battery-less, battery maintenance is not required.

FLS SIGNAL (Forward Limit Signal)

This is the input signal that notifies the user that the limit switch (b contact configuration, normally continuity) installed at the upper limit of the positioning control enabled range was activated. The positioning operation stops when the FLS signal turns OFF (non-continuity).

GAIN

The changing of the ratio between two values having a proportional relation. Seen on a graph, the changing of the incline of the characteristics.

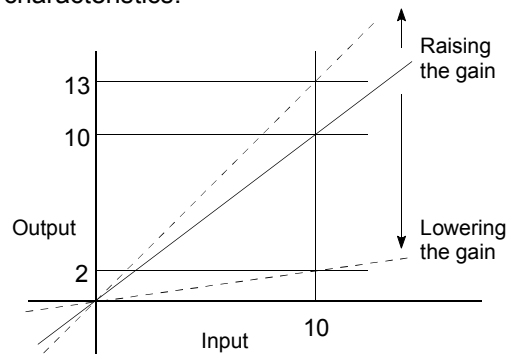

For example, when 10 is output for an input of 10, the output can be changed to 12, 5, etc., by changing the gain.

HIGH-SPEED MACHINE ZERO POINT RETURN

In this zero point return method the near-point dog is not detected. The positioning data address is replaced with the machine zero point address, and the positioning data is executed to carry out high-speed positioning to the zero point at a designated speed.
(This is not validated unless a machine zero point return has been carried out first.)

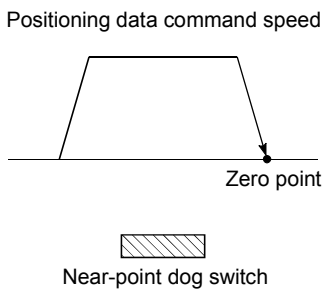

HIGH-SPEED ZERO POINT RETURN

The axis returns to the machine zero point at the zero point return speed without detecting the near-point dog.
(This is not validated unless a machine zero point return has been carried out first.)

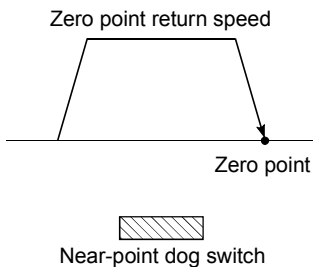

INCREMENT SYSTEM

The current value is 0 in this system. Positions are expressed by the designated direction and distance of travel. Also called the relative address system. This system is used in fixed-dimension feed, etc. Compare ABSOLUTE SYSTEM.

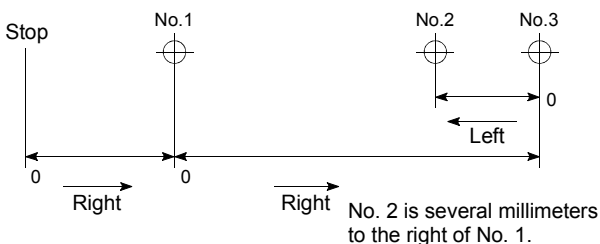

INCREMENTAL ENCODER

A device that simply outputs ON/OFF pulses by the rotation of the axis. 1-phase types output only A pulses, and do not indicate the axis rotation direction. 2-phase types output both A and B pulse trains, and can judge the rotation direction. The direction is judged to be forward if the B pulse train turns ON when A is ON, and judged to be reverse if A turns ON when B is ON. There is also another type of incremental encoder with a zero point signal. The most commonly used incremental encoders output between 100 and 10,000 pulses per axis rotation. Refer to "ENCODER".

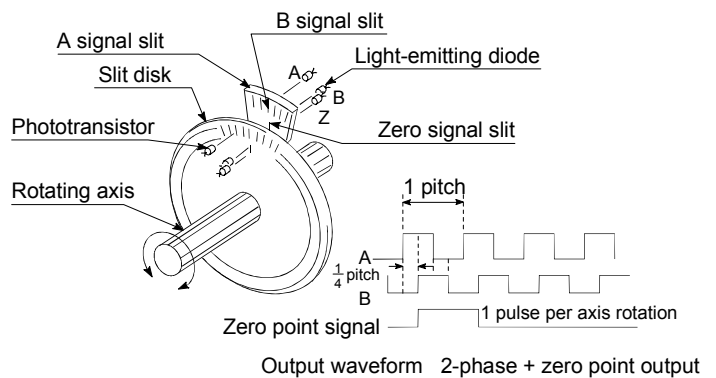

INERTIA

The property of an object, when not being affected by external forces, where it tries to maintain its current condition. The inertia moment.

INPUT TERMINAL

This is a pin connector wired by the user for inputting data to the AD75 from an external source. It is connected to the motor drive unit or machine side.

This terminal is used to output the following.

- DRIVE UNIT READY signal
- STOP signal

,etc.

The input No. Xn is not directly related to the program, so it is not used.

INTERLOCK

In this condition, the machine is blocked from moving to the next operation until the operation in progress is complete. This function is used to prevent damage to devices and malfunctioning.

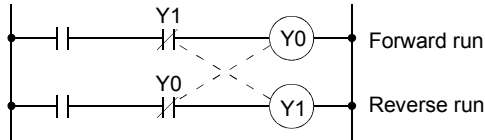

INTERPOLATION OPERATION

The operation of two motors simultaneously to carry out a composite operation. The positioning distance, acceleration/deceleration time, speed, etc., for the two motors can be freely set, but they will be combined to move the machine in a straight line, circle, etc. Interpolation operations consist of linear interpolation and circular interpolation.

INVERTER

This refers to a device to change a direct current (DC) to an alternating current (AC). The device actually changes the motor speed by changing 50Hz or 60Hz of commercial frequency to direct current once, then changing it again to a 5 to 120Hz alternating current and controlling the motor speed.

JOG

This refers to moving the tool in small steps at a time. Inching. Parameter setting is required when carrying out JOG operation.

kPPS

This is the abbreviation for "kilopulses per second". 80kPPS equals 80,000 pulses per second.

LIMIT SWITCH

This is a switch set to stop a moving object at both ends, etc., of a movement device for safety reasons. A circuit is created in which the moving body itself presses against the switch to activate the contact and forcibly shut the power OFF. For example, pressing on the actuator in the drawing below activates the internal microswitch. There are various other types.

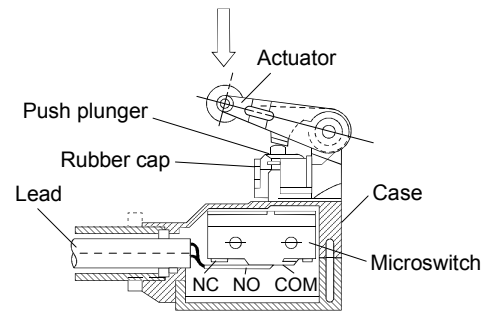

LINEAR INTERPOLATION

This automatic operation simultaneously operates the latitudinal (X) feed and longitudinal (Y) feed motors to move the machine in a diagonal line when positioning. Linear interpolation combining axis 1 and axis 2 is possible with the AD75, but the same positioning data Nos. must be used. Refer to the term "INTERPOLATION OPERATION".

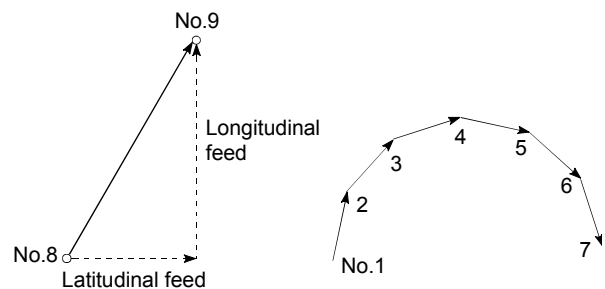

LOW-INERTIA MOTOR

This is a motor used when frequent acceleration/deceleration is repeated. Low-inertia motors are longitudinally longer, to decrease the rotor diameter and cover the torque. This enables their inertia moment to be reduced up to 1/3 that of standard motors. The ideal load inertia ratio is 1 or less.

M CODE (Machine Code)

These are auxiliary functions that interlock with the positioning operation to replace drills, tighten and loosen clamps, raise and lower welding electrodes, display various data, etc. Either of two modes can be entered when the machine code turns ON: AFTER or WITH. The machine does not move to the next positioning when the machine code is ON. M codes are turned OFF by the PLC program. Code Nos. from 1 to 32767 assigned by the user and used (1: Clamp, 2: Loosen, etc.). Comments can be written after 50 of the M codes, and they can be monitored using a peripheral device or displayed on an external display. Refer to "AFTER MODE" and "WITH MODE".

MACHINE FEED VALUE

The zero point address at the completion of the machine zero point return is stored. The current position of the machine coordinates determined by a machine having the zero point address as a reference. Even if the current value is changed, this value will not change.

MANUAL PULSE GENERATOR

The handle of this device is manually rotated to generate pulses. This device is used when manually carrying out accurate positioning.

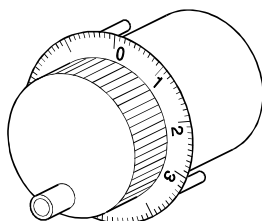

Made by Mitsubishi Electric Corp.
(model: MR-HDP01)

MASTER AXIS

When carrying out interpolation operations, this is the side on which the positioning data is executed in priority. For example, when positioning with the X axis and Y axis, the side with the largest movement distance will become the master axis, and the speed will follow that axis. The slave axis speed will be ignored.

MOVEMENT AMOUNT PER PULSE

When using mm, inch, or angle units, the movement amount is calculated and output from the machine side showing how much the motor shaft moves per pulse. Positioning accuracy in smaller units is not possible. On the motor side, the movement amount per axis rotation is normally designed as a reference, so it is calculated as follows.

Movement amount per pulse =

$$\frac{\text{P rate}}{\text{No. of pulses per encoder rotation}} \times \text{Movement amount per rotation}$$

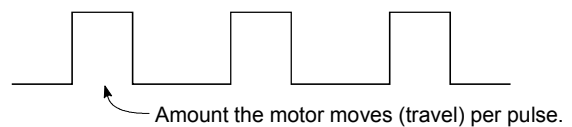

MULTI-PHASE PULSE

A combination of pulses in which 2 or more phases differ. 2-phase pulses, etc.

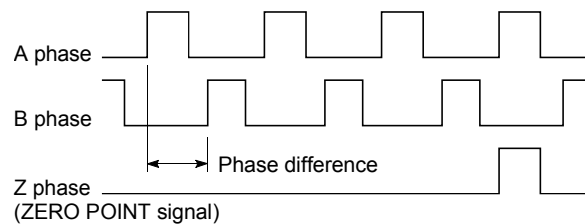

MULTIPLYING RATE SETTING

The P rate. Refer to the term "P RATE".

NEAR-POINT DOG

This is a switch placed before the zero point. When this switch turns ON, the feedrate is changed to the creep speed. Because of that, the time that this switch is ON must be long enough to allow for the time required for deceleration from the feedrate to the creep speed.

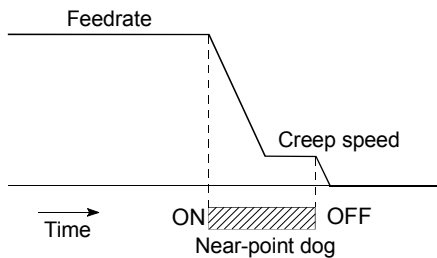

OPERATION PATTERN

The kind of operation to be carried out after executing the positioning data is determined.

- 1) If "POSITIONING COMPLETE" is selected, the operation will stop after the positioning is complete.
- 2) If "CONTINUOUS POSITIONING CONTROL" is selected, the next data No. will be automatically executed after the positioning is complete.
- 3) If "CONTINUOUS PATH CONTROL" is selected, the positioning will not be completed. Only the speed will be automatically changed, and the next data No. will be executed.

OUTPUT TERMINAL

This is a pin connector for outputting data from the AD75 to an external source. It is connected to the motor drive unit.

This terminal is used to output the following.

- Feedback pulses for both forward run and reverse run
- Start
- Deviation counter clear

The terminal Nos. are determined for each axis.

The output No. Yn is not directly related to the program, so it is not used.

OVERRIDE FUNCTION

With this function, the speed during positioning operations (current speed) can be varied between 1 and 300%.

The speed can also be changed by the same variable rate for continuous positioning with differing designated speeds.

P RATE (Pulse Rate)

A coefficient that magnifies the feedback pulses per motor shaft rotation by 2-fold, 3-fold, 1/2 or 1/3.

It is the ratio of the feed pulses and feedback pulses.

For example, when the No. of pulses per motor shaft rotation is set to 2400 pulses, and the P rate is set to 2, the result will be equivalent to 1200 pulses.

The rotation per pulse is 0.15° when 2400 pulses per rotation are set, but this becomes 0.3° when 1200 pulses. The positioning accuracy drops as the P rate is increased.

PANCAKE MOTOR

The axial dimension of this motor is approx. 100mm shorter than that of a standard motor. This type of motor is used when the servomotor installation space is narrow.

PARAMETER

This is the basic data used in positioning. Parameters are determined by the machine side design, so subsequent changes of parameters must be accompanied by changes in the machine design.

Data cannot be written during positioning. The initial parameter values are written by the maker.

POSITION CONTROL

This is mainly the control of position and dimension, such as in fixed-dimension feed, positioning, numerical control, etc. This is always controlled with feed pulses. There is also speed control.

Drive units may differ, even when the same motor is used.

POSITION DETECTION MODULE

This is an abridged version of positioning. There are two types on MELSEC, the A61LS and A62LS. This module has positioning and limit switch functions, and can use a total of 16 channels. The following drawing shows an example for 5 channels. A resolver is used in the positioning detection.

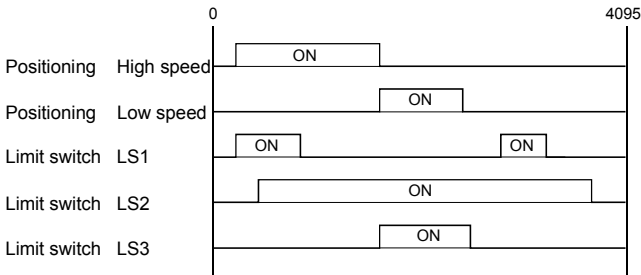

POSITION LOOP GAIN

This is the ratio of the deviation counter droop pulse count to the command pulse frequency.

$$\text{Position loop gain} = \frac{\text{Command pulse frequency}}{\text{Droop pulse count}} \text{ (1/s)}$$

The position loop gain can be set with the drive unit. Raise the gain to improve the stopping accuracy. However, overshooting will occur if the position loop gain is raised too far, and the operation will become unstable. If the position loop gain is lowered too far, the machine will stop more smoothly but the stopping error will increase.

POSITION LOOP MODE

This is one servo control mode used in positioning. It is a mode for carrying out position control. The other servo control modes are the speed loop mode for carrying out speed control, and the torque loop mode for carrying out torque control (current control).

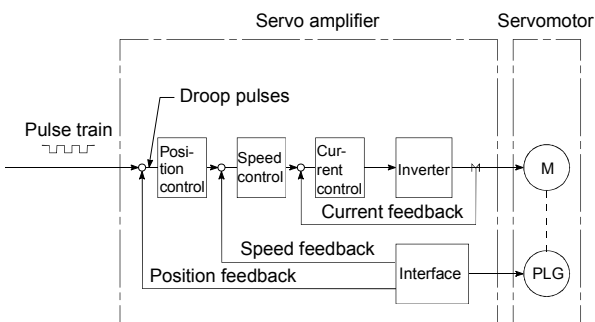

POSITIONING

Accurately moving the machine from a point to a determined point. The distance, direction, speed, etc., for that movement are designated by the user. Positioning is used in operations such as cutting sheets, drilling holes in plates, mounting parts on a PCB, and welding. Positioning is also used with robots.

POSITIONING COMPLETE SIGNAL

This is a signal that occurs when the positioning is complete. A timer set beforehand starts when this signal is output, and the machine movement stops for that time. The purpose of this signal is to start a different type of work.

The machine will not move to the next positioning while this signal is ON.

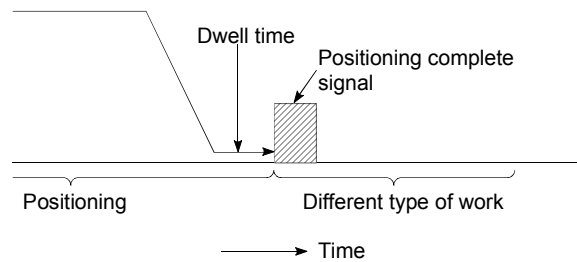

POSITIONING DATA

This is data for the user to carry out positioning. The No. of points to which positioning is carried out (the No. of addresses) is designated by the user. In the AD75, this is a maximum of 600 points. As a principle, positioning is executed in the order of the data Nos.

POSITIONING PARAMETER

This is basic data for carrying out positioning control. Types of data include control unit, movement amount per pulse, speed limit value, upper and lower stroke limit values, acceleration/deceleration time, positioning method, etc.

Parameters have an initial value, so that value is changed to match the control conditions.

POSITIONING START

This refers the act of designating a target data No. and starting the positioning.
 The operation after the positioning is complete for that data No. is determined by the data No.'s positioning pattern.

PTP Control (Point To Point Control)

This is a type of positioning control. With this control method, the points to be passed are designated at random locations on the path. Movement only to a given target positioning is requested. Path control is not required during movement from a given point to the next value.

PU (Programming Unit)

This is the abbreviation for "programming unit".

PULSE

The turning ON and OFF of the current (voltage) for short periods. A pulse train is a series of pulses. The AD75 is the module that generates the pulses.

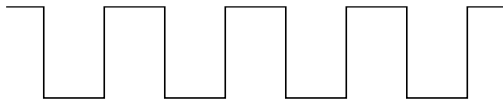

PULSE GENERATOR

This is a device that generates pulses. Examples include devices installed on the motor shaft that create pulses when the shaft rotates, and digital devices. 1-phase types output one pulse train. 2-phase types output two pulse trains with a phase difference. From 600 to 1,000,000 pulses can be output per shaft rotation. Generators with a ZERO POINT signal function to output 1 or 2 pulses per shaft rotation. Abbreviated as PLG. Refer to the term "ENCODER".

PULSE OUTPUT MODE

There are two methods used to issue forward run and reverse run commands to the servomotor. The type used differs according to the machine maker. In type A, the forward run pulses and reverse run pulses are output from separate terminals. In type B, the forward run pulses and reverse run pulses are output from the same terminal, and a forward/reverse run identification signal is output from another terminal.

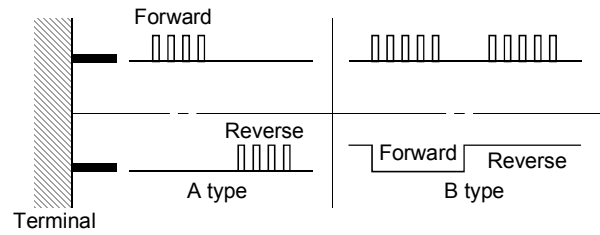

READY

This means that preparation is complete.

REAL-TIME AUTO TUNING (Real-time Automatic Tuning)

Refer to "AUTO TUNING".

REFERENCE AXIS SPEED

This is the speed of the reference axis during interpolation operations.

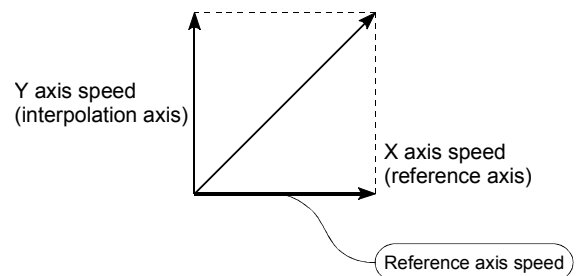

REGENERATIVE BRAKE OPTION

This function is an option. It is used when carrying out highly repetitive acceleration/deceleration. Refer to "EXTERNAL REGENERATIVE RESISTOR".

RESOLVER

This device detects the angle by resolving the two voltages of the analog input. Also called a 2-phase synchro. For a 1-phase voltage input, the axis rotation angle is converted into a perpendicular 2-phase voltage (analog voltage) and output.

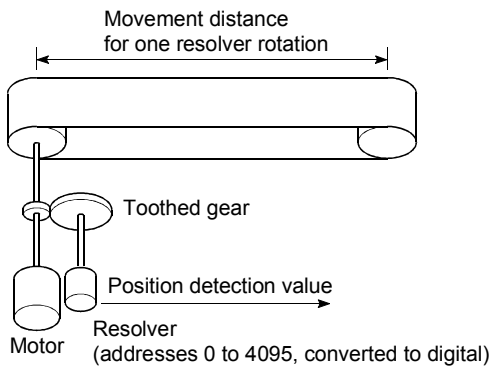

RLS SIGNAL (Reverse Limit Signal)

This is the input signal that notifies the user that the limit switch (b contact configuration, normally continuity) installed at the lower limit of the positioning control enabled range was activated. The positioning operation stops when the RLS signal turns OFF (non-continuity).

ROTARY TABLE

A round table on which the workpiece is placed. Positioning control is carried out while rotating the workpiece in a 360° range.

S-CURVE ACCELERATION/DECELERATION

In this pattern, the acceleration and deceleration follow a sine curve, and the movement is smooth. The S-curve ratio can be set from 1 to 100%.

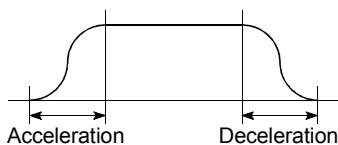

SERVO AMPLIFIER

Refer to the term "DRIVE UNIT".

SERVO LOCK

In positioning using a servomotor, stepping motor, etc., working power is required to hold the machine at the stop position. (The position will be lost if the machine is moved by external power.) This kind of state is called servo lock or servo lock torque.

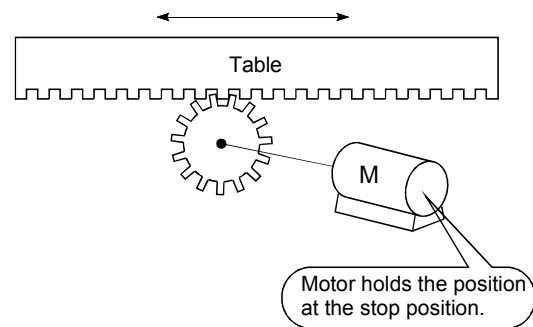

SERVO ON

The servo amplifier will not operate if the servo amplifier is in a normal state and this servo ON signal is OFF.

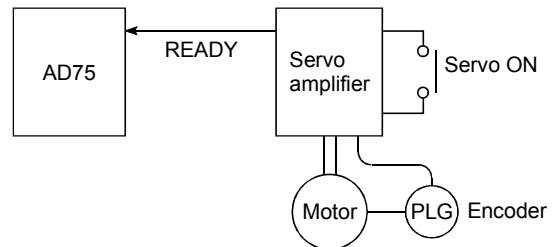

SERVOMOTOR

A motor that rotates true to the command. Servomotors are highly responsive, and can carry out frequent high-speed and high-accuracy starts and stops. DC and AC types are available, as well as large-capacity motors. A pulse encoder accessory for speed detection is common, and feedback control is often carried out.

SETTING UNIT

This is one setting item of the positioning reference parameters. The unit to be used is designated as mm, inch, degree, or pulse.

SKIP FUNCTION

When a SKIP signal is input, the positioning being executed is interrupted, the motor is deceleration stopped, and the next positioning is automatically carried out.

SLAVE AXIS

During interpolation operation, the positioning data is partially ignored on this side. This axis is moved by the master axis data.

SPEED CHANGEOVER CONTROL

With this control, positioning is carried out to the end point of the movement amount while changing the speed at the speed changeover point during positioning control.

SPEED CONTROL

Speed control is mainly carried out with the servomotor. It is an application for grindstone rotation, welding speed, feedrate, etc. Speed control differs from position control in that the current position (address) is not controlled. Drive units may differ, even when the same motor is used.

SPEED INTEGRAL COMPENSATION

This is one item in the servo amplifier's parameters. It is used to raise the frequency response during speed control, and improve transient characteristics.

When adjusting the speed loop gain, raising this value is effective if the overshooting during acceleration/deceleration remains large.

This compensation is set in ms units.

SPEED LIMIT VALUE

This is the max. speed for positioning. Even if other data is mistakenly set to a higher speed than this, the positioning will be carried out at this speed limit value when it is set in the parameters. The acceleration time becomes the time to accelerate from a stopped state to the speed limit value, and the deceleration time becomes the time to decelerate from the speed limit value to a stopped state.

SPEED LOOP GAIN

This is one item in the servo amplifier's parameters. It expresses the speed of the control response during speed control. When the load inertia moment ratio increases, the control system speed response decreases and the operation may become unstable. If this happens, the operation can be improved by raising this setting value.

The overshoot will become larger if the speed loop gain is raised too far, and motor vibration noise will occur during operation and when stopped.

SPEED LOOP MODE

This is one servo control mode used in positioning. It is a mode for carrying out speed control. Refer to "POSITION LOOP MODE".

SPEED/POSITION CONTROL CHANGEOVER MODE

This is one method used for positioning. It is an application for operations such as high-speed movement to a point unrelated to positioning, then set dimension movement from the changeover signal activation point.

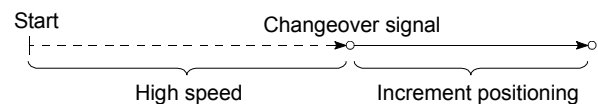

START COMPLETE

This signal gives an immediate response notifying the user that the AD75 that was started is now in a normal state and can start positioning.

STARTING AXIS

One of the AD75 axis system axes (axis 1, axis 2, or axis 3) or the reference axis for the interpolation operation is designated as the starting axis.

STATUS

Data showing the state of the machine. Collectively refers to signals that turn ON when the battery voltage drops, during zero point requests, during dwell time, etc.

STEP FUNCTION

When the operation is designed so that several positioning data Nos. are consecutively run, this function can be used to carry out a test operation for 1 data item at a time.

STEP OUT

Stepping motors rotate in proportion to the No. of pulses (frequency), but the motor's rotation will deviate if the load is too large for the motor. This is called step out. If step out occurs, the motor must be replaced by one with a larger torque. Step out causes the positioning error to increase.

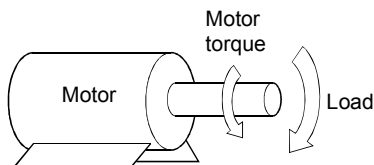

STEPPING MOTOR

A motor that rotates a given angle (example: 0.15°) when 1 pulse is generated.

For that reason, a rotation proportional to the No. of pulses can be obtained. 2-phase to 5-phase stepping motors are available. In the 3-phase type, the rotor rotates in order from A to C when a voltage is applied. Often found in compact motors, stepping motors rotate accurately without feedback. Be careful of step out when overloaded.

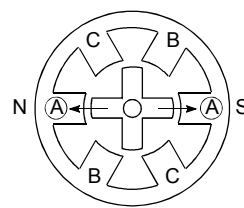

1) First, the A phase is excited by a pulse.

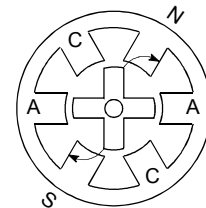

2) When the B phase is then excited, the force works in the direction shown by the arrows.

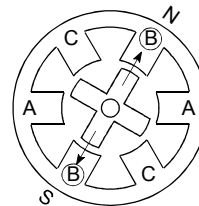

3) The nearest tooth to the B phase is attracted, and the rotation stops.

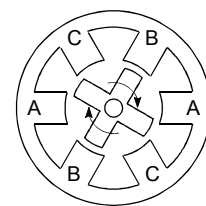

4) As the excitation phase is continuously changed, the rotor rotates in a clockwise direction.

STOP SETTling TIME

Refer to the term "Dwell Time".

STOP SIGNAL

In positioning control, this is the input signal X that directly stops the operation from an external source.

The operation stops when the external STOP signal (a contact) turns ON (continuity), and X turns ON.

STOPPER STOP

This is one machine zero point return method. With this method, a stopper is established at the zero point, and the operation is stopped when the machine presses against it. Motor burning would occur or the stopper would be damaged if the machine were left in that state. There are two methods to prevent this; a timer can be used to shut OFF the motor after a fixed time, or the motor can be stopped by limiting sudden increase in the motor torque when the machine presses against the stopper.

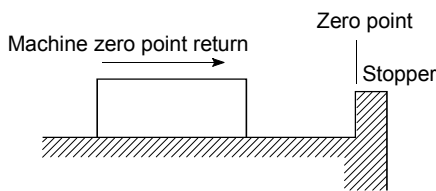

STROKE

The stroke is the variation in the operation by the distance from a stopped state to the next stopped state after a movement.

STROKE LIMIT

This is the range in which a positioning operation is possible, or the range in which the machine can be moved without damage occurring. (Movement outside this range is possible in the manual operation.) For operations using a worm gear, the stroke limit is determined by the length of the screw. For operations using a fixed-dimension feed, it is determined by the max. dimension to be cut. The upper and lower limits are set in the parameters, but a separate limit switch should be established and an emergency stop circuit outside the PLC should be created. Refer to the term "LIMIT SWITCH".

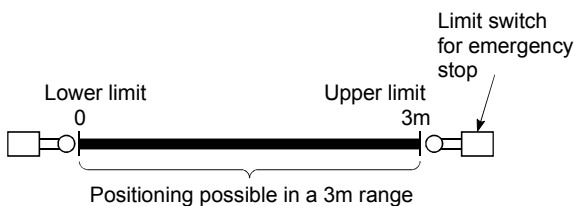

SUDDEN STOP

A stop carried out in a shorter time than the deceleration time designated in the parameters.

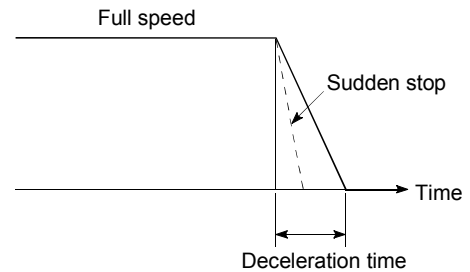

TEACHING

When the positioning address is uncertain, or gauging is required, this function is used by the user to search for and teach the position to the machine. For example, complex addresses such as drawings can be taught by tracing a model, and the positioning operation can be reproduced.

TEACHING UNIT

This is a device capable of writing, reading, running, and monitoring data. It is used connected to the AD75. The model is AD75TU.

TORQUE CONTROL

In this function, a limit is established for the resistance torque applied to the motor. The power is turned OFF if torque exceeding that value is applied to the motor. When excessive torque is applied to a motor, it causes the current to suddenly increase. Motor burning and other stress on the motor occurs, and the life of the motor is shortened. This function utilizes the sudden increase in the torque when the machine returns to the zero point to issue a command to stop the motor.

TORQUE LOOP MODE

Also called the current loop mode. Refer to "POSITIONING LOOP MODE".

TORQUE RIPPLE

Torque width variations, deviations in the torque.

TRACKING FUNCTION

In this function, positioning is carried out at a speed relative to a moving target object by inputting the movement amount from an external encoder and adding it to the servo command value.

TURNTABLE

A rotating table, which is turned using power. The table is used divided from one 360° rotation into the required locations for work. The positioning control unit is "degree".

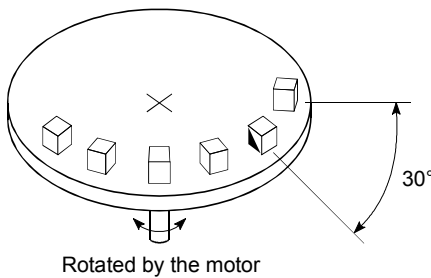

UNIT SETTING

This is the setting of the unit for the actual address to which positioning is required, or for the movement amount. The following units can be set: mm, inch, degree and pulse. The initial value in the parameters is a pulse unit.

WARNING

A warning is output as a warning code in when an abnormality is detected that is not serious enough to require cancellation or stoppage of the positioning operation. Warnings are handled differently than errors.

WITH MODE

This is the mode that outputs the M code before the start of the positioning. This mode turns ON at the positioning start, enabling voltage to be applied to the welding electrodes, display of positioning speeds, etc. Refer to the term "AFTER MODE".

WORM GEAR

This is the basic screw in mechanisms that position using screw rotation. Ball screws are often used to reduce backlash and dimension error.

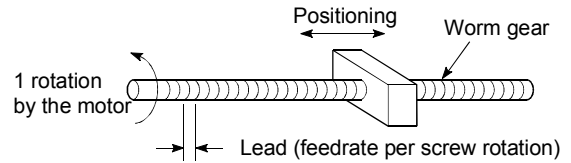

XY TABLE

This is a device that moves a table in the X (latitudinal) and Y (longitudinal) directions so that positioning can be carried out easily. There are also commercially available products.

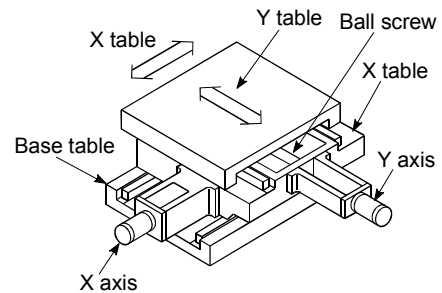

Z PHASE

Also called "PG zero". Refer to "ZERO POINT SIGNAL".

ZERO POINT

This is the reference position for positioning. Positioning cannot start without a reference point. The zero point is normally set to the upper or lower stroke limit.

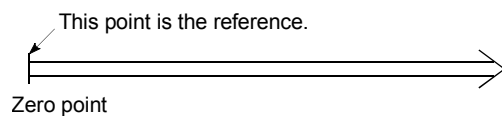

ZERO POINT RETURN METHOD

The zero point return methods are shown below. The method used depends on the machine structure, stopping accuracy, etc. Machine zero point returns can be carried out when the zero point return parameters are written.

- 1) Near-point dog method.
- 2) Stopper stop method
- 3) Count method

ZERO POINT RETURN PARAMETER

This parameter is required when returning to the zero point. It is determined by the machine side design, so subsequent changes of this parameter must be accompanied by changes in the machine design.

The zero point is the reference for positioning operations, so if the zero point is lost due to a power failure during positioning, or because the power is turned OFF and the machine is moved manually, etc., it can be restored by carrying out a machine zero point return.

When a machine zero point return command is issued, the machine will move in search of the near-point dog regardless of the current value, and will stop at the zero point. At this time, the current value will be rewritten to the zero point address. Data cannot be written during positioning. With the AD75, data is always written for all axes (from 1 to 3 axes). Refer to the term "NEAR-POINT DOG".

ZERO POINT RETURN REQUEST

This signal turns ON when there is an error with the AD75. It will turn ON in the following situations.

- 1) When the power is turned ON.
- 2) When the PLC READY signal turns from OFF to ON.
- 3) When the machine zero point return starts.
- 4) When the drive unit READY signal turns from ON to OFF.

The user judges whether to carry out a machine zero point return in the above situations.

ZERO POINT SHIFT FUNCTION

The zero point position can be shifted to the plus or minus direction by executing a machine zero point return and determining a shift amount for the position at the completion of the machine zero point return.

A zero point can be set at a position besides the zero point position, or outside the dog switch.

ZERO POINT SIGNAL

This refers to PG0 of the pulse generator (encoder) (one detection per shaft rotation). It also called "Z phase". Refer to the term "PULSE GENERATOR".

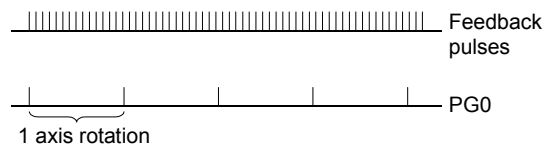

Appendix 11 Positioning control troubleshooting

Trouble type	Questions/Trouble	Remedy	No.
Parameter	Display reads "FFFF _H " when a parameter is read with a AD75 software package.	The PLC CPU power was turned OFF or the PLC CPU was reset, etc., during flash ROM writing, which deleted the data in the flash ROM. Initialize the parameters, and reset the required parameters. (Refer to section "13.2 Parameter initialization function" for details.)	1
	How can the parameters be returned to their initial values?	Set the [Cd.10] Parameter initialization request to "1". (Refer to section "13.2 Parameter initialization function" for details.)	2
	A parameter error occurred although the parameter was set correctly in the AD75 software package.	The parameter may have been overwritten in the sequence program. Review the sequence program.	3
Hardware stroke limit	The machine overruns if operating at high speeds when the hardware stroke limit range is exceeded.	In the AD75, deceleration stops are executed after the machine exceeds hardware stroke limit range. Because of this, more time is required for the deceleration stop as the speed increases, and the overrun becomes larger. (The deceleration time becomes shorter at lower speeds, so the overrun becomes smaller.)	4
	When the machine exceeded the hardware stroke limit range, positioning toward inside the range was started, but the machine did not start.	Use a "JOG operation" or "Manual pulse generator operation" to return the machine to inside the hardware stroke limit range. (When the hardware stroke limit range is exceeded, positioning will not start toward inside the range even when so commanded. Once the range is exceeded, a return to inside the range can only be executed using a "JOG operation" or "Manual pulse generator operation".)	5
Degree	Exactly one rotation is required, but the setting range for a "degree" unit setting is "0 to 359.999...". Won't the rotation deviate by "0.00...1"?	Designate "360.000" in the INC control. The motor will make exactly one rotation.	6
Movement amount per pulse	If the "movement amount per pulse" is calculated as written in the manual, settings smaller than the basic parameter setting range cannot be carried out.	Set "movement amount per pulse" in the AD75 using the three parameter values of [Pr.2] to [Pr.4]. Try setting the values following the explanations for each parameter.	7
Override	Will an override setting value written before starting be valid?	It will be valid.	8
	During tracking control, will the override still be valid after the point is passed?	It will still be valid.	9
	How can the override be canceled?	Set the "[Cd.18] Positioning operation speed override" to "100".	10

Trouble type	Questions/Trouble	Remedy	No.
Acceleration/deceleration time	How can the deceleration stop time during stopping be shortened using the hardware stroke limit?	Set "1: Sudden stop" in the "[Pr.38] Stop group 1 sudden stop selection", and reduce the setting value of "[Pr.37] Sudden stop deceleration time".	11
	The motor does not operate at "60000ms" although the acceleration/deceleration time is set to "60000ms".	The value set for the acceleration/deceleration time is the time required for the machine to accelerate from speed "0" to the value set in "[Pr.7] Speed limit value". Because of that, the acceleration/deceleration time will also be shorter than "60000ms" if the command speed value is smaller than the "[Pr.7] Speed limit value". (Refer to the explanation for [Pr.8] for details.)	12
	Can each acceleration/deceleration time be individually set to trapezoidal or S-curve acceleration/deceleration?	The trapezoidal and S-curve acceleration/deceleration processing is a common setting for all acceleration/deceleration times, so individual setting is not possible. (Refer to the section "12.6.7 Acceleration/deceleration process function".)	13
	The machine starts and stops suddenly when carrying out JOG operations and positioning operations. (Using an MR-J2S servo amplifier.)	Review the parameter settings for acceleration/deceleration time, speed limit value, JOG speed limit value, JOG acceleration/deceleration time, etc.	14
	How can a value higher than "65536ms" be set in the acceleration/deceleration time?	A value up to "8388608ms" can be set when the "[Pr.25] Size selection for acceleration/deceleration time" is set to "1".	15
Simplified absolute position detection system	Are simplified absolute position detection system possible in the A1SD75P and AD75P models?	They are possible if the models are used in combination with a Mitsubishi "AC Servo". (Refer to the "AC servo User's Manual" for details.)	16
Positional deviation	The physical position deviates from the commanded position, although the positioning is complete (and the monitored current position is correct).	If the deviation counter value is not "0", the servo side is still moving. Increase the torque.	17
	When positioning to "6300mm" is commanded with 1-axis direct control (ABS type), the machine position is "6299mm" when the positioning is complete.	Depending on the "Movement amount per pulse" setting, the positioning may be insufficient by the error amount when positioning is attempted to an address for which the No. of pulses was generated. This is because the movement is controlled so as not to exceed the designated address when the error amount movement amount is generated to the AD75. In this situation, adjust the "Movement amount per pulse" setting so the positioning completes at the correct position.	18
Electronic gear	A setting of "1 μ m = 1pulse" is required in the following system. <ul style="list-style-type: none"> Ball screw pitch = 10mm No. of feedback pulses = 8192 pulse 	In this case, the following values will result. <ul style="list-style-type: none"> No. of pulses per rotation = 8192 Movement amount per rotation = 10000 Unit magnification = 10 Therefore, the "Movement amount per pulse" will become "1.2207 μ m". This value is fixed by the machine system, so it cannot be changed. Thus, the setting "1 μ m = 1 pulse" cannot be achieved.	19

Trouble type	Questions/Trouble	Remedy	No.
Error compensation	<p>The machine only moves to "10081230", although positioning with a command value of "10081234" carried out.</p> <p>How can the error be compensated?</p> <p>The following values are currently set.</p> <ul style="list-style-type: none"> Pr.2 No. of pulses per rotation = 8192 Pr.3 Movement amount per rotation = 8000 	<p>Reset Pr.3 and Pr.2 in the following order.</p> <ol style="list-style-type: none"> 1) Calculate "8192/8000 × 10081230/10081234". 2) Obtain the reduced value. 3) Set the numerator in "Pr.3 Movement amount per rotation", and the denominator in "Pr.2 No. of pulses per rotation". 	20
Zero point return	<p>When carrying out a count method machine zero point return, the message "Leave Sufficient Distance From The Zero Point Position To The Near-Point Dog OFF." appears. Is there a problem if the distance is short?</p>	<p>The near-point dog must be set to turn OFF at a position after the zero point is passed. (When the machine zero point return is started on the near-point dog ON in a count method machine zero point return, the machine enters a normal zero point return operation after returning to the near-point dog OFF region.) (If the near-point dog is turned OFF before the zero point, and the machine zero point return is started between the near-point dog OFF position and the zero point, the machine will mistakenly interpret that its current position is before the near-point dog ON position, and it will pass over the zero point and continue moving.)</p>	21
	<p>In the near-point dog method machine zero point returns, the stop positions are not uniform.</p>	<p>Carry out the following measures.</p> <ol style="list-style-type: none"> 1) Separate the near-point dog signal and zero point signal detection positions. 2) Lower the values in "Pr.48 Zero point return speed" and "Pr.49 Creep speed". 3) Confirm whether the zero point signal and near-point dog signal turn ON normally. 4) Check that there is no play (backlash) in the machine system. 	22
	<p>Can the machine zero point return be carried out with the zero point return retry function when it is started with the near-point dog ON and the upper/lower limit OFF?</p>	<p>A "Hardware stroke limit error" will occur and the operation will not be carried out. (The machine will interpret any position where the near-point dog is ON as being within the working range, and that the upper/lower limit is ON.)</p>	23
	<p>Are ABS and INC positioning possible without carrying out a zero point return?</p>	<p>They are possible. In this case, the position where the power is turned ON is handled as the current feed position "0".</p>	24
	<p>After a zero point return, the zero point return request flag sometimes turns ON for no apparent reason.</p>	<p>The zero point return request flag turns ON in the following cases.</p> <ol style="list-style-type: none"> 1) When the power is turned ON. 2) When the PLC READY signal turns from OFF to ON. 3) When a machine zero point return is carried out. 4) When the drive unit power is turned OFF. <p>If no problem is found when the above are checked, then it is possible that the communication is being interrupted by "a fault in the cable", "noise influence", etc.</p>	25
	<p>The zero point return complete flag (Md.40 Status: b4) sometimes turns ON when it shouldn't be ON.</p>	<p>Check whether the drive unit READY signal is weak or the power supply is unstable.</p>	26

Trouble type	Questions/Trouble	Remedy	No.
Start	The positioning start signal [Y10] is kept ON until the BUSY signal is OFF, but is there any problem with turning it OFF before the BUSY signal turns OFF?	After the BUSY signal turns ON, there is no problem with turning [Y10] OFF before the BUSY signal turns OFF. (The AD75 detects the rising edge (OFF → ON) of the positioning start signal [Y10].)	27
	The operation will not start even when the start signal is turned ON.	Check the "[Md.35] axis operation status" and "[Md.33] axis error No". Review the sequence program and normalize the start timing.	28
Stop	How many ms should the axis stop signal [Y13] be turned ON for?	The signal should be turned ON at 4ms or more. (If possible, set the signal so it does not turn ON only momentarily, but instead stays ON until the BUSY signal turns OFF. This will keep the stop signal from skipping.)	29
	How can a sudden stop be selected?	Set "1: Sudden stop" in the parameter from [Pr.38] to [Pr.40] corresponding to the stop group, and reduce the setting value of "[Pr.37] Sudden stop deceleration time".	30
	"Normal deceleration stop" was selected in "[Pr.40] Stop group 3 sudden stop selection", and Y stop was turned ON. If the [Pr.40] setting is changed to "sudden stop" during a deceleration stop, and the Y stop signal turns from OFF to ON, will the operation change to a sudden stop from that point?	The operation will not change. Even if the same stop factor is input again during the deceleration stop, it will be ignored. The same deceleration stop process used when the stop signal was first input will be continued. (This also applies for [Pr.38] and [Pr.39].)	31
Circular interpolation	ABS type circular interpolation operates normally, but a vertically oblong circle results when INC type circular interpolation is carried out.	The address designation may be incorrect. When carrying out INC type circular interpolation, designate the relative addresses from the starting point of both the center point and end point.	32
Speed/position changeover control	Can the speed be changed during speed control and position control by speed/position changeover control?	The speed during speed control and position control cannot be set separately, but a speed change is possible if executed after the speed/position changeover signal turns ON.	33
JOG operation	Even if the JOG start signal is turned ON, the response until it turns ON is sometimes slow.	Either of the following is possible. 1) The sequence program may be incorrect. Check by creating a test program in which the JOG start signal is turned ON only. 2) If the machine is hitting something when the torque setting is low, it may be trying to move by JOG operation in the opposite direction. In this case, the machine will start moving only after the internal droop pulses have been reached 0 in the counter, even if the JOG start signal has been turned ON. This makes it seem that the response is slow.	34
	The operation is not carried out at the set JOG speed, although the speed limit value has not been reached.	Either of the following is possible. 1) The JOG start signal may be chattering. Monitor the JOG start signal to confirm whether it is chattering. 2) The "[Pr.32] JOG speed limit value" may not be appropriate. Review the setting value and carry out the JOG operation again.	35
	When a JOG operation is attempted, an error results and the machine does not move.	The "[Pr.32] JOG speed limit value" may be larger than the "[Pr.7] Speed limit value". Review the parameters and carry out the JOG operation again.	36

Trouble type	Questions/Trouble	Remedy	No.
Manual pulse generator operation	Is it possible to count the pulses when the B phase is set to "1", and only A phase pulses are input?	Not possible. (The AD75 counts 1, 0, 1, 0.)	37
	Can a manual pulse generator other than the Mitsubishi MR-HDP01 be used?	Other manual pulse generators can be used if they conform to section "3.5 Specifications of input/output interfaces with external devices."	38
	Can one manual pulse generator be operated connected to several AD75 modules?	This is possible if the system conforms to the electrical specifications.	39
Current value change	The BUSY signal is not canceled by the current value change. How can it be canceled?	The BUSY signal may remain if the scan time is long. Use a complete signal to check whether the new value has been executed.	40
AD75 READY signal	The AD75 READY signal does not turn OFF even when the PLC READY signal [Y1D] is turned ON.	"A parameter error" has occurred. Confirm the error No. in the error history, and correct the parameter.	41
M code ON signal	Is there any problem with setting an M code ON signal OFF request in the next scan after the M code ON signal ON?	The AD75 checks the M code ON signal OFF request every "56.8ms", so there is a possibility that the M code ON signal OFF may be delayed by a maximum of "56.8ms" after the M code ON signal ON, even if an M code ON signal OFF request is set.	42
In-position signal	Must an in-position signal always be wired?	The in-position signal is not particularly used in the AD75 processing, so it does not always have to be wired. (In the AD75, the input in-position signal is only output in the monitor area.)	43
Deviation counter clear	How long is the output time for the deviation counter clear signal?	"10ms".	44
	Is a deviation counter clear signal output when the positioning is complete?	A signal is not output. The only time the AD75 outputs a deviation counter clear signal is for a machine zero point return.	45
	How can a deviation counter clear signal be output?	The AD75 does not output a deviation counter clear signal except for machine zero point returns.	46
Module	Where is the current version of the AD75 written?	The version is shown on the label on the front of the module. (Refer to section "4.1.2 Names of each part".)	47
	Is it possible that the delivered module is a different version than the version delivered 1 year ago?	That is possible.	48
	Error 537 (PLC READY OFF start) occurred when the new module was connected. (The sequence program is the same.)	The parameters in the module may differ. Check if the AD75 READY signal [X0] turns OFF when the PLC READY signal [Y1D] turns ON. When the PLC READY signal is ON but the AD75 READY signal is ON, the parameter error has occurred. Check the error code and modify the parameter with the error.	49
Motor	The motor only rotates in one direction.	The parameter settings on the AD75 side may not match those on the servo side. Check the parameter settings.	50
	Can the current motor speed be monitored?	The speed shown on the AD75 monitor is calculated from the No. of pulses output from the module. Thus, the actual motor speed cannot be monitored. ("[Md.31] Feedrate" monitors the commanded speed. It does not show the actual speed.)	51
AD75 software package	Can AD75P□-S3 models be used by SW0IVD-AD75P-E models?	No.	52
Block transmission	How can it be judged that the block transmission was carried out normally?	If the transfer is carried out normally, "0" will be stored in buffer memory "5103". If the transfer ended abnormally, a warning will be stored in the "[Md.34] Axis warning No".	53

Trouble type	Questions/Trouble	Remedy	No.
Writing from the computer link module	How can the address be designated when writing data from the computer link module to the AD75?	Designate an address in the AD75 buffer memory address "0" that will be interpreted as the computer link module buffer memory address "800H". (Refer to the User's Manual for the module being used for details.)	54
Error/warning	Error 997 (speed selection at zero point shift error) occurred. What does "OPR" mean?	"OPR" stands for "Original Position Return", or in other words, a zero point return.	55
	Error 938 (backlash compensation amount error 2) occurs even when the backlash compensation value is set to "1".	$0 \leq \frac{\text{Backlash compensation value}}{\text{Movement amount per pulse}} \leq 255$ Setting is not possible if the above equation is not satisfied. Adjust by setting "[Pr.4] Unit magnification" to 10-fold (or 100-fold, or 1000-fold), and setting "[Pr.3] Movement amount per rotation" to 1/10 (or 1/100, or 1/1000).	56
	When a JOG operation is attempted, errors such as error 104 (hardware stroke limit+) or error 105 (hardware stroke limit-) occur and the machine does not move.	The hardware stroke limit wiring has probably not been carried out. Refer to section "12.4.4 Hardware stroke limit function" for details, and wire accordingly.	57
	Error 971 (tracking control mode error) occurs. What could be causing the error?	A value besides "0" or "1" may be set in the "[Pr.44] Near pass mode selection for path control". Review the set sequence program, and reset the correct parameters.	58
	Error 997 (speed selection at zero point shift error) appears when the PLC READY signal [Y1D] turns from OFF to ON.	A value besides "0" or "1" may be set in the "[Pr.57] Speed designation during zero point shift". Review the set sequence program, and reset the correct parameters.	59
	When the start signal was turned ON immediately after the stop signal ON, warning 100 (start during operation) was detected, and the start was ignored.	The AD75 starts the deceleration stop process when the stop signal ON is detected. Thus, the machine interprets that "positioning is still being executed" immediately after the stop signal ON. Even if the start signal is turned ON at that time, the start request will be ignored and warning 100 will occur.	60
	Does warning 500 (deceleration and stop speed change) occur only during "stop deceleration" and "automatically deceleration"? Is there any problem if the operation is continued in that state without resetting the error?	The warning occurs only at those times mentioned at the left. Because this is a warning, there is no problem if the operation can be continued without resetting the error. (When the speed is changed using the override, the new value will not be reflected on the data being executed, but will be reflected from the next start.)	61
Positioning complete signal	Position control was performed but positioning complete signal does not turn ON.	Positioning may not have been completed normally due to occurrence of a stop cause. Check the axis monitor "[Md.35] Axis operation status" after the BUSY signal has turned OFF. During stop: The stop signal has turned ON during positioning. Check the condition under which the stop signal (Y stop, external stop) turns ON. During error occurrence: An error occurred during positioning. Confirm the error occurrence cause from "[Md.33] Axis error No.".	62
		The setting of detailed parameter 2 "Positioning completion signal output time" is 0 or shorter than the scan time. Set the time that can be detected securely in the sequence program.	63

Appendix 12 List of buffer memory addresses

The following shows the relation between the buffer memory addresses and the various items.
(Any address not given in the list must not be used. If used, the system may not operate correctly.)

Buffer memory address			Item	Memory area
Axis 1	Axis 2	Axis 3		
0	150	300	Pr.1 Unit setting	Basic parameters 1
1	151	301	Pr.2 No. of pulses per rotation (Ap)	
2	152	302	Pr.3 Movement amount per rotation (Al)	
3	153	303	Pr.4 Unit magnification (Am)	
4	154	304	Pr.5 Pulse output mode	
5	155	305	Pr.6 Rotation direction setting	
6	156	306	Pr.7 Speed limit value	Basic parameters 2
7	157	307		
8	158	308	Pr.8 Acceleration time 0	
9	159	309		
10	160	310	Pr.9 Deceleration time 0	
11	161	311		
12	162	312	Pr.10 Bias speed at start	
13	163	313		
14	164	314	Pr.11 Stepping motor mode selection	Positioning parameters
15	165	315	Pr.12 Backlash compensation amount	
16	166	316	Pr.13 Software stroke limit upper limit value	
17	167	317		
18	168	318	Pr.14 Software stroke limit lower limit value	
19	169	319		
20	170	320	Pr.15 Software stroke limit selection	
21	171	321	Pr.16 Software stroke limit valid/invalid setting	
22	172	322	Pr.17 Command in-position width	
23	173	323		
24	174	324	Pr.18 Torque limit setting value	
25	175	325	Pr.19 M code ON signal output timing	
26	176	326	Pr.20 Speed changeover mode	
27	177	327	Pr.21 Interpolation speed designation method	
28	178	328	Pr.22 Current feed value during speed control	
29	179	329	Pr.23 Manual pulse generator selection	
30	180	330	Pr.24 Logic selection for pulse output to the drive unit	
31	181	331	Pr.25 Size selection for acceleration/deceleration time	
36	186	336	Pr.26 Acceleration time 1	Detailed parameters 2
37	187	337		
38	188	338	Pr.27 Acceleration time 2	
39	189	339		
40	190	340	Pr.28 Acceleration time 3	
41	191	341		
42	192	342	Pr.29 Deceleration time 1	
43	193	343		

Buffer memory address			Item	Memory area	
Axis 1	Axis 2	Axis 3			
44	194	344	Pr.30 Deceleration time 2	Detailed parameters 2 Positioning parameters	
45	195	345			
46	196	346	Pr.31 Deceleration time 3		
47	197	347			
48	198	348	Pr.32 JOG speed limit value		
49	199	349			
50	200	350	Pr.33 JOG operation acceleration time selection		
51	201	351	Pr.34 JOG operation deceleration time selection		
52	202	352	Pr.35 Acceleration/deceleration process selection		
53	203	353	Pr.36 S-curve ratio		
54	204	354	Pr.37 Sudden stop deceleration time		
55	205	353			
56	206	356	Pr.38 Stop group 1 sudden stop selection		
57	207	357	Pr.39 Stop group 2 sudden stop selection		
58	208	358	Pr.40 Stop group 3 sudden stop selection		
59	209	359	Pr.41 Positioning complete signal output time		
60	210	360	Pr.42 Allowable circular interpolation error width		
61	211	361			
62	212	362	Pr.43 External start function selection		
66	216	366	Pr.44 Near pass mode selection for path control		
70	220	370	Pr.45 Zero point return method		Zero point return basic parameters
71	221	371	Pr.46 Zero point return direction		
72	222	372	Pr.47 Zero point address		
73	223	373			
74	224	374	Pr.48 Zero point return speed		
75	225	375			
76	226	376	Pr.49 Creep speed		
77	227	377			
78	228	378	Pr.50 Zero point return retry		
79	229	379	Pr.51 Zero point return dwell time		
80	230	380	Pr.52 Setting for the movement amount after near-point dog ON		
81	231	381			
82	232	382	Pr.53 Zero point return acceleration time selection	Zero point return detailed parameters	
83	233	383	Pr.54 Zero point return deceleration time selection		
84	234	384	Pr.55 Zero point shift amount		
85	235	385			
86	236	386	Pr.56 Zero point return torque limit value		
88	238	388	Pr.57 Speed designation during zero point shift		
89	239	389	Pr.58 Dwell time during zero point return retry		Zero point return parameters

Buffer memory address																Item	Memory area	
Common for axis 1, axis 2, and axis 3																		
450																Md.1	In test mode flag	System monitor data Monitor data
451																Md.2	Module name	
452 453 454 455																Md.3	OS type	
456 457																Md.4	OS version	
460																Md.5	Clock data (hour: minute)	
461																Md.6	Clock data (second: 100 ms)	
(0)	(1)	(2)	(3)	(4)	(5)	(6)	(7)	(8)	(9)	(10)	(11)	(12)	(13)	(14)	(15)	(pointer No.)		
462	467	472	477	482	487	492	497	502	507	512	517	522	527	532	537	Md.7	Start axis	
463	468	473	478	483	488	493	498	503	508	513	518	523	528	533	538	Md.8	Operation type	
464	469	474	479	484	489	494	499	504	509	514	519	524	529	534	539	Md.9	Start time (Hour: minute)	
465	470	475	480	485	490	495	500	505	510	515	520	525	530	535	540	Md.10	Start time (Second: 100 ms)	
466	471	476	481	486	491	496	501	506	511	516	521	526	531	536	541	Md.11	Error judgment	
542																Md.12	Start history pointer	
(0)	(1)	(2)	(3)	(4)	(5)	(6)	(7)	(8)	(9)	(10)	(11)	(12)	(13)	(14)	(15)	(pointer No.)		
533	548	553	558	563	568	573	578	583	588	593	598	603	608	613	618	Md.13	Start axis	
534	549	554	559	564	569	574	579	584	589	594	599	604	609	614	619	Md.14	Operation type	
535	550	555	560	565	570	575	580	585	590	595	600	605	610	615	620	Md.15	Start time (Hour: minute)	
536	551	556	561	566	571	576	581	586	591	596	601	606	611	616	621	Md.16	Start time (Second: 100 ms)	
537	552	557	562	567	572	577	582	587	592	597	602	607	612	617	622	Md.17	Error judgment	
623																Md.18	Start history pointer at error	
(0)	(1)	(2)	(3)	(4)	(5)	(6)	(7)	(8)	(9)	(10)	(11)	(12)	(13)	(14)	(15)	(pointer No.)		
624	628	632	636	640	644	648	652	656	660	664	668	672	676	680	684	Md.19	Axis in which the error occurred	
625	629	633	637	641	645	649	653	657	661	665	669	673	677	681	685	Md.20	Axis error No.	
626	630	634	638	642	646	650	654	658	662	666	670	674	678	682	686	Md.21	Axis error occurrence time (Hour: minute)	
627	631	635	639	643	647	651	655	659	663	667	671	675	679	683	687	Md.22	Axis error occurrence time (Second: 100ms)	
688																Md.23	Error history pointer	
(0)	(1)	(2)	(3)	(4)	(5)	(6)	(7)	(8)	(9)	(10)	(11)	(12)	(13)	(14)	(15)	(pointer No.)		
689	693	697	701	705	709	713	717	721	725	729	733	737	741	745	749	Md.24	Axis in which the warning occurred	
690	694	698	702	706	710	714	718	722	726	730	734	738	742	746	750	Md.25	Axis warning No.	
691	695	699	703	707	711	715	719	723	727	731	735	739	743	747	751	Md.26	Axis warning occurrence time (Hour: minute)	
692	696	700	704	708	712	716	720	724	728	732	736	740	744	748	752	Md.27	Axis warning occurrence time (Second: 100ms)	
753																Md.28	Warning history pointer	

Buffer memory address			Item	Memory area
Axis 1	Axis 2	Axis 3		
800	900	1000	Md.29	Axis monitor data Monitor data
801	901	1001		
			Current feed value	
802	902	1002	Md.30	
803	903	1003		
			Machine feed value	
804	904	1004	Md.31	
805	905	1005		
			Feedrate	
806	906	1006	Md.32	
			Valid M code	
807	907	1007	Md.33	
			Axis error No.	
808	908	1008	Md.34	
			Axis warning No.	
809	909	1009	Md.35	
			Axis operation status	
810	910	1010	Md.36	
811	911	1011		
			Current speed	
812	912	1012	Md.37	
813	913	1013		
			Axis feedrate	
814	914	1014	Md.38	
815	915	1015		
			Speed/position changeover control positioning amount	
816	916	1016	Md.39	
			External input/output signal	
817	917	1017	Md.40	
			Status	
818	918	1018	Md.41	
819	919	1019		
			Target value	
820	920	1020	Md.42	
821	921	1021		
			Target speed	
822	922	1022	Md.43	
823	923	1023		
			Zero point absolute position	
824	924	1024	Md.44	
825	925	1025		
			Movement amount after near-point dog ON	
826	926	1026	Md.45	
			Torque limit stored value	
827	927	1027	Md.46	
			Special start data command code setting value	
828	928	1028	Md.47	
			Special start data command parameter setting value	
829	929	1029	Md.48	
			Start positioning data No. setting value	
830	930	1030	Md.49	
			In speed limit flag	
831	931	1031	Md.50	
			In speed change processing flag	
832	932	1032	Md.51	
			Start data pointer being executed	
833	933	1033	Md.52	
			Last executed positioning data No.	
834	934	1034	Md.53	
			Repeat counter	
835	935	1035	Md.54	
			Positioning data No. being executed	
836	936	1036	Md.55	
			Block No. being executed	
838 to 847	938 to 947	1038 to 1047	Md.56	
			Positioning data being executed	

Buffer memory address			Item	Memory area
Axis 1	Axis 2	Axis 3		
	1100		Cd.1 Clock data setting (hour)	System control data
	1101		Cd.2 Clock data setting (minute, second)	
	1102		Cd.3 Clock data writing	
	1103		Cd.4 Target axis	
	1104		Cd.5 Positioning data No.	
	1105		Cd.6 Write pattern	
	1106		Cd.7 Read/write request	
	1108 to 1137		Cd.8 Read/write positioning data I/F	
	1138		Cd.9 Flash ROM write request	
	1139		Cd.10 Parameter initialization request	
1150	1200	1250	Cd.11 Positioning start No.	Axis control data
1151	1201	1251	Cd.12 Axis error reset	
1152	1202	1252	Cd.13 Restart command	
1153	1203	1253	Cd.14 M code OFF request	
1154	1204	1254	Cd.15 New current value	
1155	1205	1255		
1156	1206	1256	Cd.16 New speed value	
1157	1207	1257		
1158	1208	1258	Cd.17 Speed change request	
1159	1209	1259	Cd.18 Positioning operation speed override	
1160	1210	1260	Cd.19 JOG speed	
1161	1211	1261		
1163	1213	1253	Cd.20 Speed/position changeover enable flag	
1164	1214	1264	Cd.21 Speed/position changeover control movement amount change register	
1165	1215	1265		
1167	1217	1267	Cd.22 Manual pulse generator enable flag	
1168	1218	1268	Cd.23 Manual pulse generator 1 pulse input magnification	
1169	1219	1269		
1170	1220	1270	Cd.24 Zero point return request flag OFF request	
1171	1221	1271	Cd.25 External start valid	
1172	1222	1272	Cd.26 Step valid flag	
1173	1223	1273	Cd.27 Step mode	
1174	1224	1274	Cd.28 Step start information	
1175	1225	1275	Cd.29 Skip command	
1176	1226	1276	Cd.30 New torque value	
1178	1228	1278	Cd.31 Positioning starting point No.	
1181	1231	1281	Cd.32 Interrupt request during continuous operation	
1184	1234	1284	Cd.33 New acceleration time value	
1185	1235	1285		
1186	1236	1286	Cd.34 New deceleration time value	
1187	1237	1287		
1188	1238	1288	Cd.35 Acceleration/deceleration time change during speed change, enable/disable selection	

Buffer memory address						Item	Memory area
Axis 1		Axis 2		Axis 3			
1300		2300		3300		Da.1 Operation pattern Da.2 Control method Da.3 Acceleration time No. Da.4 Deceleration time No.	No. 1 Positioning data
1301		2301		3301		Da.9 M code/condition data No.	
1302		2302		3302		Da.8 Dwell time/JUMP destination positioning data No.	
1303		2303		3303		Not used	
1304 1305		2304 2305		3304 3305		Da.7 Command speed	
1306 1307		2306 2307		3306 3307		Da.5 Positioning address/movement amount	
1308 1309		2308 2309		3308 3309		Da.6 Arc address	
1310 to 1319		2310 to 1219		3310 to 3319		No. 2	
1320 to 1329		2320 to 2329		3320 to 3329		No. 3	
↓		↓		↓		↓	
2290 to 2299		3290 to 3299		4290 to 3299		No. 100	
4300	4350	4550	4600	4800	4850	Da.10 Shape Da.11 Start data No. Da.12 Special start command Da.13 Parameter	1st point Start block data
4301	4351	4551	4601	4801	4851	2nd point	
4302	4352	4552	4602	4802	4852	3rd point	
↓	↓	↓	↓	↓	↓	↓	
4349	4399	4599	4649	4849	4899	50th point	
4400		4650		4900		Da.14 Condition target Da.15 Condition operator	No. 1 Condition data Positioning start information
4402 4403		4652 4653		4902 4903		Da.16 Address	
4404 4405		4654 4655		4904 4905		Da.17 Parameter 1	
4406 4407		4656 4657		4906 4907		Da.18 Parameter 2	
4410 to 4419		4660 to 4669		4910 to 4919		No. 2	
4420 to 4429		4670 to 4679		4920 to 4929		No. 3	
↓		↓		↓		↓	
4490 to 4499		4740 to 4749		4990 to 4999		No. 10	

Buffer memory address			Item	Memory area		
Axis 1	Axis 2	Axis 3		Indirectly specification data	Positioning start information	Positioning data
4500	5750	5000	Start No. 8001			
4501	4751	5001	Start No. 8002			
↓	↓	↓	↓			
4549	4799	5049	Start No. 8001	PLC CPU memory area		
5050			Condition judgment target data of the condition data			
↓						
5099						
5100			Target axis	Block transmission area		
5101			Head positioning data No.			
5102			No. of read/write data			
5103			Read/write request			
5110 to 6109			Read/write block			

INDEX

[Number]

1-2 PHASE EXCITATION SYSTEM	
(explanation of terms)	Appendix-26
1-axis fixed-dimension feed control	9-29
1-axis linear control (ABS linear 1)	9-23
1-axis linear control (INC linear 1)	9-24
101 to 600 positioning data No. setting	7-8,13
17-segment LED	4-3
2-PHASE EXCITATION SYSTEM	
(explanation of terms)	Appendix-26
2-PHASE PULSE (explanation of terms)	
.....	Appendix-26
2-SPEED TRAPEZOIDAL CONTROL	
(explanation of terms)	Appendix-26
2-axis circular interpolation control with auxiliary point designation (ABS circular interpolation)	
.....	9-33
2-axis circular interpolation control with auxiliary point designation (INC circular interpolation)	
.....	9-36
2-axis circular interpolation control with center point designation (ABS right arc, ABS left arc)	
.....	9-41
2-axis circular interpolation control with center point designation (INC right arc, INC left arc)	
.....	9-43
2-axis fixed-dimension feed control (interpolation)	
.....	9-31
2-axis linear interpolation control (ABS linear 2)	
.....	9-25
2-axis linear interpolation control (INC linear 2)	
.....	9-27

[A]

A phase/B phase mode	5-22
ABSOLUTE ENCODER (explanation of terms)	
.....	Appendix-27
ABSOLUTE POSITION DETECTION SYSTEM	
(explanation of terms)	Appendix-27
ABSOLUTE SYSTEM (explanation of terms)	
.....	Appendix-27
ACCELERATION TIME (explanation of terms)	
.....	Appendix-27
AD75	A-16
AD75 READY signal	3-13

AD75 software package	A-16,2-4
ADDRESS (explanation of terms)	Appendix-27
AFTER mode	12-59
AFTER mode (explanation of terms)	
.....	Appendix-27
AUTO TUNING (explanation of terms)	
.....	Appendix-28
AUTOMATIC TRAPEZOIDAL ACCELERATION/ DECELERATION (explanation of terms)	
.....	Appendix-28
Absolute system	9-14
Acceleration / deceleration time change program	
.....	6-17
Acceleration time 0 ([Pr.8])	5-24
Acceleration time 1 ([Pr.26])	5-36
Acceleration time 2 ([Pr.27])	5-36
Acceleration time 3 ([Pr.28])	5-36
Acceleration time No. ([Da.3])	5-59
Acceleration/deceleration process selection ([Pr.35])	5-38
Acceleration/deceleration processing function	
.....	12-78
Acceleration/deceleration time change during speed change, enable/disable selection ([Cd.35])	
.....	5-122
Acceleration/deceleration time change function	
.....	12-45
Actual acceleration/deceleration time	5-25
Address ([Da.16])	5-80
Advanced positioning control	10-2
Allowable circular interpolation error width ([Pr.42])	5-43
Applicable system	2-5
Applicable wire size	3-3
Arc address ([Da.6])	5-64
Assembling the connector section	4-16
Automatic trapezoidal acceleration/deceleration processing method	12-79
Auxiliary functions	12-2
Auxiliary functions specifically for machine zero point returns	12-4
Axis display LED	4-4
Axis error No. ([Md.20], [Md.33])	5-88,92
Axis error occurrence time (Hour: minute) ([Md.21])	5-88

Axis error occurrence time (Second: 100 ms) (Md.22)	5-88
Axis error reset (Cd.12)	5-112
Axis feedrate (Md.37)	5-96
Axis in which the error occurred (Md.19)	5-88
Axis in which the warning occurred (Md.24)	5-90
Axis monitor data	5-92
Axis operation status (Md.35)	5-94
Axis stop signal	3-15
Axis warning No. (Md.25 , Md.34)	5-90,94
Axis warning detection	5-98
Axis warning occurrence time (Hour: minute) (Md.26)	5-90
Axis warning occurrence time (Second: 100 ms) (Md.27)	5-90

[B]

BACKLASH COMPENSATION

(explanation of terms) Appendix-28

BACKUP FUNCTION (explanation of terms)

..... Appendix-28

BALL SCREW (explanation of terms)

..... Appendix-28

BIAS SPEED AT START (explanation of terms)

..... Appendix-29

BIPOLAR DRIVE CONSTANT-CURRENT

SYSTEM (explanation of terms) Appendix-29

BUSY (explanation of terms) Appendix-29

BUSY signal
 3-13 |

Backlash compensation amount ([Pr.12](#)) ...

 5-28 |

Backlash compensation function

 12-11 |

Basic parameters 1

 5-18 |

Basic parameters 2

 5-24 |

Bias speed at start ([Pr.10](#))

 5-25 |

Block

 10-8 |

Block No. being executed ([Md.55](#))

 5-104 |

Block start (normal start)

 10-8 |

Block transmission

 7-13 |

Block transmission area

 7-3 |

Buffer memory

 7-2 |

Buffer memory area configuration

 7-5 |

[C]

CCW (explanation of terms) Appendix-29

CHANGE signal (explanation of terms)

..... Appendix-29

CIRCULAR INTERPOLATION

(explanation of terms) Appendix-29

COMMAND PULSE (explanation of terms)

..... Appendix-29

COMPOSITE SPEED (explanation of terms)

..... Appendix-29

CONTINUOUS POSITIONING CONTROL

(explanation of terms) Appendix-29

CONTROL UNIT (explanation of terms)

..... Appendix-29

CP CONTROL (explanation of terms)

..... Appendix-29

CPU module

 2-5 |

CREEP SPEED (explanation of terms)

..... Appendix-30

CURRENT FEED VALUE (explanation of terms)

..... Appendix-30

CURRENT LOOP MODE (explanation of terms)

..... Appendix-30

CURRENT VALUE (explanation of terms)

..... Appendix-30

CURRENT VALUE CHANGE

(explanation of terms) Appendix-30

CW (explanation of terms)..... Appendix-30

CW/CCW mode

 5-22 |

Cable clamp

 4-10 |

Cable fixture

 4-13 |

Clock data (hour: minute) ([Md.5](#))

 5-82 |

Clock data (second: 100 ms) ([Md.6](#))

 5-82 |

Clock data function

 13-11 |

Clock data setting (hour) ([Cd.1](#))

 5-106 |

Clock data setting (minute, second) ([Cd.2](#))
.....

 5-106 |

Clock data setting program.....

 6-14 |

Clock data writing ([Cd.3](#))

 5-106 |

Combination of AD75 functions.....

 3-10 |

Combination of main functions and auxiliary
functions

 3-10 |

Command in-position flag.....

 5-98 |

Command in-position function.....

 12-72 |

Command in-position width ([Pr.17](#)).....

 5-30 |

Command pulse frequency

 1-9 |

Command speed ([Da.7](#))

 5-68 |

Common functions.....

 3-9,13-1 |

Communicating signals between AD75 and each
module.....

 1-10 |

Composite speed

 5-34 |

Condition data

 10-17 |

Index - 2

Condition operator	10-18
Condition operator ([Da.15])	5-80
Condition start	10-10
Condition target ([Da.14])	5-80
Conditional JUMP	9-60
Configuration and roles of AD75 memory	7-2
Confirming the current value	9-15
Confirming the installation and wiring	4-18
Conformation to the EMC Directive and Low Voltage Instruction	A-12
Connecting the connector	4-17
Connecting the connector and wire	4-14
Connection confirmation	4-18
Connection connector	3-3
Connector	4-13
Connector cover	4-13
Continuous operation interrupt program	6-19
Continuous path control	9-7
Continuous positioning control	9-6
Control data area	7-3
Control functions	3-4
Control method ([Da.2])	5-59
Count method 1) zero point return	8-16
Count method 2) zero point return	8-18
Creep speed ([Pr.49])	5-50
Current feed value	9-15
Current feed value ([Md.29])	5-92
Current feed value during speed control ([Pr.22])	5-34
Current speed ([Md.36])	5-94
Current value change	9-55

[D]

D/A CONVERTER (explanation of terms)	Appendix-30
DATA NO. (explanation of terms)	Appendix-30
DECELERATION RATIO (explanation of terms)	Appendix-30
DECELERATION TIME (explanation of terms)	Appendix-31
DEVIATION COUNTER (explanation of terms)	Appendix-31
DIFFERENTIAL OUTPUT TYPE (explanation of terms)	Appendix-31
DIGITAL BUS CONNECTION (explanation of terms)	Appendix-31
DOG SIGNAL (explanation of terms)	Appendix-31

DOS/V personal computer	A-16
DRIVE UNIT (explanation of terms)	Appendix-31
DRIVE UNIT READY (explanation of terms)	Appendix-31
DROOP PULSE (explanation of terms)	Appendix-32
DWELL TIME (explanation of terms)	Appendix-32
DYNAMIC BRAKE (explanation of terms)	Appendix-32
Data link system	A-16
Data transmission process	7-6
Deceleration stop	6-37
Deceleration time 0 ([Pr.9])	5-24
Deceleration time 1 ([Pr.29])	5-36
Deceleration time 2 ([Pr.30])	5-36
Deceleration time 3 ([Pr.31])	5-36
Deceleration time No. ([Da.4])	5-59
Detailed parameters 1	5-28
Detailed parameters 2	5-36
Details of input signals (AD75 → PLC CPU)	3-13
Details of output signals (PLC CPU → AD75)	3-15
Deviation counter clear	3-19
Deviation counter droop pulse amount	1-9
Disassembling the connector section	4-13
Disposal instructions	4-23
Drive unit	A-16
Drive unit READY	3-19
Dwell time/JUMP designation positioning data No. ([Da.8])	5-70
Dwell time during zero point return retry ([Pr.58])	5-55

[E]

ELECTROMAGNETIC BRAKE (explanation of terms)	Appendix-32
ELECTRONIC GEAR (explanation of terms)	Appendix-32
EMERGENCY STOP (explanation of terms)	Appendix-32
ENCODER (explanation of terms)	Appendix-32
ERROR CORRECTION (explanation of terms)	Appendix-33

ERROR RESET (explanation of terms)	Appendix-33
EXTERNAL REGENERATIVE BRAKE RESISTOR (explanation of terms)	Appendix-33
Electrical specifications	3-16
Electronic gear function	12-13
Emergency stop	6-36
Error and warning details	14-2
Error compensation method	12-14
Error detection signal	3-13
Error history pointer (Md.23)	5-88
Error judgment (Md.11, Md.17)	5-84,86
Error reset program	6-20
Execution data backup function	13-5
External device connection connector	4-4
External dimension drawing	Appendix-2
External input/output signal (Md.39)	5-96
External start signal	3-19
External start function selection (Pr.43)	5-44
External start function valid setting program	6-14
External start valid (Cd.25)	5-118
[F]	
F (explanation of terms)	Appendix-33
FEED PULSE (explanation of terms)	Appendix-33
FEEDBACK PULSE (explanation of terms)	Appendix-33
FIXED-DIMENSION FEED (explanation of terms)	Appendix-33
FLASH MEMORY (explanation of terms)	Appendix-33
FLS SIGNAL (explanation of terms)	Appendix-33
Fatal stop	6-36
Features of AD75	1-2
Feedrate (Md.31)	5-92
Ferrite core	4-10
Flash ROM	7-2
Flash ROM write program	6-19
Flash ROM write request (Cd.9)	5-110
Flow of all processes	1-12
Flow of system operation	1-12
Forced stop	6-36
Front-loading speed changeover mode	9-12
Functions for compensating the control	12-11

Functions to change the control details	12-35
Functions to limit the control	12-22
[G]	
GAIN (explanation of terms)	Appendix-33
General configuration of program	6-8
General image of system	2-2
General specifications	3-2
[H]	
HIGH-SPEED MACHINE ZERO POINT RETURN (explanation of terms)	Appendix-34
High-speed machine zero point return	8-22
HIGH-SPEED ZERO POINT RETURN (explanation of terms)	Appendix-34
Handling precautions	4-5
Hardware stroke limit function	12-33
High-speed zero point return	8-20
[I]	
I/F	A-16
INCREMENT SYSTEM (explanation of terms)	Appendix-34
INCREMENTAL ENCODER (explanation of terms)	Appendix-34
INERTIA (explanation of terms)	Appendix-34
INPUT TERMINAL (explanation of terms)	Appendix-34
INTERLOCK (explanation of terms)	Appendix-35
INTERPOLATION OPERATION (explanation of terms)	Appendix-35
INVERTER (explanation of terms)	Appendix-35
Immediate stop	6-37
In speed change processing flag (Md.50)	5-102
In speed control flag	5-98
In speed limit flag (Md.49)	5-102
In test mode flag (Md.1)	5-82
In-position	3-19
Increment system	9-14
Independent positioning control	9-5
Indirectly specification data	12-82
Indirectly specification function	12-82
Initialization program	6-21
Input/output information n	13-9
Input/output interface internal circuit	3-21

Intentional stop	6-36
Internal circuit	3-21
Internal current consumption	3-3
Internal information 1	13-8
Internal information 2	13-8
Interpolation axis	9-19
Interpolation control.....	9-19
Interpolation speed designation method ([Pr.21])	5-34
Interrupt request during continuous operation ([Cd.32]).....	5-122
[J]	
JOG (explanation of terms).....	Appendix-35
JOG operation	11-4
JOG operation acceleration time selection ([Pr.33]).....	5-37
JOG operation deceleration time selection ([Pr.34]).....	5-37
JOG operation program	6-16
JOG operation start time chart.....	11-11
JOG operation timing and processing times	11-6
JOG speed ([Cd.19]).....	5-116
JOG speed limit value ([Pr.32]).....	5-37
JOG start signal.....	3-15
JUMP command.....	9-60
[K]	
kPPS (explanation of terms).....	Appendix-35
[L]	
LED display function	13-7
LIMIT SWITCH (explanation of terms)	Appendix-35
LINEAR INTERPOLATION (explanation of terms)	Appendix-35
LOW-INERTIA MOTOR (explanation of terms)	Appendix-36
Last executed positioning data No.([Md.52])	5-104
List of condition data	5-77
List of configuration devices.....	2-4
List of control data	5-106
List of devices.....	6-4
List of errors.....	14-6
List of functions.....	3-4
List of input/output signal details.....	3-19

List of input/output signals	3-12
List of monitor data	5-82
List of parameters	5-18
List of positioning data	5-56
List of start block data.....	5-71
List of warnings	14-30
Logic selection for pulse output to the drive unit ([Pr.24]).....	5-35
Lower limit signal	3-20
[M]	
M CODE (explanation of terms).....	Appendix-36
M code OFF request.....	12-59
M code OFF request ([Cd.14]).....	5-112
M code ON signal	3-13
M code ON signal output timing ([Pr.19]).....	5-32
M code ON/OFF timing.....	12-58
M code output function	12-58
M code/condition data No. ([Da.9]).....	5-68
MACHINE FEED VALUE (explanation of terms)	Appendix-36
MANUAL PULSE GENERATOR (explanation of terms).....	Appendix-36
MASTER AXIS (explanation of terms)	Appendix-36
MOVEMENT AMOUNT PER PULSE (explanation of terms).....	Appendix-36
MULTI-PHASE PULSE (explanation of terms)	Appendix-36
MULTIPLYING RATE SETTING (explanation of terms).....	Appendix-36
Machine feed value.....	9-15
Machine feed value ([Md.30]).....	5-92
Machine zero point return.....	8-4
Machine zero point return method	8-5
Main functions	3-6
Main positioning control	9-2
Manual control	11-2
Manual pulse generator.....	A-16,2-4
Manual pulse generator 1 pulse input magnification ([Cd.23]).....	5-118
Manual pulse generator enable flag ([Cd.22])	5-118
Manual pulse generator operation	11-17
Manual pulse generator operation program	6-16
Manual pulse generator operation start time chart	11-24

Manual pulse generator operation timing and processing times	11-19
Manual pulse generator selection ([Pr.23])	5-35
Max. connection distance	3-3
Max. output pulse	3-3
Mechanism of positioning control	1-6
Mode switch.....	4-4
Module name ([Md.2])	5-82
Module version label	4-4
Monitor data area	7-3
Movement amount after near-point dog ON ([Md.44])	5-100
Movement amount per pulse ([Pr.2] to [Pr.4])	5-19
Movement amount per rotation ([Pr.3]).....	5-20

[N]

NEAR-POINT DOG (explanation of terms)	Appendix-37
NEXT start	10-16
Names of each part.....	4-3
Near pass mode	12-18
Near pass mode function	12-18
Near pass mode selection for path control ([Pr.44])	5-44
Near-point dog method zero point return	8-6
Near-point dog signal	3-20
Network system.....	A-16
New acceleration time value ([Cd.33]).....	5-122
New current value ([Cd.15])	5-114
New deceleration time value ([Cd.34])	5-122
New speed value ([Cd.16]).....	5-114
New torque value ([Cd.30])	5-120
No. of control axes	3-3
No. of mounted modules.....	2-6
No. of occupied input/output points	3-3
No. of pulses per rotation ([Pr.2]).....	5-19
No. of slots.....	2-6
Normal start	10-8

[O]

OPERATION PATTERN (explanation of terms)	Appendix-37
OS memory	7-2
OS type ([Md.3]).....	5-82
OS version ([Md.4]).....	5-82

OUTPUT TERMINAL (explanation of terms)	Appendix-37
OVERRIDE FUNCTION (explanation of terms)	Appendix-37
Operation monitor 1	13-8
Operation monitor 2	13-8
Operation pattern ([Da.1]).....	5-59
Operation patterns	9-4
Operation timing and processing time during speed/position changeover control	9-50
Operation timing and processing time of high-speed zero point returns	8-21
Operation type ([Md.8] , [Md.14])	5-84,86
Order of priority for stop process.....	6-38
Outline design of positioning system.....	1-8
Outline for restarting	1-17
Outline of installation, wiring and maintenance	4-2
Outline of starting.....	1-14
Outline of stopping	1-16
Outline of zero point return control	8-2
Override function.....	12-42
Override program.....	6-17

[P]

P RATE (explanation of terms).....	Appendix-37
PANCAKE MOTOR (explanation of terms)	Appendix-37
PARAMETER (explanation of terms)	Appendix-37
PLC CPU.....	A-16
PLC CPU memo area.....	7-3
PLC READY signal	3-15
PLC READY signal [Y1D] ON program	6-14
POSITION CONTROL (explanation of terms)	Appendix-37
POSITION DETECTION MODULE (explanation of terms)	Appendix-38
POSITION LOOP GAIN (explanation of terms)	Appendix-38
POSITION LOOP MODE (explanation of terms)	Appendix-38
POSITIONING (explanation of terms)	Appendix-38
POSITIONING COMPLETE SIGNAL (explanation of terms).....	Appendix-38
POSITIONING DATA (explanation of terms)	Appendix-38

POSITIONING PARAMETER (explanation of terms).....	Appendix-38
POSITIONING START (explanation of terms)	Appendix-39
PTP Control (explanation of terms)	Appendix-39
PU (explanation of terms)	Appendix-39
PULSE (explanation of terms)	Appendix-39
PULSE GENERATOR (explanation of terms)	Appendix-39
PULSE OUTPUT MODE (explanation of terms)	Appendix-39
PULSE/SIGN mode.....	5-21
Parameter ([Da.13]).....	5-75
Parameter 1 ([Da.17]).....	5-81
Parameter 2 ([Da.18]).....	5-81
Parameter area	7-3
Parameter initialization program	6-19
Parameter initialization request ([Cd.10])	5-110
Parameter setting program	6-12
Performance specifications	3-3
Peripheral device connection connector	4-4
Personal computer	A-16
Positioning start information setting program	6-13
Positioning address pass mode.....	12-19
Positioning address/movement amount ([Da.5])	5-60
Positioning complete	9-5
Positioning complete signal	3-13
Positioning complete signal output time ([Pr.41])	5-42
Positioning control operation program.....	6-9
Positioning data No. ([Cd.5]).....	5-108
Positioning data No. 101 to 600 setting.....	7-8,13
Positioning data No. being executed ([Md.54])	5-104
Positioning data area (No. 1 to 100).....	7-3
Positioning data area (No. 101 to 600).....	7-3
Positioning data being executed ([Md.56])	5-104
Positioning data setting program	6-12
Positioning operation speed override ([Cd.18])	5-114
Positioning program examples	6-12
Positioning start No. ([Cd.11]).....	5-112
Positioning start No. setting program	6-14

Positioning start information area (No.7000)	7-3
Positioning start information area (No.7001 to 7010).....	7-3
Positioning start signal.....	3-15
Positioning start signal input program.....	6-15
Positioning starting point No. ([Cd.31])	5-120
Positioning to the zero point	8-22
Precautions according to module version	2-6
Precautions for configuring system	2-6
Precautions for creating program.....	6-2
Precautions for installation	4-7
Precautions for maintenance.....	4-23
Precautions for mounting.....	4-7
Precautions for mounting base unit.....	2-6
Precautions for using 3-axis module	2-7
Precautions for using stepping motor	2-7
Precautions for wiring	4-8
Precautions	
Disposal instructions	4-23
according to module version.....	2-6
for creating program.....	6-2
for installation	4-7
for maintenance	4-23
for mounting	4-7
for mounting base unit	2-6
for using 3-axis module.....	2-7
for using stepping motor	2-7
for wiring	4-8
Handling	4-5
Principle of operation	1-7
Process time	
JOG operation timing and processing times	11-6
Machine zero point return operation timing and process time	6-28
Manual pulse generator operation timing and processing times	11-19
Operation timing and processing time during speed/position changeover control.....	9-50
Operation timing and processing time of high-speed zero point returns	8-21
Position control operation timing and process time	6-29
Program details	6-21
Program examples	
Acceleration / deceleration time change program	6-17

Clock data setting program	6-14
Continuous operation interrupt program...	6-19
Error reset program	6-20
External start function valid setting program	6-14
Flash ROM write program	6-19
JOG operation program	6-16
Manual pulse generator operation program	6-16
Override program	6-17
PLC READY signal [Y1D] ON program....	6-14
Parameter initialization program	6-19
Parameter setting program	6-12
Positioning start information setting program	6-13
Positioning data setting program	6-12
Positioning start No. setting program.....	6-14
Positioning start signal input program.....	6-15
Reset program	6-16
Restart program.....	6-19
Skip program	6-18
Speed change program.....	6-17
Step operation program	6-18
Stop program	6-20
Teaching program	6-18
Torque change program.....	6-17
Zero point return request OFF program ...	6-13
Pulse encoder	1-9
Pulse output mode ([Pr.5]).....	5-21
Purpose and applications of positioning control	1-4

[R]

READY (explanation of terms).....	Appendix-39
REAL-TIME AUTO TUNING (explanation of terms)	Appendix-39
REFERENCE AXIS SPEED (explanation of terms)	Appendix-39
REGENERATIVE BRAKE OPTION (explanation of terms)	Appendix-39
RESOLVER (explanation of terms)	Appendix-40
RLS SIGNAL (explanation of terms)	Appendix-40
ROTARY TABLE (explanation of terms)	Appendix-40
RS-422 cable.....	2-4
Read/write positioning data I/F ([Cd.8])....	5-110

Read/write request ([Cd.7])	5-108
Reference axis	9-19
Reference axis speed	5-34
Relatively safe stop.....	6-36
Remote I/O station	2-5
Repeat counter ([Md.53])	5-104
Repeated start (FOR condition)	10-15
Repeated start (FOR loop)	10-14
Reset program	6-16
Restart command ([Cd.13])	5-112
Restart operation	6-33
Restart program	6-19
Rotation direction setting ([Pr.6]).....	5-23

[S]

S-CURVE ACCELERATION/DECELERATION (explanation of terms).....	Appendix-40
S-curve acceleration/deceleration processing method	12-80
S-curve ratio ([Pr.36]).....	5-39
SERVO AMPLIFIER (explanation of terms)	Appendix-40
SERVO LOCK (explanation of terms)	Appendix-40
SERVO ON (explanation of terms)	Appendix-40
SERVOMOTOR (explanation of terms)	Appendix-40
SETTING UNIT (explanation of terms)	Appendix-41
SKIP FUNCTION (explanation of terms)	Appendix-41
SLAVE AXIS (explanation of terms)	Appendix-41
SPEED CHANGEOVER CONTROL (explanation of terms).....	Appendix-41
SPEED CONTROL (explanation of terms)	Appendix-41
SPEED INTEGRAL COMPENSATION (explanation of terms).....	Appendix-41
SPEED LIMIT VALUE (explanation of terms)	Appendix-41
SPEED LOOP GAIN (explanation of terms)	Appendix-41
SPEED LOOP MODE (explanation of terms)	Appendix-41
SPEED/POSITION CONTROL CHANGEOVER MODE (explanation of terms).....	Appendix-41

START COMPLETE (explanation of terms)	Appendix-42	Size selection for acceleration/deceleration time (Pr.25).....	5-35
STARTING AXIS.....	Appendix-42	Skip command (Cd.29).....	5-120
STATUS (explanation of terms).....	Appendix-42	Skip function.....	12-55
STEP FUNCTION (explanation of terms)	Appendix-42	Skip program.....	6-18
STEP OUT (explanation of terms)	Appendix-42	Software stroke limit lower limit value (Pr.14)	5-29
STEPPING MOTOR (explanation of terms)	Appendix-42	Software stroke limit selection (Pr.15).....	5-30
STOP SETTLING TIME (explanation of terms)	Appendix-42	Software stroke limit upper limit value (Pr.13)	5-29
STOP SIGNAL (explanation of terms)	Appendix-42	Software stroke limit valid/invalid setting (Pr.16)	5-30
STOPPER STOP (explanation of terms)	Appendix-43	Special start command (Da.12).....	5-74
STROKE (explanation of terms).....	Appendix-43	Special start data command code setting value (Md.46).....	5-102
STROKE LIMIT (explanation of terms)	Appendix-43	Special start data command parameter setting value (Md.47).....	5-102
SUDDEN STOP (explanation of terms)	Appendix-43	Specifications of input/output interfaces	3-16
Setting data	5-2	Specifications of input/output signals	3-12
Setting for the movement amount after near-point dog ON (Pr.52).....	5-52	Speed change 0 flag.....	5-98
Setting items for condition data	5-10	Speed change function.....	12-35
Setting items for positioning data.....	5-7	Speed change program.....	6-17
Setting items for positioning parameters	5-4	Speed change request (Cd.17).....	5-114
Setting items for start block data	5-9	Speed changeover mode (Pr.20).....	5-33
Setting items for zero point return parameters	5-6	Speed control.....	9-46
Setting the positioning data.....	9-22	Speed designation during zero point shift (Pr.57).....	5-55
Setting the torque limit function	12-26	Speed limit function	12-22
Shape (Da.10).....	5-74	Speed limit value (Pr.7).....	5-24
Signal layout for connector	3-18	Speed/position changeover control.....	9-48
Signal name.....	3-13	Speed/position changeover control movement amount change register (Cd.21).....	5-116
Signal		Speed/position changeover control positioning amount (Md.38).....	5-96
AD75 READY signal.....	3-13	Speed/position changeover enable flag (Cd.20)	5-116
Axis stop signal.....	3-15	Speed/position changeover latch flag	5-98
BUSY signal.....	3-13	Speed/position changeover signal	3-18
Error detection signal	3-13	Spiral interpolation	9-40
JOG start signal.....	3-15	Standard speed changeover mode.....	9-11
M code ON signal.....	3-13	Start axis (Md.7, Md.13).....	5-84,86
PLC READY signal.....	3-15	Start block data	10-7
Positioning complete signal.....	3-13	Start complete signal	3-13
Positioning start signal	3-15	Start data No. (Da.11).....	5-74
Start complete signal.....	3-13	Start data pointer being executed (Md.51)	5-104
Simultaneous start.....	10-12	Start details setting program.....	6-22
Single module test.....	4-19	Start during error history	14-36

Start positioning data No. setting value (Md.48)	5-102
Start program	6-23
Start program for advanced positioning control	10-20
Start time (Hour: minute) (Md.9, Md.15)	5-84,86
Start time (Second:100 ms) (Md.10, Md.16)	5-84,86
Start time chart for positioning control using indirectly specification function	12-86
Start time chart for positioning to the zero point	8-23
Starting history pointer (Md.12)	5-84
Starting history pointer at error (Md.18)	5-86
Status (Md.40)	5-98
Step function	12-50
Step mode	12-51
Step mode (Cd.27)	5-120
Step operation program	6-18
Step start information	12-51
Step start information (Cd.28)	5-120
Step valid flag (Cd.26)	5-118
Stepping motor mode function	12-75
Stepping motor mode selection (Pr.11)	5-26
Stop	10-13
Stop cause	6-36
Stop group 1 sudden stop selection (Pr.38)	5-41
Stop group 2 sudden stop selection (Pr.39)	5-41
Stop group 3 sudden stop selection (Pr.40)	5-41
Stop process	6-36
Stop program	6-20
Stop signal	3-19
Stopper stop method 1) zero point return	8-8
Stopper stop method 2) zero point return	8-11
Stopper stop method 3) zero point return	8-14
Sudden stop	6-37
Sudden stop deceleration time (Pr.37)	5-40
System control data	5-106
System monitor data	5-82

TEACHING UNIT (explanation of terms)	Appendix-43
TORQUE CONTROL (explanation of terms)	Appendix-43
TORQUE LOOP MODE (explanation of terms)	Appendix-43
TORQUE RIPPLE (explanation of terms)	Appendix-44
TRACKING FUNCTION (explanation of terms)	Appendix-44
TURNTABLE (explanation of terms)	Appendix-44
Target axis (Cd.4)	5-106
Target speed (Md.42)	5-100
Target value (Md.41)	5-98
Teaching function	12-62
Teaching program	6-18
Teaching unit	2-4
Time chart for changing the speed from the PLC CPU	12-38
Time chart for changing the speed using an external start signal	12-40
Time chart for changing the speed using the override function	12-43
Time chart for restarting	6-35
Time chart for starting high-speed zero point return	6-26
Time chart for starting machine zero point return	6-25
Time chart for starting main positioning control	6-27
Time chart for starting speed/position changeover control	6-27
Time chart for starting with external start signal	6-30
Time chart	
for positioning control using indirectly specification function	12-86
for positioning to the zero point	8-23
for restarting	6-35
for starting high-speed zero point return	6-26
for starting machine zero point return	6-25
for starting main positioning control	6-27
for starting speed/position changeover control	6-27
for starting with external start signal	6-30
Torque change function	12-48
Torque change program	6-17

[T]	
TEACHING (explanation of terms)	Appendix-43

Torque limit function	12-24
Torque limit setting value ([Pr.18])	5-31
Torque limit stored value ([Md.45])	5-100
Types and roles of control data	5-14
Types and roles of monitor data	5-11
Types of data	5-2
Types of errors	14-2
Types of stop processes	6-37
Types of warnings	14-3

[U]

UNIT SETTING (explanation of terms)	Appendix-44
Unconditional JUMP	9-60
Unit magnification ([Pr.4])	5-20
Unit setting ([Pr.1])	5-18
Upper limit signal	3-20

[V]

Valid M code ([Md.32])	5-92
--------------------------------	------

[W]

WARNING (explanation of terms) ...	Appendix-44
WITH MODE (explanation of terms)	Appendix-44
WITH mode	12-58
WORM GEAR (explanation of terms)	Appendix-44
Wait start	10-11
Warning history pointer ([Md.28])	5-90
Wiring the connector pins	4-13
Wiring the pins	4-13
Workpiece	A-16
Write pattern ([Cd.6])	5-108
Writing to the flash ROM	13-6

[X]

XY TABLE (explanation of terms)....	Appendix-44
-------------------------------------	-------------

[Z]

Z PHASE (explanation of terms)	Appendix-44
ZERO POINT (explanation of terms)	Appendix-44
ZERO POINT RETURN METHOD (explanation of terms)	Appendix-45
ZERO POINT RETURN PARAMETER (explanation of terms)	Appendix-45

ZERO POINT RETURN REQUEST (explanation of terms)	Appendix-45
ZERO POINT SHIFT FUNCTION (explanation of terms)	Appendix-45
ZERO POINT SIGNAL (explanation of terms)	Appendix-45
Zero point absolute position ([Md.43])	5-100
Zero point absolute position overflow/underflow flag	5-98
Zero point address ([Pr.47])	5-49
Zero point return acceleration time selection ([Pr.53])	5-53
Zero point return basic parameters	5-45
Zero point return complete flag	5-98
Zero point return deceleration time selection ([Pr.54])	5-53
Zero point return detailed parameters	5-52
Zero point return direction ([Pr.46])	5-48
Zero point return dwell time ([Pr.51])	5-52
Zero point return method (1): Near-point dog method	8-6
Zero point return method (2): Stopper stop method 1)	8-8
Zero point return method (3): Stopper stop method 2)	8-11
Zero point return method (4): Stopper stop method 3)	8-14
Zero point return method (5): Count method 1)	8-16
Zero point return method (6): Count method 2)	8-18
Zero point return method ([Pr.45])	5-45
Zero point return request	8-2
Zero point return request OFF program	6-13
Zero point return request flag	5-98
Zero point return request flag OFF request ([Cd.24])	5-118
Zero point return retry ([Pr.50])	5-51
Zero point return retry function	12-4
Zero point return speed ([Pr.48])	5-49
Zero point return torque limit value ([Pr.56])	5-55
Zero point shift amount ([Pr.55])	5-54
Zero point shift function	12-8

WARRANTY

Please confirm the following product warranty details before using this product.

1. Gratis Warranty Term and Gratis Warranty Range

If any faults or defects (hereinafter "Failure") found to be the responsibility of Mitsubishi occurs during use of the product within the gratis warranty term, the product shall be repaired at no cost via the sales representative or Mitsubishi Service Company.

However, if repairs are required onsite at domestic or overseas location, expenses to send an engineer will be solely at the customer's discretion. Mitsubishi shall not be held responsible for any re-commissioning, maintenance, or testing on-site that involves replacement of the failed module.

[Gratis Warranty Term]

The gratis warranty term of the product shall be for one year after the date of purchase or delivery to a designated place.

Note that after manufacture and shipment from Mitsubishi, the maximum distribution period shall be six (6) months, and the longest gratis warranty term after manufacturing shall be eighteen (18) months. The gratis warranty term of repair parts shall not exceed the gratis warranty term before repairs.

[Gratis Warranty Range]

- (1) The range shall be limited to normal use within the usage state, usage methods and usage environment, etc., which follow the conditions and precautions, etc., given in the instruction manual, user's manual and caution labels on the product.
- (2) Even within the gratis warranty term, repairs shall be charged for in the following cases.
 1. Failure occurring from inappropriate storage or handling, carelessness or negligence by the user. Failure caused by the user's hardware or software design.
 2. Failure caused by unapproved modifications, etc., to the product by the user.
 3. When the Mitsubishi product is assembled into a user's device, Failure that could have been avoided if functions or structures, judged as necessary in the legal safety measures the user's device is subject to or as necessary by industry standards, had been provided.
 4. Failure that could have been avoided if consumable parts (battery, backlight, fuse, etc.) designated in the instruction manual had been correctly serviced or replaced.
 5. Failure caused by external irresistible forces such as fires or abnormal voltages, and Failure caused by force majeure such as earthquakes, lightning, wind and water damage.
 6. Failure caused by reasons unpredictable by scientific technology standards at time of shipment from Mitsubishi.
 7. Any other failure found not to be the responsibility of Mitsubishi or that admitted not to be so by the user.

2. Onerous repair term after discontinuation of production

(1) Mitsubishi shall accept onerous product repairs for seven (7) years after production of the product is discontinued.

Discontinuation of production shall be notified with Mitsubishi Technical Bulletins, etc.

(2) Product supply (including repair parts) is not available after production is discontinued.

3. Overseas service

Overseas, repairs shall be accepted by Mitsubishi's local overseas FA Center. Note that the repair conditions at each FA Center may differ.

4. Exclusion of loss in opportunity and secondary loss from warranty liability

Regardless of the gratis warranty term, Mitsubishi shall not be liable for compensation of damages caused by any cause found not to be the responsibility of Mitsubishi, loss in opportunity, lost profits incurred to the user by Failures of Mitsubishi products, special damages and secondary damages whether foreseeable or not, compensation for accidents, and compensation for damages to products other than Mitsubishi products, replacement by the user, maintenance of on-site equipment, start-up test run and other tasks.

5. Changes in product specifications

The specifications given in the catalogs, manuals or technical documents are subject to change without prior notice.

6. Product application

- (1) In using the Mitsubishi MELSEC programmable controller, the usage conditions shall be that the application will not lead to a major accident even if any problem or fault should occur in the programmable controller device, and that backup and fail-safe functions are systematically provided outside of the device for any problem or fault.
- (2) The Mitsubishi programmable controller has been designed and manufactured for applications in general industries, etc. Thus, applications in which the public could be affected such as in nuclear power plants and other power plants operated by respective power companies, and applications in which a special quality assurance system is required, such as for Railway companies or Public service purposes shall be excluded from the programmable controller applications.

In addition, applications in which human life or property that could be greatly affected, such as in aircraft, medical applications, incineration and fuel devices, manned transportation, equipment for recreation and amusement, and safety devices, shall also be excluded from the programmable controller range of applications.

However, in certain cases, some applications may be possible, providing the user consults their local Mitsubishi representative outlining the special requirements of the project, and providing that all parties concerned agree to the special circumstances, solely at the users discretion.

Microsoft Windows, Windows NT are registered trademarks of Microsoft Corporation in the United States and other countries.
Other company and product names herein may be either trademarks or registered trademarks of their respective owners.

A1SD75P1-S3/P2-S3/P3-S3 AD75P1-S3/P2-S3/P3-S3 Positioning Module

User's Manual

MODEL	A1SD75/AD75S3-U-E
MODEL CODE	13J871
IB(NA)-66716-J(0709)MEE	

 **MITSUBISHI ELECTRIC CORPORATION**

HEAD OFFICE : TOKYO BUILDING, 2-7-3 MARUNOUCHI, CHIYODA-KU, TOKYO 100-8310, JAPAN
NAGOYA WORKS : 1-14, YADA-MINAMI 5-CHOME, HIGASHI-KU, NAGOYA, JAPAN

When exported from Japan, this manual does not require application to the
Ministry of Economy, Trade and Industry for service transaction permission.

Specifications subject to change without notice.